

# **TM 9-6625-2467-15**

**DEPARTMENT OF THE ARMY TECHNICAL MANUAL**

**OPERATOR'S, ORGANIZATIONAL, DIRECT SUPPORT, GENERAL SUPPORT,**

**AND DEPOT MAINTENANCE MANUAL**

**(INCLUDING REPAIR PARTS)**

## **SPECTRUM ANALYZER**

**(TEKTRONIX, INC. MODEL 491)**

**(6625-494-2937)**



**HEADQUARTERS, DEPARTMENT OF THE ARMY**

**DECEMBER 1969**

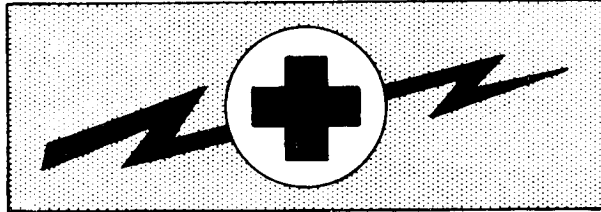

WE 20780

**WARNING**  
**HIGH VOLTAGE**

is used in the operation of this equipment.

**DEATH ON CONTACT**

may result if personnel fail to observe safety precautions.

Learn the areas containing high voltage  
in each piece of equipment.

Be careful not to contact high-voltage or 115-volt ac input connections when installing or operating this equipment.

Before working inside the equipment, turn power off and ground points of high potential before touching them.

This manual contains copyright material  
reproduced by permission of TEKTRONIX, Inc.

TM 9-6625-2467-15

TECHNICAL MANUAL )  
                          )  
No. 9-6625-2467-15 )

HEADQUARTERS  
DEPARTMENT OF THE ARMY  
Washington, D.C., 15 December 1969

SPECTRUM ANALYZER (TEKTRONIX, INC. MODEL 491)

(6625-494-2937)

CONTENTS

Section 1	Characteristics
Section 2	Operating Instructions
Section 3	Circuit Description
Section 4	Maintenance
Section 5	Performance Check
Section 6	Calibration
	Abbreviations and Symbols
Section 7	Electrical Parts List
	Mechanical Parts List Information
Section 8	Mechanical Parts List
Section 9	Diagrams
	Mechanical Parts List Illustrations
	Accessories
APPENDIX A.	BASIC ISSUE ITEMS LIST
B.	MAINTENANCE ALLOCATION CHART
C.	REPAIR PARTS LIST

Abbreviations and symbols used in this manual  
are based on or taken directly from IEEE Stand-  
ard 260 "Standard Symbols for Units", MIL-  
STD-12B and other standards of the electronics  
industry.

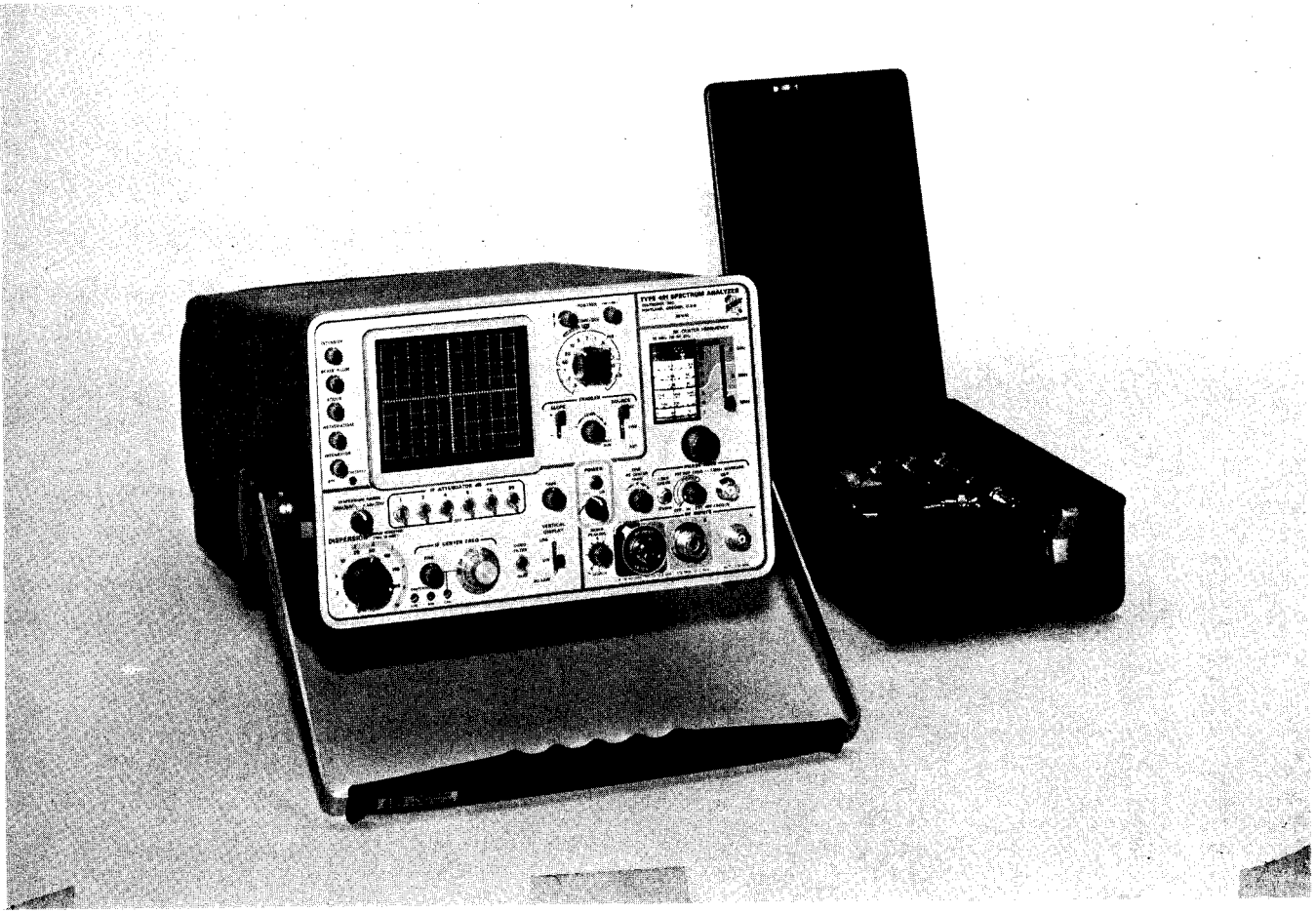

Fig. 1-1. The Type 491 Spectrum Analyzer.

# SECTION 1

## CHARACTERISTICS

The Type 491 Spectrum Analyzer is a wide band, general purpose portable spectrum analyzer with an RF center frequency range from 10 MHz to 40 GHz. The analyzer displays signal amplitude as a function of frequency for a selected portion of the spectrum. Frequency is displayed along the horizontal axis (dispersion) and signal amplitude on the vertical axis of a self-contained system.

The following electrical characteristics apply at an ambient temperature of 25° C (±5°C) after an initial warmup period of approximately 20 minutes.

### ELECTRICAL CHARACTERISTICS

Characteristic	Performance Requirement	Supplemental Information
RF Center Frequency Range	10 MHz to 40 GHz—See Table 1-1	
CW Sensitivity (S + N = 2N)	See Table 1-1	
Dial Accuracy	Within ± (2 MHz +1% of dial reading)	IF CENTER FREQ central at 000, FINE IF CENTER FREQ control and FINE RF CENTER FREQ controls centered.

**TABLE 1-1**

Minimum CW  
Sensitivity (S + N = 2N)

Band and Scale	RF CENTER FREQUENCY	1 kHz RESOLUTION	100 kHz RESOLUTION	Supplemental Information
A-1	10-275 MHz	-100 dBm	-80 dBm	50 Ω source impedance.  All voltages are RMS.
B-2	275-900 MHz	-110 dBm	-90 dBm	
3	800-2000 MHz	-105 dBm	-85 dBm	
C-4	1.5-4.0 GHz	-110 dBm	-90 dBm	
5	3.8-8.2 GHz	-100 dBm	-80 dBm	
6	8.0-2.4 GHz	-95 dBm	-75 dBm	
7	12.4-18.0 GHz	-90 dBm	-70 dBm	
8	18.0 -26,5 GHz	-80 dBm	-60 dBm	
	26.5-40.0 GHz	-70 dBm	-50 dBm	

**TABLE 1-2**

DISPERSION/DIV		Remarks
Setting	Accuracy	
10MHz	±3% (±0.3 MHz/Div)	Over the ±25 MHz of the IF Center FREQ control except the 10 MHz/DIV position (± 10 MHz). The DISPERSION CAL adjust can be reset to improve the accuracy at a specific IF CENTER FREQ control setting by using the front panel 1 MHz CAL MARKERS OUT as a calibrated signal.  Measured over the center 8 divisions of the graticule.
5 MHz	±3% (±0.15 MHz/Div)	
2 MHz	±5% (±0.1 MHz/Div)	
1 MHz	±7% (±70 kHz/Div)	
.5 MHz	±10% (±50 kHz/Div)	
.2 MHz	±15% (±30 kHz/Div)	

**ELECTRICAL CHARACTERISTICS** (cont)

Characteristic	Performance Requirement		Supplemental Information
Dispersion MHz/DIV RANGE			
Range	.2 MHz/Div to 10 MHz/Div		In a 1-2-5 sequence
Accuracy	See Table 1-2		
Linearity	±3% (over an 8 division display)		
kHz/DIV RANGE			
Range	1 kHz/Div to 500 kHz/Div in a 1-2-5 sequence and zero dispersion.		
Accuracy	±3% of each setting		Over the ±2.5 MHz range of the IF CENTER FREQ control. Measured over the center 8 divisions of the graticule.
Linearity	±3% (over an 8 divisions display)		
Resolution	≤1 kHz to ≥100 kHz; in 11 uncalibrated steps.		May be coupled with the DISPERSION control or switched separately.
IF Center Frequency Control Range*	IF CENTER FREQ	FINE	
1 kHz/DIV to 500 kHz/DIV Dispersion	≥(+ and - 2.5 MHz)	≥(+ and - 50 kHz)	
0.2 MHz/DIV to 5 MHz/DIV	≥(+ and - 25 MHz)	≥(+ and - 1 MHz)	
10 MHz/DIV	≥(+ and - 10 MHz)	≥(+ and - 1 MHz)	
IF Attenuation Range	0 to 51 dB		In combinations of 1, 2, 4, 8, 16 and 20 dB.
Accuracy	±0.1 dB/dB		
IF GAIN Control Range	≥50 dB		
Display Flatness with IF CENTER FREQ at 000	3 dB maximum amplitude variations from 10 MHz to 12.4 GHz. 6 dB maximum amplitude variations from 12.4 GHz to 40 GHz		Band 1 (10 MHz to 275 MHz) 50 MHz dispersion. Bands 2 through 8 (275 MHz to 40 GHz) 100 MHz dispersion.
Incidental FM IF	≤200 Hz		Typically 100 Hz. Up to 400 Hz if power line frequency drops to 48 Hz.
IF + LO	≤300 Hz (at LO fundamental and with phase lock operation)		
Phase Lock Internal Markers	1 MHz ±0.1% (Control next to OFF position.)		
INT REF FREQ Range	At least 1 kHz but not more than 1.3 kHz above measured frequency with the INT REF FREQ control counterclockwise (next to OFF position.)		Instrument must be inside the dust cover.
Stability; Ref. Osc. (Short term FM)	≤1 part in 10 <sup>7</sup> .		
External Phase Lock Reference Input Frequency	1 MHz to 5 MHz		
Voltage	1 to 5 volts peak to peak.		
Display Functions Dynamic Range			
LOG	≥40 dB with 8 division display		
LIN	≥26 dB with 8 division display		
SQ LAW	≥13 dB with 8 division display		
Maximum Input Power	-30 dBm for linear operation +15 dBm diode mixer, power limit		See Fig. 2-8

## TIME BASE

Characteristic	Performance Requirement	Supplemental Information
RECORDER Output	≥4 mV per displayed division amplitude of signal in LIN mode.	Rear panel connector
Sweep Range	10 μs/div to 0.5 s/div	In a 1, 2, 5 sequence
Sweep Accuracy	± 3 %	Measured within the center 8 divisions
VARIABLE Time/Div	≥2.5:1	An uncalibrated control provides continuously variable sweep rates from 10 μs/div to approximately 1.25 s/div.
Sweep Length	10.5 divisions ±0.2 div.	
Sawtooth Output	70 mV to 90 mV (P-P)	Rear panel connector

## TRIGGERING

Trigger Sensitivity Internal	≤0.2 division, 20 Hz to 100 kHz	
External	≤0.2 volt, 20 Hz to 100 kHz	
Maximum Input Voltage	100 volts (DC + peak AC)	

## POWER REQUIREMENTS

Input Voltage 115-volt range	LOW- 90 to 110 VAC MED- 104 to 126 VAC HIGH- 112 to 136 VAC	Line voltage ranges provide regulated DC voltages, when line contains less than 2% total harmonic distortion.
230-volt range	LOW- 180 to 220 VAC MED- 208 to 252 VAC HIGH- 224 to 272 VAC	
Line Frequency	48 to 440 Hz	
Input Power	55 watts maximum	

## CATHODE RAY TUBE

Characteristic	Information
Tube Type	T4910-7-1
Phosphor	P7
Accelerating Potential	Approximately 3.75 kV
Graticule Type	internal
Area	8 divisions vertical by 10 divisions horizontal Each division equals 0.8 cm.
Illumination	Variable edge lighting
Unblinking	Deflection type, DC coupled

## MECHANICAL CHARACTERISTICS

Construction	Alluminum-alloy chassis, panel and cabinet Glass laminate etched-circuit boards
Finish	Anodized panel, blue vinyl-coated cabinet
Overall Dimensions [measured at maximum points]	7¼" high, 12½" wide, 23½" long (includes panel cover and carrying handle)

## ENVIRONMENTAL CHARACTERISTICS

The following environmental test limits apply when tested in accordance with the recommended test procedure. This instrument will meet the electrical performance requirements given in this section, following an environmental test.

Characteristic	Performance Requirement	Supplemental Information
Temperature Operating	-15° C to +55° C	Automatic resetting thermal cutout protects instrument from overheating.
Non-operating	-55° C to +75° C	
Altitude Operating	15,000 feet maximum	Altitude referred to sea level. Operating temperature capabilities decline 10 C per 1000 feet altitude above sea level.
Non-operating	<b>50,000 feet maximum</b>	May be tested during non-operating temperature test.
Humidity Non-operating	Five cycles (120 hours) of Mil-Std-202C, Method 106B	Exclude freezing and vibration.
Electromagnetic Interference (EMI) Radiated Interference	150 kHz to 1000 MHz	Tested within an electrically shielded enclosure with the CRT mesh filter installed. Within the limits described in MIL-I-6181D, Figs. 7, 8, 14 and 16.
Conducted Interference	150 kHz to 25 MHz	Conducted interference through the power cord.
Vibration Operating	Resonant searches along all 3 axes at 0.025 inches, frequency varied from 10-55 c/s. All major resonances must be above 55 c/s.	Instrument secured to vibration platform during test. Total vibration time, about 55 minutes.
Shock Operating and non-operating	One shock of 30 G, one-half sine, 11 milli-second duration each direction along each major axis.	Guillotine-type shocks. Total of 12 shocks.
Transportation Package vibration	Meets National Safe Transient type of test when correctly packaged. One hour vibration slightly in excess of 1 G.	Package should just leave vibration surface
Package drop	30 inch (18-inches for R491) drop on any corner, edge or flat surface.	



# SECTION 2

## OPERATING INSTRUCTIONS

### Introduction

A Spectrum Analyzer is an instrument that graphically presents a plot of signal amplitude as a function of frequency for a selected portion of the spectrum. The Type 491 is designed to provide a spectral display of the frequency distribution of electromagnetic energy within the frequency range of 10 MHz to 40 GHz. Signals are displayed as a spectrum on a CRT screen with signal energy plotted on the vertical axis against frequency on the horizontal axis.

This type of display provides the following information: The presence or absence of signals, their frequencies, frequency drift, relative amplitude of the signals and the nature of modulation if any, plus many other characteristics.

This section of the manual describes the function of the front and rear panel controls and connectors, power supply connection, and a procedure for first time operation, to introduce the operator to the operational functions of the controls. The remainder of the section then describes operation technique with some measurement applications and signal interpretations.

### Front Cover and Handle

The front cover furnished with the Type 491 provides a dust tight seal around the front panel. Use the cover to protect the front panel when storing or transporting the instrument. The cover also provides storage for the external waveguide mixers and other accessories. See Fig. 2-1.

#### CAUTION

Removing or replacing the dust cover on the instrument may be hazardous, if the instrument is lifted out of, or slid into, the dust cover. To remove or replace the dust cover, set the instrument on a bench or table, then slide the cover off or on the instrument. The instrument may also be set on the front panel cover and the dust cover slipped on or off the instrument. Do not set the instrument on the front panel controls.

The handle of the Type 491 can be positioned to carry the instrument or it can be positioned at several angles to serve as a tilt-stand. To position the handle, press in at both pivot points (see Fig. 2-2) and adjust the handle to the desired position. The instrument may also be set upright on the rear panel feet for operation or storage.

### Voltage Considerations

The Type 491 can be operated from either 115 or 230-volt nominal line voltage with a range from 90 to 136 VAC or 180 to 272 VAC. Two selector-type connectors on the power input panel may be positioned to accommodate these voltage ranges. The selection assembly also includes two line

fuses which are positioned correctly when the correct selection is made for either 115 or 230-volt nominal operation. Fig. 2-3 shows the power input panel on the rear of the instrument and the voltage range and nominal line voltage selectors.

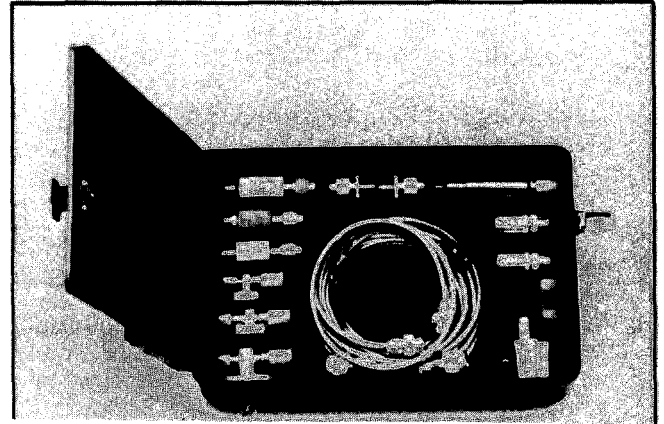

Fig. 2-1. Accessory storage provided in the front cover of the Type 491

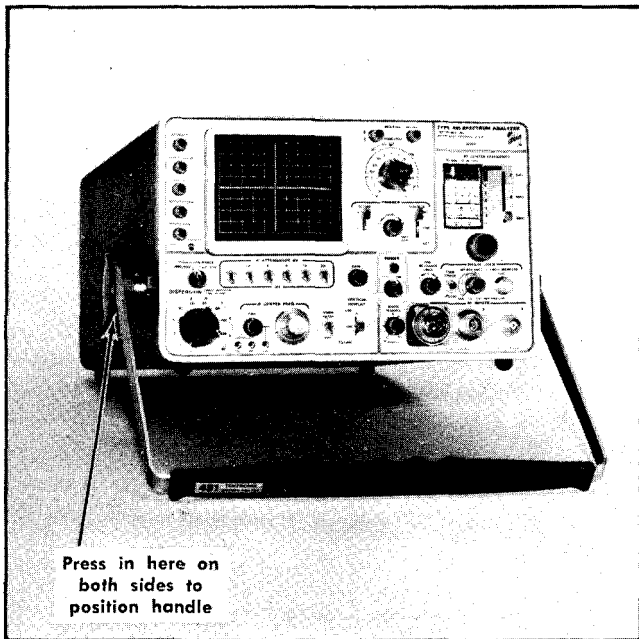

Fig. 2-2. Handle positioned to provide a stand for the instrument.

**CAUTION**

The Type 491 should not be operated with these voltage selector switches in improper positions. Operation of the instrument with incorrect voltages will either blow the protective fuses or the instrument will not operate properly.

The Voltage Range Selector located on the rear panel permits the instrument to operate on line voltages above and below the nominal 115 or 230 volts. Each selection provides correct regulation through an overlap voltage range into the next higher or lower range. It is best to select a range with its center voltage near your nominal line voltage, thus providing adequate regulation over a plus and minus deviation of the input line voltage.

The following procedure will prepare the instrument for operation at your average input line voltage:

1. Remove the cover assembly over the selectors by unscrewing the two cap screws, then pull the cover with the attached fuses away from the panel.
2. Pull the Line Voltage Selector out and turn the connector around to plug it back into the correct position.
3. To change the regulating range, pull out the Range Selector bar, slide it to the desired range and plug it into the correct position. Select a range which is centered about the average line voltage to be applied to the instrument. See Fig. 2-3.
4. Re-install the cover. Make certain the cover fits firmly against the rear panel, so the line fuses are seated in their sockets, and tighten the two cap screws.
5. Before applying power to the instrument, check that the indicating tabs on the switch bars are protruding through the correct holes for the desired voltage setup.

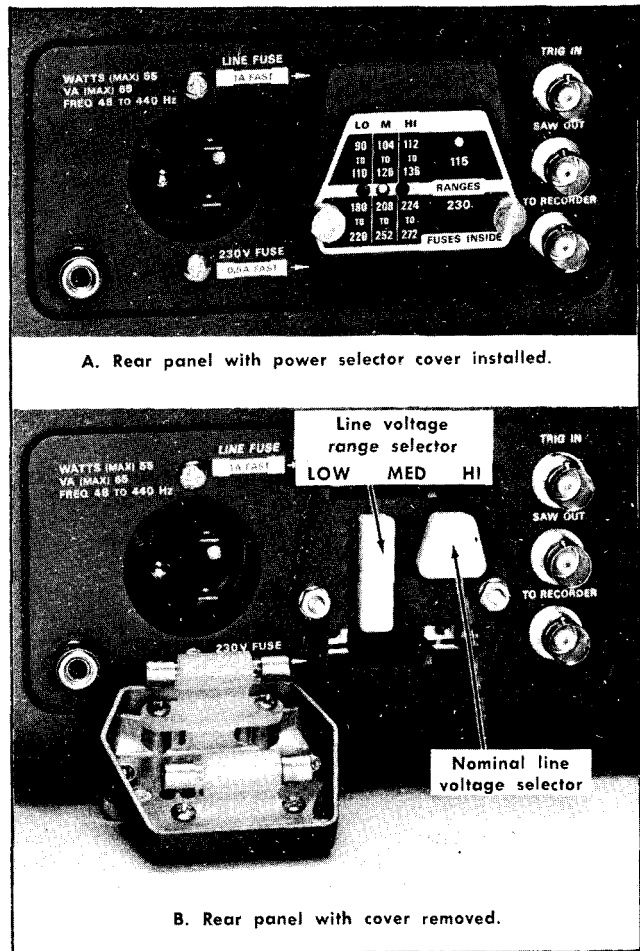

Fig. 2-3. Power panel and selectors.

**Spectrum Analyzer Terms**

The following glossary of spectrum analyzer terms is presented as an aid to understanding the terms as they are used in this manual.

**Spectrum Analyzer**-A device that displays a graph of the relative power distribution as a function of frequency, typically on a cathode-ray tube or chart recorder.

**Types:** Real-time and non real-time.

A real-time spectrum analyzer performs a continuous analysis of the incoming signal, with the time sequence of events preserved between input and output.

A non-real-time spectrum analyzer performs an analysis of repetitive events by a sampling process.

**Methods:** Swept front end and swept intermediate frequency.

A swept front end spectrum analyzer is a superheterodyne spectrum analyzer in which the first local oscillator is swept.

A swept IF spectrum analyzer is a superheterodyne spectrum analyzer in which a local oscillator other than the first is swept.

Center frequency (radio frequency or intermediate frequency)-That frequency which corresponds to the center of the reference coordinate.

Center frequency range (radio frequency)-That range of frequencies which can be displayed at the center of the reference coordinate. When referred to a control (e.g., Intermediate Frequency Center Frequency Range) the term indicates the amount of frequency change available with the control.

Dispersion (sweep width)-The frequency sweep excursion over the frequency axis of the display can be expressed as frequency/full frequency axis, or frequency (Hz)/division in a linear display.

Display flatness-Uniformity of amplitude over a rated dispersion. The maximum variation in amplitude response over the maximum dispersion is a measure of display flatness (usually in units of dB).

Drift (frequency drift)-Long term frequency changes or instabilities caused by a frequency change in the spectrum analyzer local oscillators. Drift limits the time interval that a spectrum analyzer can be used without retuning or resetting the front panel controls (units maybe Hz/s, Hz/°C, etc).

Dynamic range (on screen)-The maximum ratio of signal amplitudes that can be simultaneously observed within the graticule (usually in units of dB).

Dynamic range (maximum useful)-The ratio between the maximum input power and the spectrum analyzer sensitivity (usually in units of dB).

Frequency band-A range of frequencies that can be covered without switching.

Frequency scale-The range of frequencies that can be read on one line of the frequency indicating dial.

Incidental frequency modulation (residual frequency modulation)-Short term frequency jitter or undesired frequency deviation caused by instabilities in the spectrum analyzer local oscillators. Incidental frequency modulation limits the usable resolution and dispersion (in units of Hz).

Incremental linearity-A term used to describe local aberrations seen as non-linearities for narrow dispersions.

Linear display-A display in which the vertical deflection is a linear function of the input signal voltage.

Linearity (dispersion linearity)-Measure of the comparison of frequency across the dispersion to a straight line frequency change. Measured by displaying a quantity of equally spaced (in frequency) frequency markers across the dispersion and observing the positional deviation of the markers from an idealized sweep as measured against a linear graticule.

Linearity accuracy, expressed as a percentage, is within  $\frac{\Delta W}{W} \times 100\%$  where  $\Delta W$  is maximum positional deviation and  $W$  is the full graticule width.

Maximum input power-The upper level of input power that the spectrum analyzer can accommodate without degradation in performance (spurious responses and signal compression). [Usually in units of dBm].

Minimum usable dispersion-The narrowest dispersion obtainable for meaningful analysis. Defined as ten times the

incidental frequency modulation when limited by "incidental frequency modulation" (in units of Hz).

Phase Lock-The frequency synchronization of the local oscillator with a stable reference frequency.

Resolution-The ability of the spectrum analyzer to resolve and display adjacent signal frequencies. The measure of resolution is the frequency separation (in Hz) of two equal amplitude signals, the displays of which merge at the 3 dB down point. The resolution of a given display depends on three factors; sweep speed, dispersion and the bandwidth of the most selective (usually last IF) amplifier.

Resolution bandwidth-The -6 dB bandwidth (with Gaussian response) of the analyzer, with the dispersion and sweep time adjusted for the minimum displayed bandwidth of a CW signal. Resolution and resolution bandwidth become synonymous at very long sweep times,

Optimum resolution-The best resolution obtainable for a given dispersion and a given sweep time, Theoretically or mathematically:

$$\text{Optimum resolution} = \sqrt{\frac{\text{dispersion (in Hz)}}{\text{sweep time (in seconds)}}}$$

Optimum resolution bandwidth-The bandwidth at which best resolution is obtained for a given dispersion and sweep time. Theoretically and mathematically:

$$\text{Optimum resolution bandwidth} = 0.66 \sqrt{\frac{\text{dispersion (in Hz)}}{\text{sweep time (in seconds)}}}$$

Safe power level-The upper level of input power that the spectrum analyzer can accommodate without physical damage (usually in units of dBm).

Scanning velocity-Product of dispersion and sweep repetition rate (units of Hz/unit time).

Sensitivity-Rating factor of spectrum analyzer's ability to display signals.

1. Signal equals noise: That input signal level (usually in dBm) required to produce a display in which the signal level above the residual noise is equal to the residual noise level above the baseline. Expressed as: Signal + noise = twice noise.

2. Minimum discernible signal: That input signal level (usually in dBm) required to produce a display in which the signal is just visible within the noise.

Skirt selectivity-A measure of the resolution capability of the spectrum analyzer when displaying signals of unequal amplitude. A unit of measure (usually in Hz) is the bandwidth at some level below the 6 dB down points. For example: 10 dB, 20 dB or 40 dB down.

Spurious response (spuri, spur)-An erroneous display or signal which does not conform to the indicated frequency or dial reading. Spuri and spur are the colloquialisms used to mean spurious response (plural) or spurious response (singular) respectively. Spurious responses are of the following types.

1. IF feedthrough-Signal frequencies within the IF passband of the spectrum analyzer that are not converted in the first mixer but pass through the IF amplifier and produce dis-

plays on the CRT that are not tunable with the RF center frequency controls.

2. Image response-The superheterodyne process results in two major IF responses, separated from each other by twice the IF. The spectrum analyzer is usually calibrated to only one of these two responses. The other is called the image.

3. Harmonic conversion-The spectrum analyzer will respond to signals that mix with harmonics of the local oscillator and produce the intermediate frequency. Most spectrum analyzers have dials calibrated for some of these higher order conversions. The uncalibrated conversions are spurious responses.

4. Intermodulation-in the case of more than one input signal, the myriad of combinations of the sums and differences of these signals between themselves and their multiples creates extraneous response known as intermodulation. The most harmful intermodulation is third order, caused by the second harmonic of one signal combining with the fundamental of another.

5. Video detection-The first mixer will act as a video detector if sufficient input signal is applied, A narrow pulse may have sufficient energy at the intermediate frequency to show up as an intermediate frequency feedthrough.

6. Internal-A spurious response on the display caused by a signal generated within the spectrum analyzer that is in no way connected with an external signal.

7. Anomalous IF responses-The filter characteristic of the resolution-determining amplifier may exhibit extraneous passbands. This results in extraneous spectrum analyzer responses when a signal is being analyzed.

8. Zero frequency feedthrough-(zero pip)-The response produced when the first local oscillator frequency is within the IF passband. This corresponds to zero input frequency and is sometimes not suppressed so as to act as a zero frequency marker.

Sweep repetition rate-The number of sweep excursions per unit of time. Approximately the inverse of sweep time for a free-running sweep.

Sweep time-The time required for the spot on the reference coordinate (frequency in spectrum analyzer) to move across the graticule, (In a linear spectrum system, sweep time is Time/Division multiplied by total divisions.)

## CONTROLS AND CONNECTORS

The following is a brief description of the operation or function of the controls and connectors on the front (see Fig. 2-4) and rear panel, A more detailed description is given later in this section under operating information.

### CRT Controls

INTENSITY-Controls brightness of the CRT trace

SCALE ILLUM-Controls graticule light level.

FOCUS-Adjusts spot size for optimum display definition.

ASTIGMATISM-Used in conjunction with the FOCUS control to adjust spot shape and obtain optimum display definition.

INTENSIFIER-Controls the relative brightness between the displayed signal and the trace baseline.

POSITION-TWO (2) controls that position the CRT beam in the vertical and horizontal plane.

### Time Base Controls

TIME/DIV-Selects calibrated sweep rates from 0.5 s/div to 10  $\mu$ s/div in a 1-2-5 sequence.

VARIABLE-Permits an uncalibrated overlapping adjustment of the sweep rate so the sweep rate may be varied continuously from 10  $\mu$ s/div to approximately 1.25 s/div.

### Trigger Controls

SLOPE-Selects the positive or negative portion of the input signal to trigger the time base,

LEVEL-Selects the amplitude point on the triggering signal where sweep triggering occurs. In the fully clockwise position, the sweep circuit free runs.

SOURCE-Selects signal source for triggering the time base. Selections are: INT (from vertical amplifier); LINE (line voltage frequency); EXT (external signal applied to the rear panel BNC connector labeled TRIG IN).

### Spectrum Analyzer Section (IF)

DISPERSION RANGE-Selects the range of the DISPERSION selector.

DISPERSION—Selects the dispersion (frequency width) of the display in conjunction with the DISPERSION RANGE switch. Dispersion selections are 10 MHz/div to 1 kHz/div in a 1-2-5 sequence plus 0 dispersion position.

When the DISPERSION selector is in the 0 position, the analyzer functions as a fixed tuned receiver, permitting displays of the time domain characteristics of modulation within the resolution bandwidth capabilities of the analyzer.

COUPLED RESOLUTION-Selects the analyzer resolution bandwidth. Eleven selectable ranges from approximately 100 kHz to less than 1 kHz are provided. Optimum resolution for a given dispersion is generally obtained with the RESOLUTION control coupled to the DISPERSION selector. DISPERSION CAL—A screwdriver adjustment to calibrate the MHz/div dispersion.

DISPERSION BAL-Adjusted to balance the dispersion center (center frequency point) of the MHz/DIV and kHz/DIV positions of the DISPERSION RANGE switch.

IF ATTENUATOR dB-Series of six toggle switches to provide a range of IF attenuation from 1 dB to 51 dB.

GAIN-A variable control of the analyzer IF gain.

IF CENTER FREQ-A 10 turn control that adjusts the IF center frequency of the display. Provides a + and - 10 MHz adjustment in 10 MHz/DIV dispersion position, a + and - 25 MHz adjustment of the center frequency through the 5 MHz/div to 0.2 MHz/div positions and a + and - 2.5 MHz adjustments through the 500 kHz/div to 1 kHz/div DISPERSION positions.

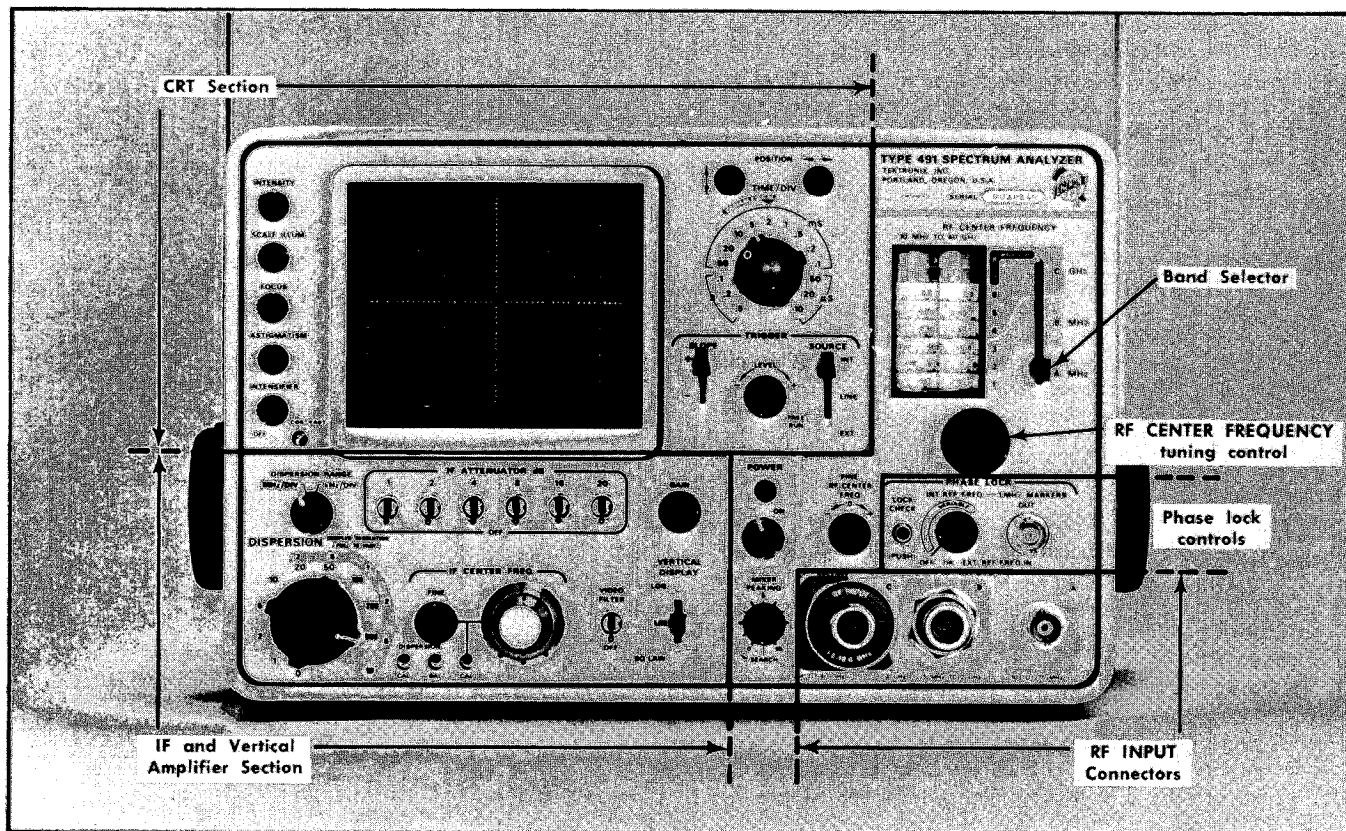

Fig. 2-4. Front panel controls and connectors.

FINE-A one turn control that operates in conjunction with the IF control to provide a fine adjustment of the IF center frequency.

CAL-With the IF CENTER FREQ control centered, it calibrates the IF center frequency to 200 MHz.

VIDEO FILTER-With the switch in the up position, the video bandwidth is restricted, to reduce high frequency video components such as noise, and reduce zero beats when viewing signals near minimum resolution.

VERTICAL DISPLAY-Selects logarithmic, linear or square-law display. In the LOG position, signal display amplitude is a logarithmic function with a  $\geq 40\text{-dB}$  dynamic range. In the LIN position, signal display amplitude is a linear function with a  $\geq 26\text{-dB}$  range. In the SQ LAW position signal display amplitude is a square law function and the display is a function of signal power, The SQ LAW position has a  $\geq 13\text{ dB}$  dynamic range.

POWER-Turns power off and on to the Type 491.

INDICATOR LIGHT-indicates when POWER is applied to the Type 491.

RF CENTER FREQUENCY-Tunes RF center frequency from 10 MHz to 40 GHz. With the IF CENTER FREQ control in the 0 position, the RF CENTER FREQUENCY dial indicates the center frequency of the display.

BAND SELECTOR-Switch selects RF Inputs and bands; A (10-275 MHz), B (270-2000 MHz) and C (1.5-40 GHz).

FINE RF CENTER FREQ-A 10 turn control to provide a fine adjustment of the RF local oscillator frequency. Especially useful in tuning the oscillator to a phase lock condition with the reference frequency.

MIXER PEAKING-A two position control that optimizes the conversion of the first local oscillator for bands B and C. Does not affect band A. In the SEARCH position the mixer current is swept through a range by the sweep voltage. This insures an optimum mixer conversion or sensitivity point within the dispersion range of the analyzer, so all signals within a given dispersion pass through this optimum sensitivity point as the signals are tuned across the screen. The manual (0 to 10) position of the control provides an adjustment to optimize mixer conversion for any fixed center frequency setting.

LOCK CHECK-A push button switch that applies the phase lock output beat signal (between the local oscillator and reference frequency) to the vertical display system. Provides a visual indication to the operator of phase lock operation.

INT REF FREQ-A switch and control. The control varies the internal 1 MHz Reference Frequency over a range of approximately 1 kHz. With the control in the OFF position, the Internal Reference Frequency is turned off, and an externally applied signal to the EXT REF FREQ IN (1 MHz MARKERS OUT) connector becomes the reference frequency.

1 MHz MARKERS OUT-EXT REF FREQ IN-A BNC connector that provides 1 MHz marker output signals to calibrate the dispersion. With the INT REF FREQ control in the OFF position, an external signal between 1 MHz and 5 MHz (1 to 5 V peak to peak) applied to the connector becomes the reference frequency for phase lock operation.

RF INPUTS-Coaxial connectors which connect through either a coaxial cable, or (if above 12.4 GHz) a waveguide mixer, to the signal source. Band A frequency range is 10 to 275 MHz. Band B frequency range is 275 MHz to 2 GHz. Band C consists of a coaxial mixer (green label) for the frequency range 1.5 GHz to 12.4 GHz; or a Waveguide Mixer Adapter (black label) which connects through a two foot cable to one of three external Waveguide Mixers for the frequency range 12.4 GHz to 40 GHz.

### Rear Panel

TRIG IN-A BNC connector to apply external triggering signals. Frequency range: 20 Hz to 100 kHz, signal amplitude equal to or greater than 0.2 V.

SAW OUT-A 70 to 90 mV sawtooth signal output that is coincident with the analyzer sweep.

RECORDER-Signals on the display may be recorded by connecting to the RECORDER output. A linear output, equal to or greater than 4 mV per displayed division amplitude of signal, in the LIN mode, into a load impedance of 600 ohms.

## FIRST TIME OPERATION

The following procedure demonstrates the basic functions of the controls and connectors for the Type 491. We recommend this procedure for first time familiarization. Careless or incorrect operation may damage the instrument.

1. Check input power selector positions at the rear panel. Correct selector positions for the different input line voltages are given under Voltage Considerations in this section.

2. Preset the front panel controls as follows:

POWER OFF

### CRT Controls

INTENSITY CCW  
 SCALE ILLUM Midrange  
 FOCUS Midrange  
 ASTIGMATISM Midrange  
 INTENSIFIER CCW  
 POSITION Midrange  
 (Both centrals)

### Time Base Controls

TIME/DIV 10ms  
 VARIABLE CAL  
 SLOPE +  
 LEVEL FREE RUN  
 SOURCE INT

### Analyzer Controls

DISPERSION RANGE MHz/DIV  
 DISPERSION—COUPLED Controls coupled together  
 RESOLUTION and in the 10 MHz/div  
 position  
 IF ATTENUATOR dB All switches OFF position  
 IF CENTER FREQ Centered (000)  
 FINE Midrange  
 VIDEO FILTER OFF  
 VERTICAL DISPLAY LIN  
 GAIN CCW  
 RF CENTER FREQUENCY Band B  
 FINE RF CENTER FREQ Centered (approximately  
 5 full turns from either  
 extreme position)  
 INT REF FREQ Out of the OFF switch  
 detent in the VARIABLE  
 position  
 MIXER PEAKING Fully CCW in the  
 switched SEARCH position

3. Connect the Type 491 to a suitable power source and turn the POWER switch to ON. Allow a few minutes for the instrument to stabilize.

4. Adjust the INTENSITY control clockwise until a trace is visible, then adjust the FOCUS and ASTIGMATISM controls for optimum trace definition.

5. Position the trace to the horizontal center and to the bottom graticule line of the graticule with the POSITION controls.

6. Adjust SCALE ILLUM control for the desired graticule illumination.

7. Apply a signal with an amplitude between -60 and -30 dBm, from a Signal Generator or other source that is, within the frequency range of band B, through a coaxial cable to band B, RF INPUT connector.

### NOTE

If a signal source within the frequency range of band B is not available, apply the signal to band A or C and set the band selector to the appropriate band.

8. Adjust the GAIN control for a moderate noise level (1 division) on the display, then tune the RF CENTER FREQUENCY control through the frequency range. Note that some of the signals move across the screen at different rates, and the direction of movement (left to right or right to left) of the signals is not the same. (See Spurious and Image Frequency displays later in this section.)

9. Tune the dial with the RF CENTER FREQUENCY control to the frequency of the applied input RF signal.

10. Switch the MIXER PEAKING control from SEARCH position to manual, then adjust for optimum signal amplitudes.

11. Adjust the GAIN and/or the IF ATTENUATOR dB switches for a signal amplitude of approximately 6 divisions.

## GENERAL OPERATING INFORMATION

### Light Filters

The instrument is shipped with a mesh filter installed. Two (2) colored filters, plus a clear CRT faceplate protector and an ornamental ring are provided with the accessories. The mesh filter improves the contrast when viewing the display under high ambient light conditions. The blue and yellow filters can be used to take advantage of the dual phosphor characteristics of the P7 CRT.

The mesh filter is removed by pressing down at the bottom of the frame and pulling the top of the holder away from the CRT faceplate. See Fig. 2-5. To install the colored filters, press them into the ornamental mounting ring until they snap behind the retainer lips. To remove the filters from their holder, press them out to the rear.

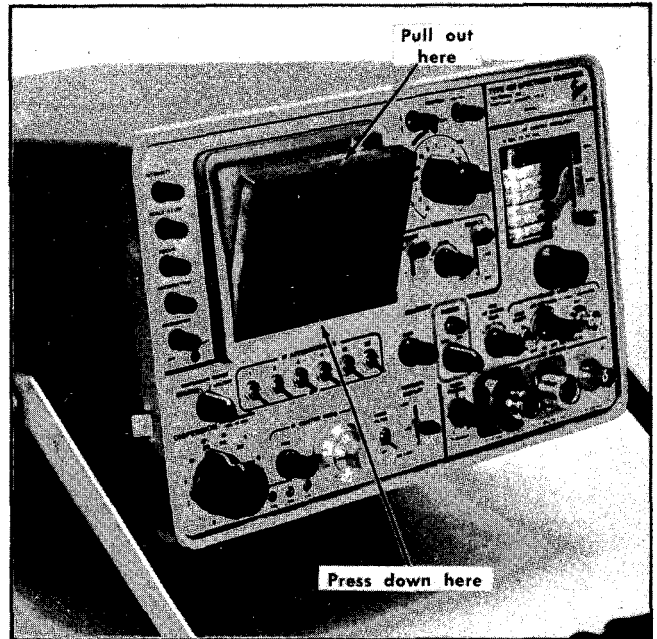

Fig. 2-5. Removing the light filter or faceplate.

One of the filters or protector should be used at all times to protect the faceplate of the CRT from scratches.

### Intensity Level, Astigmatism and Focus

Operate the instrument with the intensity level no higher than the level required to clearly observe the display. Changing the INTENSITY setting may require refocusing the display.

The ASTIGMATISM and FOCUS controls both affect display definition and are normally adjusted together. If the ASTIGMATISM control is correctly set, the vertical and horizontal segments of the display will focus at the same position of the FOCUS control. The controls are adjusted as follows:

1. Obtain a display on the analyzer with both horizontal and vertical information.
2. Adjust the ASTIGMATISM control for equally focused vertical and horizontal portions in the display.

12. Tune the signal to the extreme left graticule line with the RF CENTER FREQUENCY control. Note the dial reading. Tune the signal to the extreme right graticule line and note the dial reading. The difference between dial readings is the total dispersion window for this 10 division display. Tune the signal to the center of the screen and switch the DISPERSION-COUPLED RESOLUTION selector to the 5 MHz/div position. Tune the signal across the screen and note the total dispersion. It should decrease to approximately  $\frac{1}{2}$  the dispersion noted with the DISPERSION selector in the 10 MHz/div position. Tune the signal to the center of the screen.

13. Tune the IF CENTER FREQ coarse control through its range. Note that all signals move across the screen in the same direction and the same amount. This control shifts the IF center frequency approximately + and - 25 MHz with the DISPERSION controls in this position. Tune the IF CENTER FREQ control to center the signal on the screen.

14. Change the DISPERSION selector to .5 MHz/div. Adjust the FINE (1 turn) IF CENTER FREQ control. Note the frequency range of this control. This control shifts the IF center frequency approximately + and - 1 MHz with the DISPERSION RANGE in this position.

15. Change the TIME/DIV switch between .1 s and .1 ms positions. Note the change in signal amplitude and the resolution. Return the TIME/DIV selector to the 10 ms position.

16. Push the LOCK CHECK button and tune the RF CENTER FREQUENCY control very carefully through the signal frequency. Note the phase lock beat signals between the tunable local oscillator and the Internal Reference Frequency oscillator as the display blooms, then snaps into phase lock operation (Fig. 2-13).

17. With the LOCK CHECK button depressed, adjust the FINE RF CENTER FREQ control. Note the beat frequency displays as the control is varied, and note also the vertical shift of the baseline. This baseline shift is the change in the output DC level of the phase amplifier. Note the zero beat signal compression at the extreme positions of this control compared to their amplitude near the center. Phase lock should be set with the output DC level within the center 4 divisions of the graticule. Adjust for phase lock operation and release the LOCK CHECK button.

18. Switch the DISPERSION RANGE switch to kHz/DIV, then decrease the DISPERSION TO 20 kHz/div, keeping the signal centered on screen with the IF CENTER FREQ control. Slowly rotate the FINE RF CENTER FREQ control. Note the positive action of the phase lock circuit before lock is lost. Return the signal to its locked mode by adjusting the FINE RF CENTER FREQ control.

19. Uncouple the RESOLUTION and turn the control clockwise. Note that the signal broadens as the resolution bandwidth is increased. The resolution may be varied from approximately 1 kHz to 100 kHz. Return the RESOLUTION control to the coupled position.

20. Adjust the INTENSIFIER control through its range. This control suppresses the base of the display, and can be utilized when photographing displays at slow sweep rates. See Operation of the INTENSIFIER control. It should be left in the OFF position for most operating situations.

3. Adjust the FOCUS control for optimum focus of the vertical sections of the display.

4. Repeat the two adjustments for best overall focus and display definition.

### Trace Alignment

If a free running trace is not parallel to the horizontal graticule lines, the trace may be aligned by means of an internal Trace Rotation adjustment. Refer to the Calibration section.

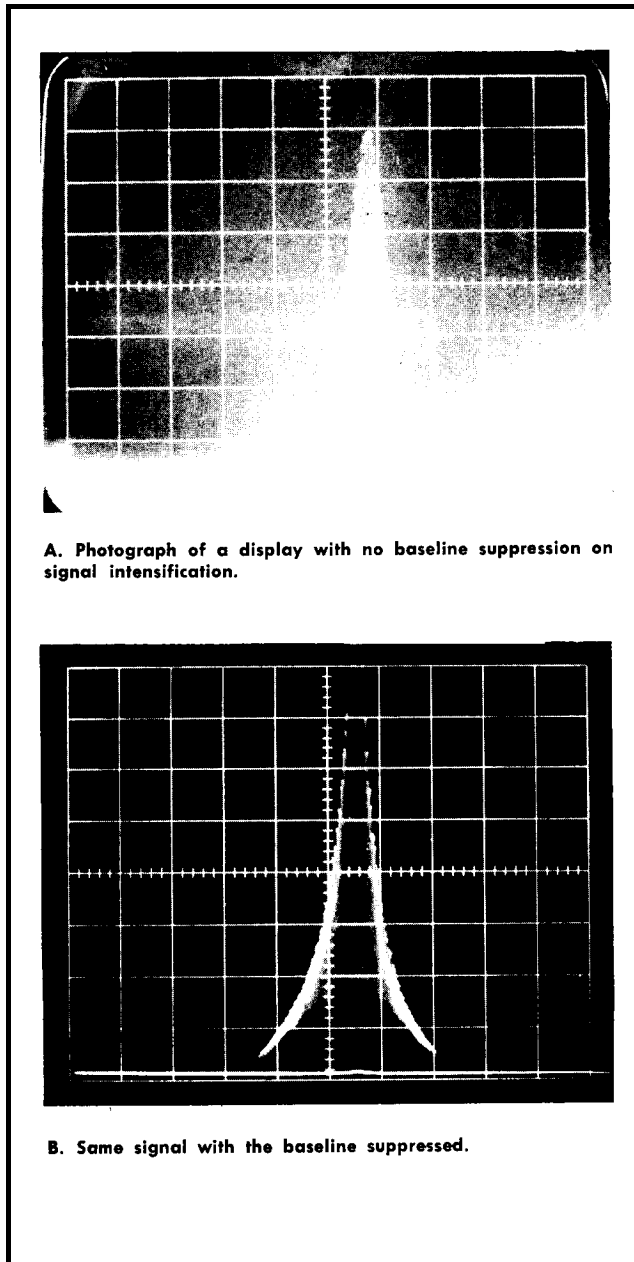

Fig. 2-6. INTENSIFIER operation.

### Operation of the INTENSIFIER and CONTRAST Controls

These controls are used to suppress the brightness of the display baseline when large variations in display brightness are not desirable; for example, when photographing or viewing displays at very slow sweep rates. The INTENSIFIER adjusts the height of the suppressed baseline. The CONTRAST adjusts the degree of contrast between the suppressed portion and the intensified portion of the display.

The adjustment of the CONTRAST is optional; however, it is normally set to produce a suppressed portion that is still visible, so the intensity level of the vertical and horizontal portions of the display are equalized at slow sweep rates.

The INTENSIFIER control is normally operated in the OFF position, so the display and baseline are intensified. It is turned on to suppress the baseline at slow sweep rates, in preparation for display photography. See Fig. 2-6.

### Signal Application

The application of any RF signal to the Type 491 is determined by its frequency and level. Signals between 10 MHz and 275 MHz are applied to the Band A, BNC connector. Frequencies from 275 MHz to 2 GHz are applied to the band B, N-type connector, and band C covers the remaining frequency range from 1.5 GHz to 40 GHz. Signals should be applied through the standard cables supplied with the accessories. Cables such as RG 9B/U will give satisfactory performance to approximately 12.4 GHz. Signals in the 12.4 GHz to 40 GHz range are applied to external Waveguide Mixers which connect through a two-foot coaxial cable and a Waveguide Mixer Adapter to the input receptacle. The Waveguide Mixer Adapter replaces the Coaxial Mixer Assembly in the input receptacle.

The selection of mixers and adapters for the frequency coverage is as follows:

1.5 GHz to 12.4 GHz-Plug-in Coaxial Mixer, Tektronix Part No. 119-0096-00.

12.4 GHz to 40 GHz-Waveguide Mixer Adapter, Tektronix Part No. 119-01 04-00; Coaxial Cable, Tektronix Part No. 012-0115-00 and one of the following Waveguide Mixers.

Waveguide Band designation	( EIA designation)	Frequency Range	Flange Type	Tektronix Part Number
Ku	WR62	12.4 GHz to 18.0 GHz	UG-419/U	119-0097-00
K	WR42	18.0 GHz to 26.5 GHz	UG-595/U	119-0098-00
Ka	WR28	18.0 GHz to 40.0 GHz	UG-599/U	119-0099-00



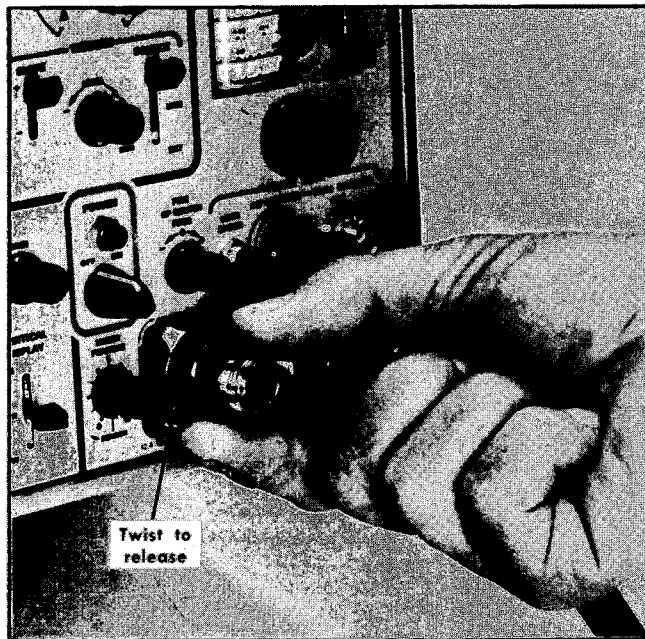

Fig. 2-7. Changing band C Coaxial Mixer to Wave Guide Adapter,

The Mixer Adapter or Coaxial Mixer may be removed from the input receptacle by turning the retainer ring in either direction. See Fig. 2-7. To replace either assembly, push the adapter or coaxial mixer against the spring until the flange bottoms, then turn until the latch snaps to hold the unit in place.

Signal input power to the analyzer should not exceed -30 dBm. Signal above this level will overload the 1st mixer and/or the 1st IF stage and generate spurious signals on the display. Add at least 10 dB of attenuation to the input when the signal begins to compress (no increase of signal amplitude with an increase of signal level). A conversion chart (Fig. 2-8) may be used to calculate input signal level.

#### CAUTION

Signals stronger than +15 dBm applied to the input or mixer will damage or burn out the mixer diodes.

Mismatches between the signal source and the RF INPUT connectors may be caused by signal source output impedance, long coaxial cables, etc. These mismatches will adversely affect display flatness. When optimum flatness is desired and signal strength is adequate, a 50  $\Omega$  attenuator pad of approximately 6 to 10 dB should be added between the signal source and the input to the mixer. The addition of the attenuator will minimize reflections and optimize display flatness.

Three attenuator pads, 10 dB, 20 dB and 40 dB are supplied with the accessories kit. These three attenuators may be stacked on the N type connector to provide up to 70 dB attenuation. A support should be provided however, if more than 2 attenuators and an N to BNC adapter are stacked on the band A connector. The attenuators are rated at 2 watts (average).

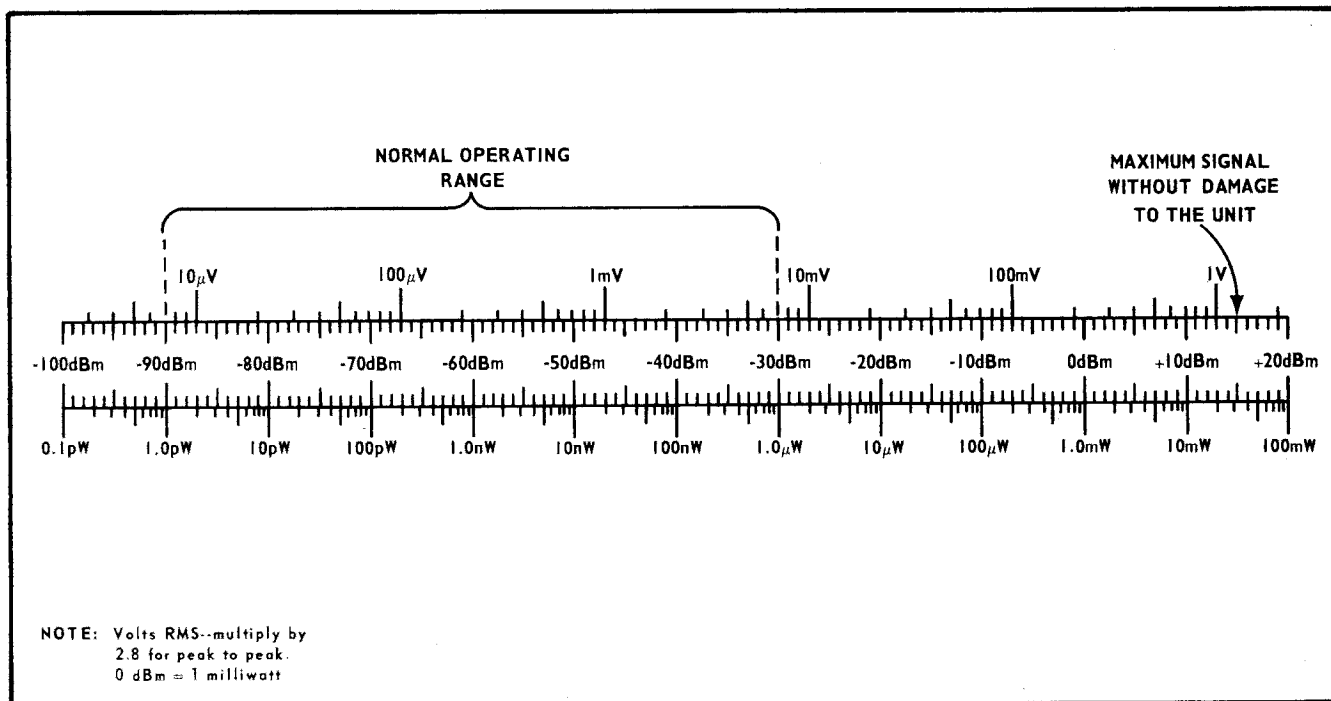

Fig. 2-8. Volts-dBm-Watts conversion chart for 50  $\Omega$  impedance.

## Mixer Peaking

The MIXER PEAKING control has a switch and variable control position and is used to optimize mixer conversion in the harmonic bands of Band C. The switched position (fully ccw) is referred to as the SEARCH mode. In this position, an optimum mixer conversion or sensitivity point is provided within the dispersion window so signals that are tuned across the screen will pass through this optimum sensitivity point. This insures that most signals within a given dispersion window will be observed as the RF CENTER FREQUENCY control is tuned.

Mixer conversion becomes a manual adjustment with the control in the VARIABLE position and should be optimized at each RF CENTER FREQUENCY setting. It has no affect on band A and is usually broad through the B and C band frequency range.

Relative amplitude and sensitivity measurements must be made after the MIXER PEAKING is adjusted because the display response is not flat when the central is in the SEACH position.

## Dispersion

Dispersion is the swept frequency range, or screen window. The dispersion is adjustable from 10 MHz/div to 1 kHz/div in a 1, 2, 5 sequence with an added zero dispersion position for fixed frequency operation. Band A is limited to a maximum usable dispersion of 5 MHz/div ( $\pm 25$  MHz), because of the added 235 MHz low pass filter.

Dispersion accuracy is a function of the IF CENTER FREQ control position and the DISPERSION RANGE switch setting. See Characteristics section. The dispersion accuracy far the kHz/div selections is greater than the MHz/div selections, because the range of the IF CENTER FREQ is ten times greater for the MHz/div ranges ( $\pm 25$  MHz in the MHz/DIV range).

The front panel DISPERSION-CAL adjustment may be used to recalibrate dispersion for specific IF CENTER FREQ control settings if a high degree of accuracy is desired. The procedure is described in step 4 for front panel calibration.

## Resolution

Resolution is the ability of the spectrum analyzer to display adjacent signal frequencies discretely. The measure of resolution is the frequency separation (in Hz) of two equal amplitude signals when the notch or dip between these signals is 3 dB down. The resolution for a given display is a function of sweep speed, dispersion and bandwidth of the most selective (usually the last IF) amplifier in the signal path.

Resolution bandwidth is approximately the -6 dB bandwidth (with Gaussian response) of the analyzer, with the dispersion and sweep time adjusted for the minimum displayed bandwidth to a CW signal. Resolution and resolution bandwidth become synonymous at very long sweep times.

As the analyzer sweep rate is increased, the amplitude of the CW signal will decrease and the bandwidth becomes wider; which signifies that both the sensitivity and resolution have been degraded by the analyzer sweep rate.

As the analyzer sweep rate is increased, the amplitude of the CW signal will decrease and the bandwidth becomes wider; which signifies that both the sensitivity and resolution have been degraded by the analyzer sweep rate,

The loss of the analyzer sensitivity due to sweep rate and dispersion can be expressed mathematically as:

where  $S/S_0$  is the ratio of the effective sensitivity to the analyzer measured sensitivity, at very slow sweep rates or zero dispersion.

D is the dispersion in hertz

B is the -3 dB bandwidth of the analyzer in hertz

T is the sweep time in seconds, or  $\frac{T}{D}$  is the sweep rate.

These same variables also determine the resolution of the analyzer. The loss in resolution can be expressed as follows:

Where  $R/R_0$  is the ratio of the effective resolution of the analyzer to the analyzer measured resolution bandwidth at very slow sweep speeds.  $R_0$  is somewhat arbitrary and is taken as the displayed width of the CW signal at the -6 dB point.

The resolution of the Type 491 Spectrum Analyzer is optimized for most settings of the DISPERSION selector when the RESOLUTION control is in the coupled position. Resolution however, can be varied from approximately 100 kHz to less than 1 kHz by uncoupling the RESOLUTION control and changing it as an independent function of the DISPERSION selector.

The sweep rate, as previously mentioned, should be set below the sweep rate at which there is no noticeable amplitude loss in the signal.

As previously shown in the above formula the effective resolution of the analyzer is a function af the IF bandwidth. To adequately resolve pulsed spectrum information, the resolution bandwidth of the analyzer should be on the order of 1/10 of the sidelobe frequency width or the reciprocal of the pulse width. The RESOLUTION control is usually set, after the sweep rate has been adjusted, for optimum main lobe detail. See Fig. 2-9.

## Front Panel Calibration Adjustments

Three front panel screwdriver adjustments are provided, to enable the operator to calibrate the dispersion and IF CENTER FREQ controls, and balance the MHz and kHz positions of the DISPERSION RANGE selector.

### 1. Balance and Calibration Check

a. Turn the INT REF FREQ control to OFF position, then tune a signal on screen with the RF CENTER FREQUENCY control.

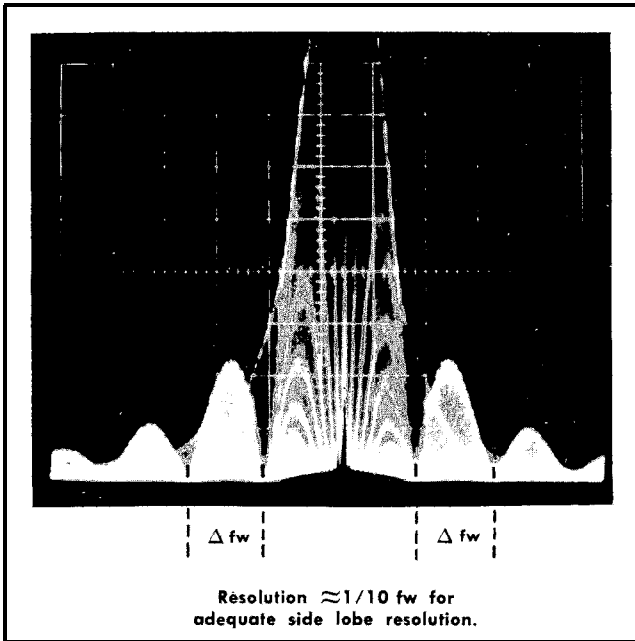

Fig. 2-9. Frequency spectrum of a pulsed cw signal.

b. Tune for minimum signal shift as the DISPERSION RANGE is switched from MHz/DIV to kHz/DIV positions.

c. With the DISPERSION RANGE selector at MHz/DIV position, adjust the IF CENTER FREQ control for minimum signal shift as the DISPERSION control is switched through the 10 to .2 MHz positions.

d. Center the signal with the Horizontal POSITION control and check the position of the signal on the sweep. The signal should locate near the center of the sweep with the sweep extending over the 10 division width of the graticule.

If calibration is required, proceed with the following adjustments.

#### NOTE

These adjustments interact, and must be performed in sequence.

## 2. IF CENTER FREQ-CAL Adjustment

a. Center the IF CENTER FREQ controls, the DISPERSION BAL and the IF CENTER FREQ-CAL adjustments. Set the DISPERSION RANGE to MHz/DIV and the DISPERSION selector to 5 MHz/div position.

b. Apply a stable RF signal to the appropriate RF INPUT connector; then tune to the signal frequency with the RF CENTER FREQUENCY control. Adjust the GAIN control for a signal amplitude of approximately 6 divisions.

c. Adjust the RF CENTER FREQUENCY and the FINE RF CENTER FREQ controls for minimum signal shift as the DISPERSION RANGE is switched between the MHz/DIV and the kHz/DIV position.

d. With the DISPERSION RANGE in the MHz/DIV position, adjust the IF CENTER FREQ-CAL for minimum signal shift as the DISPERSION is switched through the MHz (10 MHz - .2 MHz) positions.

e. Return the DISPERSION to the 5 MHz/div position. Position the signal to the graticule center with the Horizontal POSITION control. If the signal is more than 1 division from the sweep center, it will be necessary to adjust the internal Sweep Center adjustment R203. See Calibration section.

## 3. DISPERSION-BAL Adjustment

a. Preset the front panel controls as follows:

IF CENTER FREQ and FINE	000 (centered)
DISPERSION RANGE	MHz/DIV
DISPERSION	5 MHz/div

b. Tune the RF signal to the screen center.

c. Adjust the DISPERSION BAL for minimum signal shift as the DISPERSION RANGE switch is switched between the MHz/DIV and kHz/DIV positions. (Start the balance adjustment with the DISPERSION selector in the 5 MHz position, then decrease the dispersion to the .2 MHz-20 kHz position for the final adjustment.)

#### NOTE

If the dispersion balance can not be achieved with the above procedure, the instrument requires internal adjustment. Refer to the Calibration section of the manual.

## 4. DISPERSION-CAL Adjustment

a. Preset the front panel controls as follows:

IF CENTER FREQ	000 (centered)
DISPERSION RANGE	MHz/DIV
DISPERSION	1 MHz/div
VERTICAL DISPLAY	SQ LAW
RF Input Selector	Band B
INT REF FREQ	Just out of the OFF detent

b. Connect the 1 MHz MARKERS OUT signal through a coaxial cable to the band B RF INPUT connector.

c. Tune the RF CENTER FREQUENCY control to align the tunable markers to the fixed marker signals.

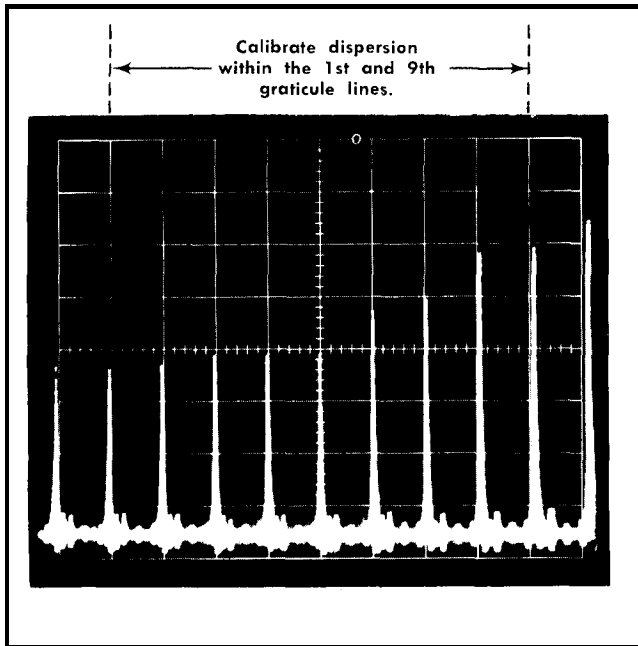

Fig. 2-10. 1 MHz MARKERS OUT (Phase lock reference) connector. DISPERSION 1 MHz/div.

d. Adjust the DISPERSION-CAL for 1 marker/division. Use the Horizontal POSITION control or the IF CENTER FREQ control to align the markers to the graticule lines. Dispersion is calibrated over the center 8 divisions of the display. See Fig. 2-10.

### Video Filter Operation

The video filter restricts the video bandwidth so that noise or beat signals are reduced. This application is very useful when analyzing signals close to minimum resolution bandwidth. Fig. 2-11 shows the apparent increased resolution when the VIDEO FILTER is turned on. It does restrict the useable sweep rate, because of the filter time constant, to about 50 ms/div or slower.

### Vertical Display Modes

The appearance of the displayed signal depends to a great extent on the setting of the VERTICAL DISPLAY switch. For example; to accentuate the side lobes of a signal, the LOG (40 dB full screen) position should be used, as compared to the SQ LAW (13 dB full screen) position. Fig. 2-12 illustrates the effect of each display mode or each position of the VERTICAL DISPLAY switch.

The LOG position increases the dynamic range of the display by attenuating large amplitude signals more than small amplitude signals. This produces a display which approximates a logarithmic response curve. The circuit is basically a compression circuit, and is most effective when there are large signal amplitude differences.

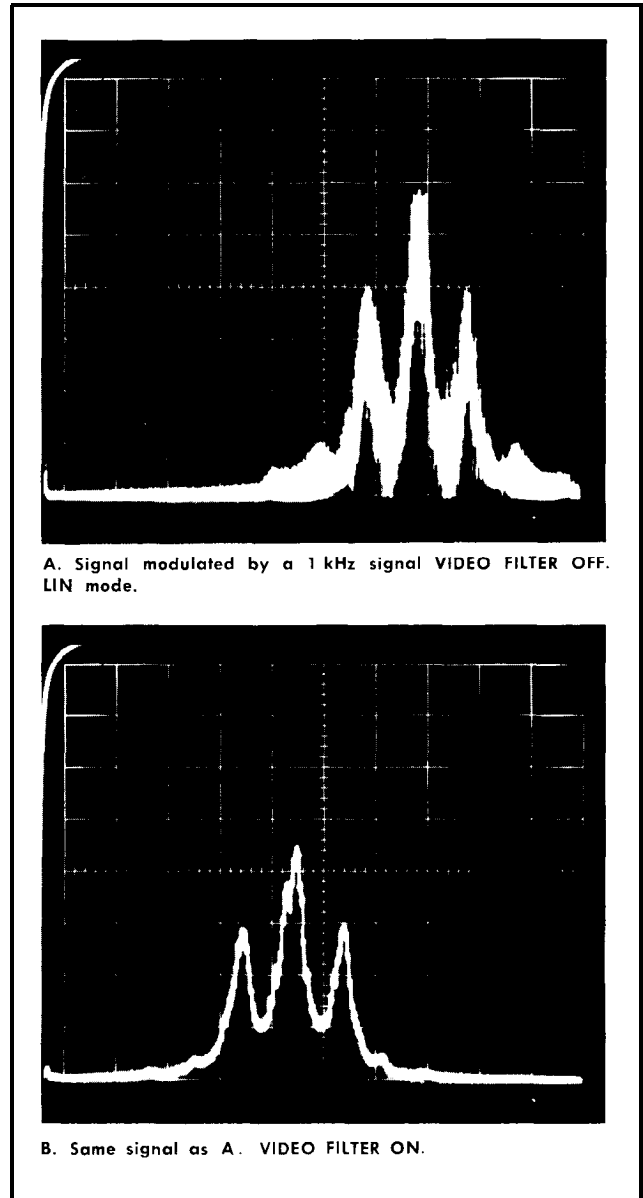

A. Signal modulated by a 1 kHz signal VIDEO FILTER OFF. LIN mode.

B. Same signal as A. VIDEO FILTER ON.

Fig. 2-11. Integrating the display with the video filter.

The SQ LAW (power) position provides a display that is approximately proportional to the square of the input signal amplitude. The display, therefore, approximates the input signal power. This is basically an expansion circuit to accentuate small amplitude differences.

### Selecting the Sweep Rate

The sweep rate for wide dispersion coupled resolution settings is usually set just above the visual flicker setting; however, as the DISPERSION is decreased the sweep rate will begin to affect the resolution and sensitivity of the analyzer, as described under Obtaining Optimum Resolution. Therefore, as the DISPERSION settings are reduced the sweep rate should also be reduced to maintain sensitivity and resolution.

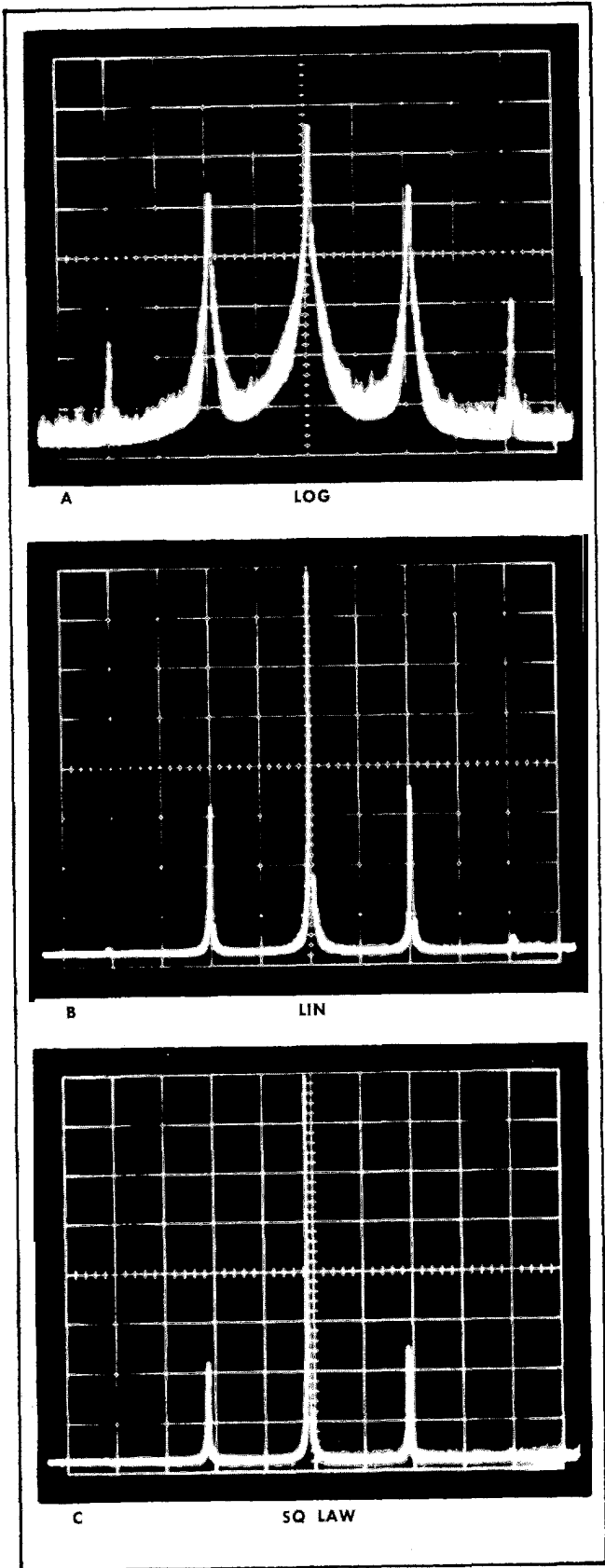

Fig. 2-12. VERTICAL DISPLAY Modes showing a 100 MHz carrier signal modulated by 20 kHz.

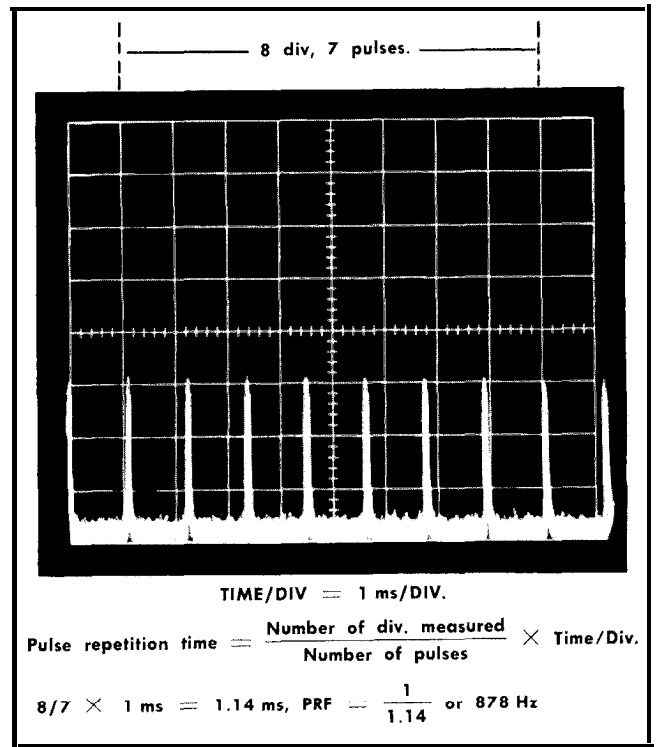

Fig. 2-13. Measuring timing between pulses.

With the DISPERSION control set to 0, the analyzer functions as a fixed tuned receiver. The analyzer therefore displays time domain characteristics of the signal modulation within the bandwidth capabilities of the analyzer.

Timing information such as pulse repetition rate may be obtained by triggering the sweep on the INT signal source and switching the TIME/DIV control to a calibrated sweep rate that will permit measurement in time between the modulation pulses. See Fig. 2-13.

### Triggering the Sweep

For most applications the trigger LEVEL control is switched to the FREE RUN position and the sweep repetition rate is a function of the TIME/DIV selector settings.

In some applications, particularly at 0 dispersion, or when slaving the Type 491 to a recorder, it may be desirable or necessary to trigger the display. The Type 491 may be triggered from the following three sources: INT, LINE and EXT.

When the SOURCE switch is in the INT position, the display is triggered on the video display. The Type 491 requires approximately 0.2 division of signal amplitude for internal triggering. If the sweep will not trigger on INT when the LEVEL control is adjusted, it may be necessary to tune

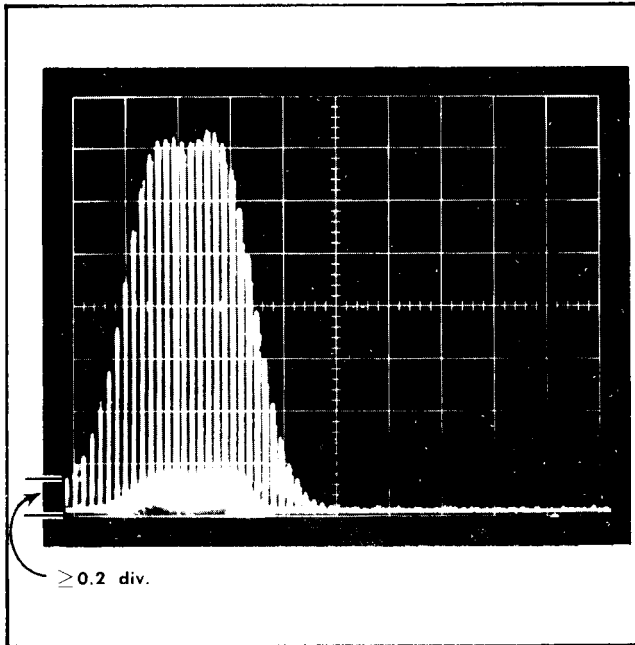

Fig. 2-14. To trigger the analyzer from the display requires 0.2 divisions of signal. Tune the spectrum null point away from the sweep starting point, with the RF CENTER FREQUENCY control.

the FINE RF or IF CENTER FREQ control to move the sweep start off a spectrum null point. See Fig. 2-14.

When the SOURCE switch is in the LINE position, the display is triggered from a sample of the power input line frequency. This feature provides a stable display when the signal is time-related to the line frequency.

External triggering requires a signal equal to or greater than 0.2 V, within the frequency range of 20 Hz to 100 kHz, to trigger the sweep. The signal is applied to the TRIG IN connector on the rear panel. External triggering will provide a stable display when the internal signal triggering is unstable. It may also be used to slave the analyzer to a recording device.

The SLOPE switch selects the positive or negative-going portion of the triggering signal. The LEVEL control selects the required signal amplitude to trigger the sweep for single sweep operation.

### RF Center Frequency Tuning

The dial and the analyzer are tuned through the frequency range of each band by the RF CENTER FREQUENCY control. The dial frequency calibration is accurate to within  $\pm (2 \text{ MHz} + 1\% \text{ of the dial reading})$  when the FINE RF CENTER FREQ and the IF CENTER FREQ controls are centered.

The RF CENTER FREQUENCY control is supplemented by a FINE RF CENTER FREQ, ten turn control, that provides a fine tuning adjustment through a limited frequency range on either side of the dial frequency, or the RF center frequency. This allows fine tuning when operating on the high frequency scales with narrow dispersion, or fine adjustment to establish a phase lock condition.

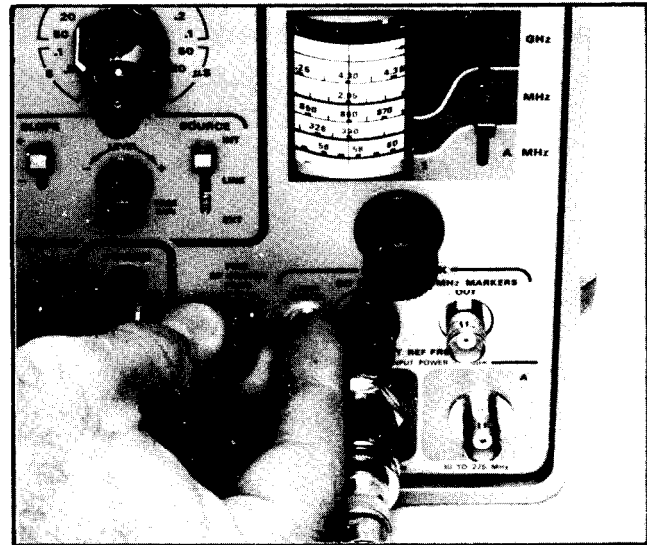

Fig. 2-15. Adjusting FINE RF CENTER FREQ control for phase lock operation.

When searching a frequency band, set the MIXER PEAKING control to SEARCH position and tune slowly through the band with the RF CENTER FREQUENCY control. This ensures that signals of sufficient power within a tunable range will be observed. See Mixer Peaking. After the signal has been located adjust the MIXER PEAKING to optimize signal amplitude.

#### NOTE

MIXER PEAKING control must not be in the SEARCH position when making relative amplitude measurements and should be adjusted for maximum signal amplitude.

### Phase Lock Operation

The 1st local oscillator can be phase locked to either an internal 1 MHz reference oscillator or an external frequency source when it is applied to the EXT REF FREQ IN connector. Locking the local oscillator to a stable frequency, such as the internal 1 MHz crystal controlled oscillator, reduces the local oscillator incidental frequency modulation and frequency drift. This allows narrow dispersion and high resolution settings for signal analysis.

The frequency range of an external reference frequency is 1 MHz to 5 MHz, and amplitude limitations are 1 to 5 volts peak to peak. The external signal for phase lock operation is applied to the phase lock circuit when the INT REF FREQ control is turned ccw to the OFF OR EXT REF FREQ IN position.

The LOCK CHECK pushbutton applies the output of the phase lock amplifier to the vertical display system. The output of the phase lock amplifier contains the following: (1) Beat frequency signals between the local oscillator and the reference frequency when the oscillator frequency is very close to a lock with the reference frequency. (2) A DC ref-

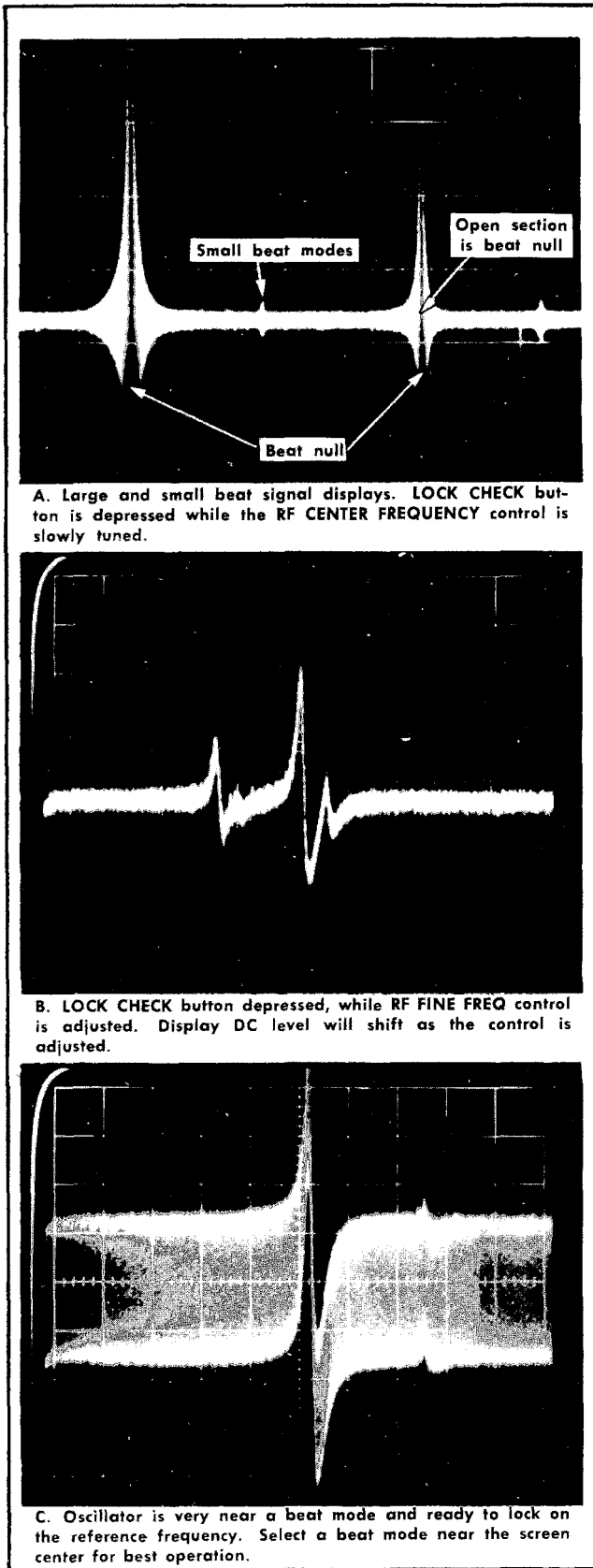

Fig. 2-16. Typical LOCK CHECK displays

reference level of the output amplifier. This DC level changes as the FINE RF CENTER FREQ control is rotated and shifts the local oscillator frequency a slight amount. It also affects the vertical position of the display baseline. Thus, by depressing the LOCK CHECK button and slowly turning the FINE RF CENTER FREQ control (Fig. 2-15), the operator will observe the baseline of the display shift until a lock mode is reached. The baseline will then remain stationary over a portion of the control range as the circuit holds the local oscillator locked to the reference frequency. Turning the control further causes the circuit to lose its lock and the baseline jumps from the locked position.

Beat frequency signals are usually displayed just before a lock point is reached. See Fig. 2-16. However, through part of the frequency range, the phase lock operation may be very positive and the local oscillator will jump from one lock mode to another without displaying the beat signals or the smooth shift of the display baseline between lock points.

When the DC operating level of the phase lock amplifier reaches either extreme (top or bottom of the graticule area) the operation of the amplifier becomes non-linear and compression of the beat signals will be noted. Phase lock operation becomes difficult to achieve. The displayed DC level thus aids in setting a phase lock condition within the linear operating range of the phase lock amplifier.

Part of the input signal is coupled through and displayed when the LOCK CHECK button is pushed. This permits the operator to re-establish a particular lock point that may be lost because of oscillator drift or other reasons. The operator adjusts the FINE RF CENTER FREQ control while observing the display until the signal is again at a particular lock point (the point where the baseline or the signal position locks).

The local oscillator fundamental frequency locks in 1 MHz steps, (from one lock mode to the next) then the internal 1 MHz reference frequency is used for phase lock operation. This produces gaps of as much as 5 MHz in the upper frequency scale, where the upper harmonic of the local oscillator is used. Continuous tuning through these gaps is provided by the INT REF FREQ control. Rotating the control through its range pulls the crystal controlled reference frequency approximately 1 kHz. This is sufficient to shift the local oscillator frequency through these gaps and maintain phase lock operation.

Phase lock operation is established as follows:

1. Tune the desired signal to the center of the display with the RF CENTER FREQUENCY control.

2. Depress the LOCK CHECK button and adjust the FINE RF CENTER FREQ control for a lock indication within the center (4 div) of the graticule. If the lock indication or beat signal is outside the linear operating range of the amplifier (baseline of display at the top or bottom of the graticule), center the display with the FINE RF CENTER FREQ control, then adjust the RF CENTER FREQUENCY control to shift the signal towards a beat mode. Adjust the FINE RF CENTER FREQ control while observing the desired signal for phase lock operation, then release the LOCK CHECK button.

# CONTROL SET-UP CHART

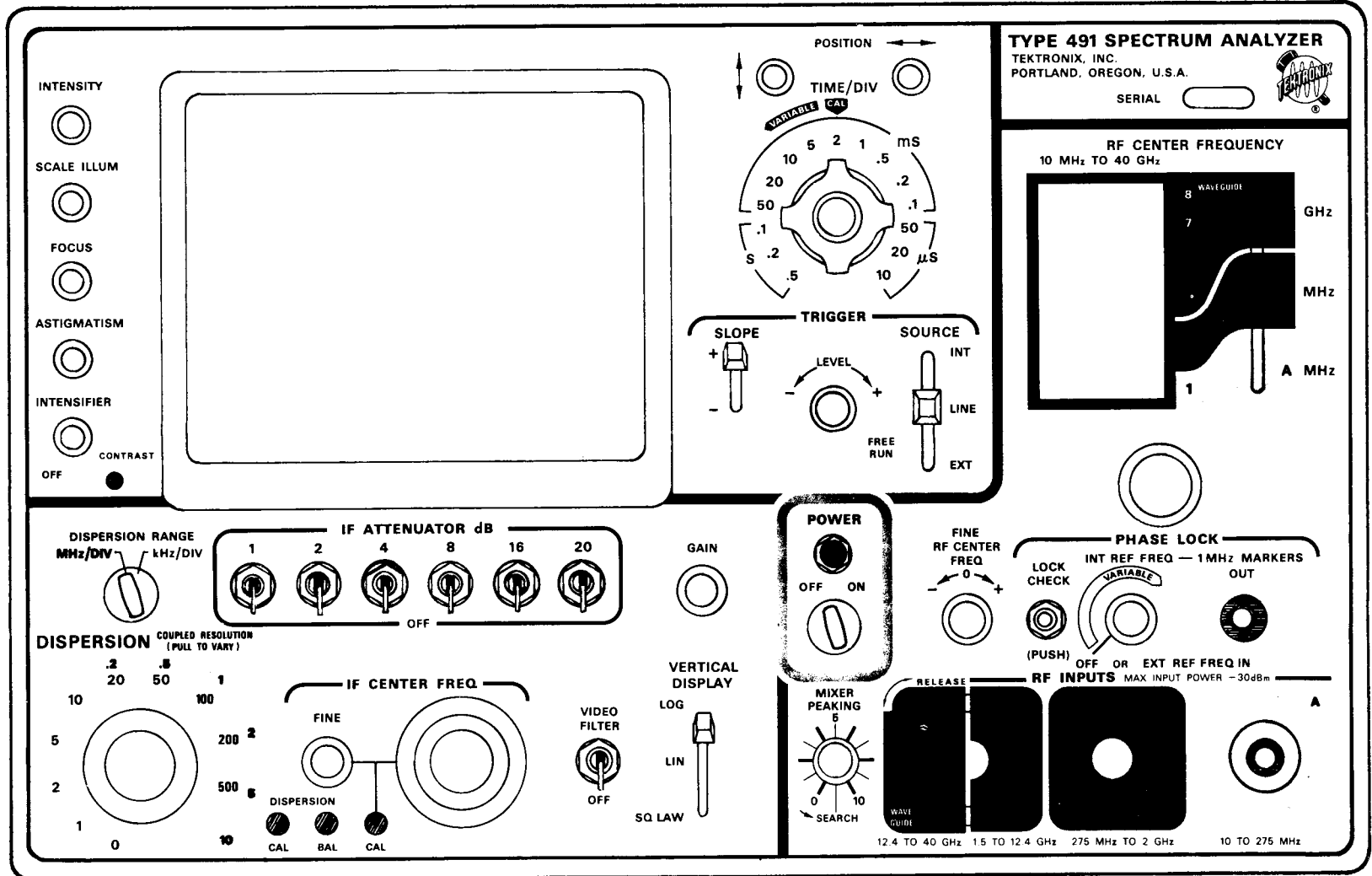

Fig. 2-17. Control set-up chart.



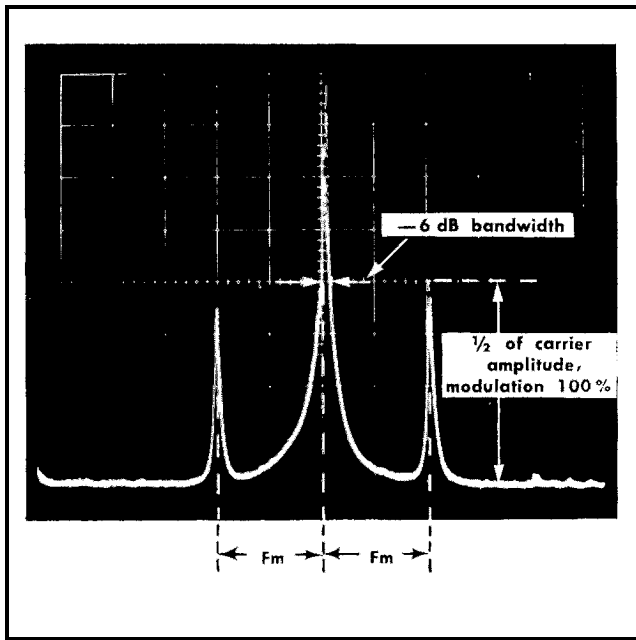

Fig. 2-18. Spectrum of an amplitude modulated signal. Sideband amplitude is  $\frac{1}{2}$  the percentage of modulation. This spectrum shows 100% modulation.

3. Decrease the dispersion to open the screen. Keep the signal centered on screen with the IF CENTER FREQ controls. If the local oscillator should lose its lock condition when the dispersion settings are 100 kHz or less, the signal will disappear from the screen. A slight adjustment of the FINE RF CENTER FREQ control will usually return the signal to the display.

4. If two or more high frequency (upper scale) signals are to be resolved, they can be moved on the display without losing phase lock by adjusting the INT REF FREQ control.

### Recorder Out Connector

Signals on the display may be recorded by connecting to the RECORDER output connector on the rear panel. A linear output is provided when the VERTICAL DISPLAY switch is in the LOG and LIN positions. With the DISPLAY switch in the SQ LAW position, the output to the RECORDER connector is square law.

### Control Setup Chart

Fig. 2-17 is a control setup chart for the front panel of the Type 491. This figure may be reproduced and used as a test setup record for special applications or procedures. It may also serve as a training aid to facilitate control operation.

## SPECTRUM ANALYZER DISPLAYS

The Spectrum Analyzer displays a plot of signal amplitude as a function of frequency. With this type of display, in the frequency domain, individual frequency components in the signal can be displayed and readily analyzed. This section describes some basic spectrum analyzer displays.

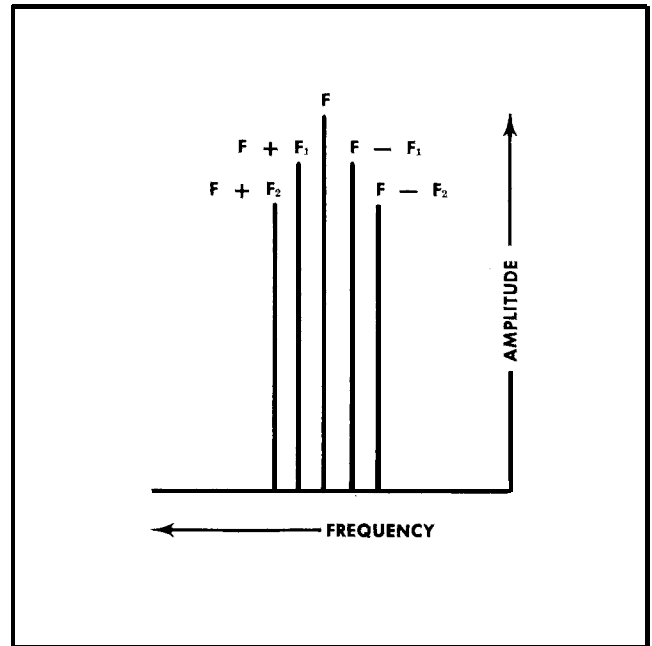

Fig. 2-19. Formation of a spectrum.  $F$  is the fundamental or carrier frequency,  $F_1$  and  $F_2$  are the modulating frequencies.

### Spectrum of Amplitude Modulation

When a single frequency (CW) signal is amplitude-modulated by a single frequency, two additional frequencies will be generated; the carrier plus the two side bands. See Fig. 2-18. The amplitude of either sideband with respect to the carrier voltage is  $\frac{1}{2}$  the percentage of modulation. The frequency difference between the carrier and either sideband equals the modulating frequency.

Figure 2-19 illustrates how a spectrum is generated when a fundamental carrier frequency  $F$  is modulated by two frequencies  $F_1$  and  $F_2$ .

The sideband spectrum of multiple frequency amplitude-modulated signal spectrum is determined by the modulating frequencies. To resolve this complex spectrum, the analyzer resolution bandwidth must be less than the lowest modulating frequency, or the bandwidth must be less than the difference between any two modulating frequencies, whichever is the smaller.

In wideband amplitude-modulation such as television picture information, the spectrum analyzer may be used to measure the sideband energy distribution and modulation bandwidth.

The amplitude modulated signal spectrum will therefore furnish the following information: 1) Fundamental or carrier frequency, 2) modulation frequency or frequencies, 3) modulation percentage, 4) sideband energy distribution and 5) modulation bandwidth. Other characteristics which may be evaluated are; degree of incidental FM (evidenced by signal jitter), nonlinear modulation, and over-modulation. These characteristics will be described in more detail with other types of spectrum display patterns.

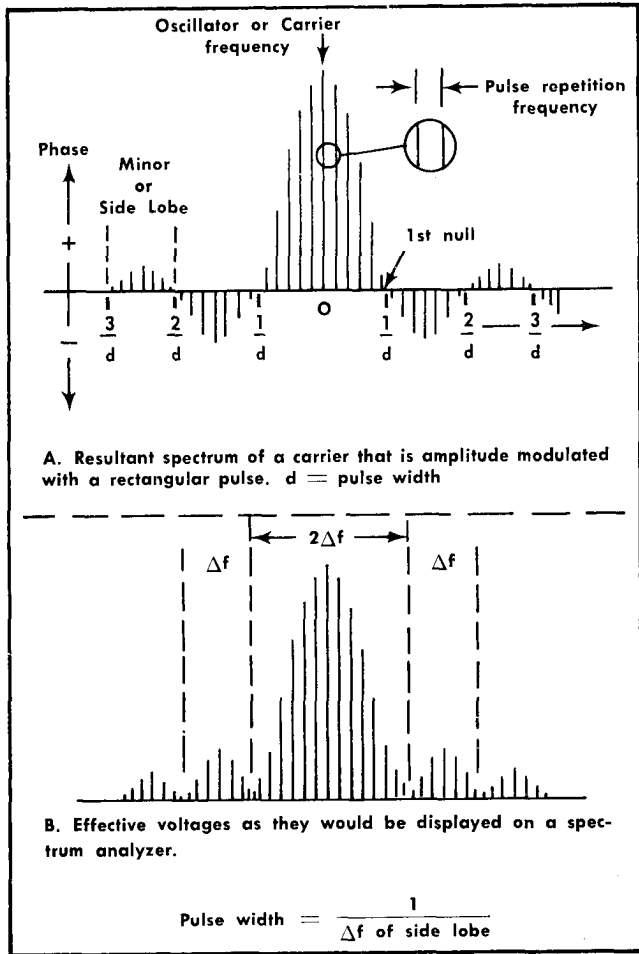

Fig. 2-20. Formation of a pulse modulated signal spectrum.

## Frequency Modulated Signal Spectrum

When a CW signal  $F_c$  is frequency modulated at a rate ( $F_m$ ), it will theoretically produce an infinite number of sideband frequencies. These frequencies are equal to  $(F_c \pm nF_m)$  where  $n = 1, 2, 3$ , etc.

Frequency modulated signal bandwidth is usually determined by the width of the sidebands containing sufficient energy to dominate the display. Signal bandwidth is approximately equal to  $2(\Delta F_c + F_m)$  where  $\Delta F_c$  is the frequency deviation of the carrier and  $F_m$  is the frequency of the modulating signal. Frequency deviation of the carrier is primarily dependent on the modulating signal amplitude.

This ratio of frequency deviation to modulating frequency is known as modulation index. Bessel function and frequency spectrum for different modulation indices may be found in the 4th edition of Reference Data for Radio Engineers, Chapter 19.

To resolve adjacent sideband components in a frequency modulated display, the spectrum analyzer resolution bandwidth should be less than the lowest modulating frequency in the spectrum which is the same as the requirements for an amplitude modulated spectrum.

## Pulse Modulated Signal Spectrum

When a CW signal is pulse modulated, the carrier is periodically turned on and off. The on period is determined by the modulating pulse width, the off periods is related to the pulse repetition rate or frequency. The carrier is usually modulated with rectangular shaped pulses.

A square wave is composed of its fundamental frequency plus the odd harmonics. If the relative amplitudes and phase of the harmonics are changed, a number of waves happens are produced; rectangular, trapezoidal, sawtooth, etc. The spectrum of the square wave or any pulse shape is displayed according to its frequency components and their amplitudes. Common pulse forms and their spectrum are described in Reference Data for Radio Engineers, 4th edition, Chapter 35, ITT 1956.

Fig. 2-20A illustrates a theoretical voltage spectrum of a square-pulse, pulse-modulated oscillator. The main lobe and the side lobes are shown as groups of spectral lines extending above and below the baseline. The number of these side lobes for a truly rectangular pulse, approaches infinity, since the number of harmonics in a square pulse approaches an infinite quantity. Any two adjacent side lobes are separated on the frequency scale by a distance equal to the inverse of the modulating pulse width. See Fig. 2-20A.

Fourier theory shows that adjacent lobes are "180° out of phase; however, since the spectrum analyzer is insensitive to phase, only the absolute value of the spectrum is displayed and appears as illustrated in Fig. 2-20B.

Fig. 2-21 illustrates the relative effects the pulse width and pulse repetition frequency have on a pulsed RF spectrum.

Since the spacing between the spectral lines of the pulsed RF spectrum is a function of the PRF, the spectrum analyzer resolution bandwidth should be less than the PRF to respond to one frequency component at a time. In most instances this is impractical; for example, a short pulse at a PRF of 100 hertz, would require an effective resolution of 100 hertz. This would produce an extremely fine grain display, and would be impractical for analysis.

The spectrum envelope, however, is plotted with pulses instead of lines. If the analyzer is swept slowly, it will plot a series of pips or lines, the focus of which represents the relative energy distribution of the swept spectrum. The number or density of these pips for a given PRF will depend on the sweep speed, or TIME/DIV selection, on the analyzer. It is possible, by sweeping very slowly, to obtain the spectrum of a very low PRF signal. This display closely simulates a pulsed spectrum and contains the same information for analysis. This spectrum may now be resolved, since the resolution bandwidth of the analyzer need only be less than the side lobe frequency width, or the reciprocal of the modulating pulse width. Fig. 2-22 illustrates the effects the pulse shape will have on the RF spectrum. Notice the reduction of side lobes when the pulse is no longer rectangular; Fig. 2-22C.

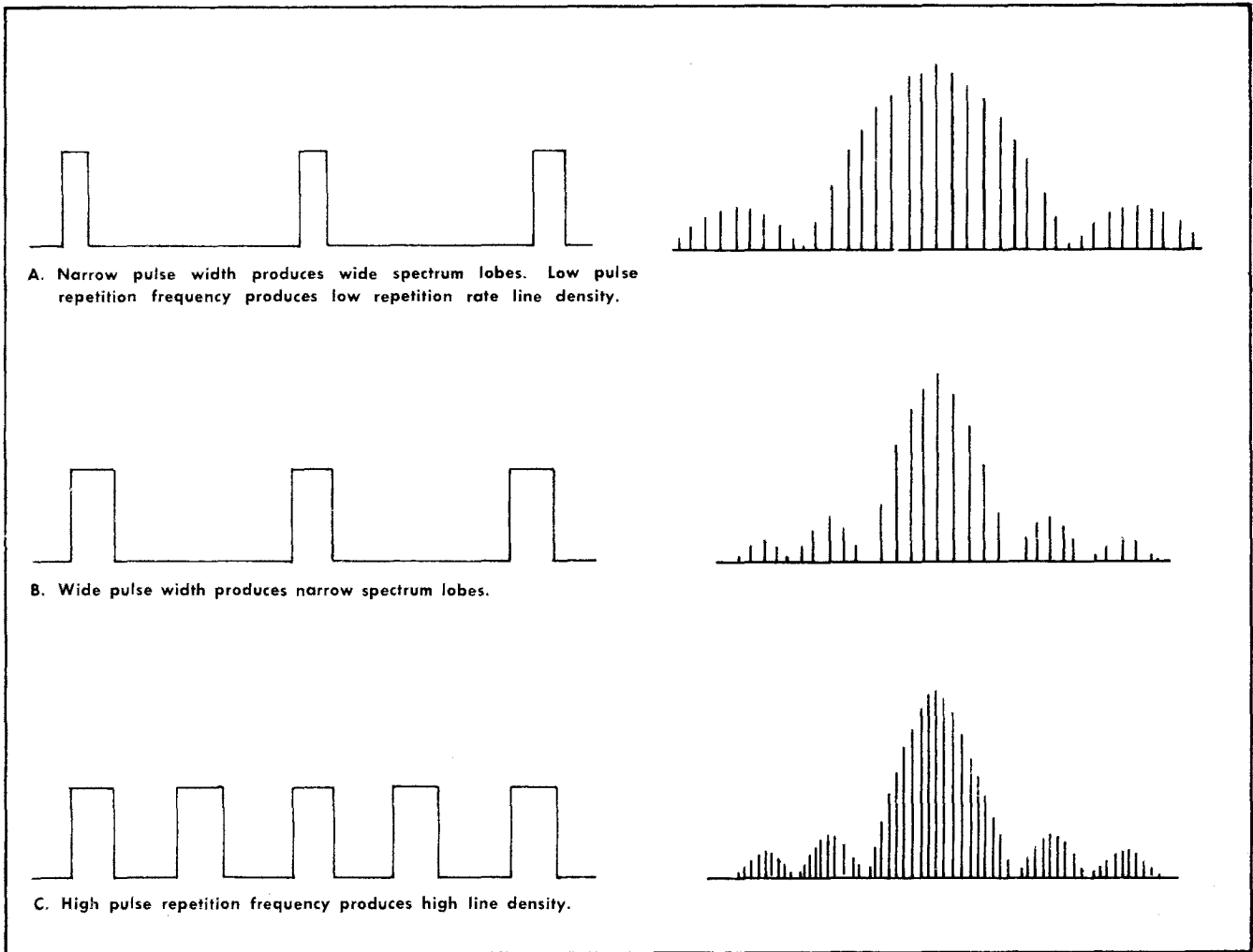

Fig. 2-21. Pulse width and PRF effects on pulse modulated spectrum.

## Identification and Frequency Measurement of Displayed Signals

Bandpass and dispersion characteristics of spectrum analyzers require very limited preselection ahead of the first mixer. Signals with frequencies different than that indicated by the dial will therefore appear on the display. These signals are called spurious responses. See spurious responses under Spectrum Analyzer Terms at the beginning of this section.

The dial scales for the Type 491 indicate frequencies that are below the local oscillator frequency by the IF (200 MHz). For example: a dial reading of 700 MHz means the local oscillator frequency of 900 MHz (700 MHz + 200 MHz). This local oscillator frequency will mix with 700 MHz and 1100 MHz to produce the IF of 200 MHz. The 1100 MHz response is called the image. Note that the image response is twice the IF away from the true, or dial calibrated response. Harmonics of the local oscillator fundamental frequency also convert incoming signals to the IF response. For example,

the second harmonic of 900 MHz (1800 MHz) will mix with 1600 MHz and 2000 MHz.

These responses are identified and read as follows:

1. Tune the RF Center Frequency across a dispersion window and observe the signal movement.
2. True responses move across the dispersion window from left to right, on the Type 491, as the RF CENTER FREQUENCY is increased, or in the same direction as the tuning knob is turned.
3. Images move across the dispersion window opposite to the direction of the true response.
4. IF feedthrough signals are not tunable and remain fixed in position as the RF CENTER FREQUENCY is tuned.
5. Signal frequency shifts across the dispersion window that are not coincident with the RF CENTER FREQUENCY change are spurious. Some of these spurious are mixing with higher harmonics of the local oscillator. The upper dial scales of the Type 491 are calibrated to harmonics of the local os-

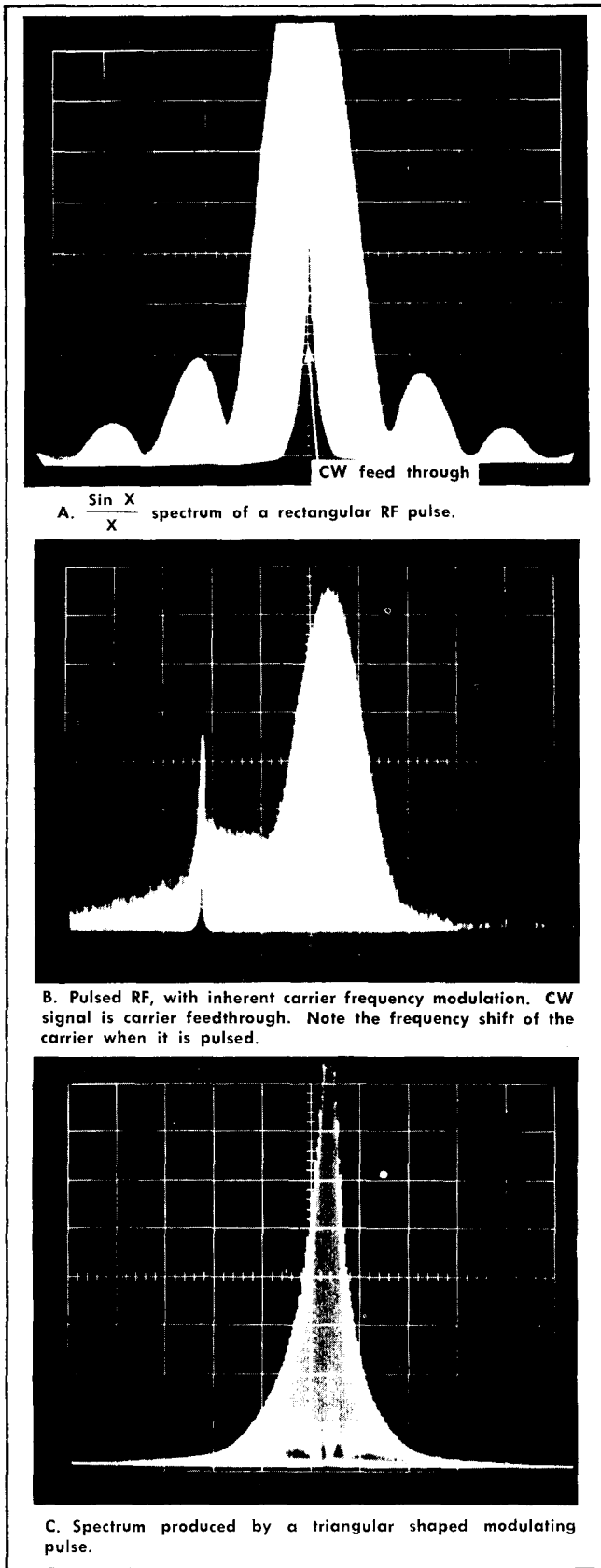

Fig. 2-22. Pulse shaping effects on the pulse spectrum.

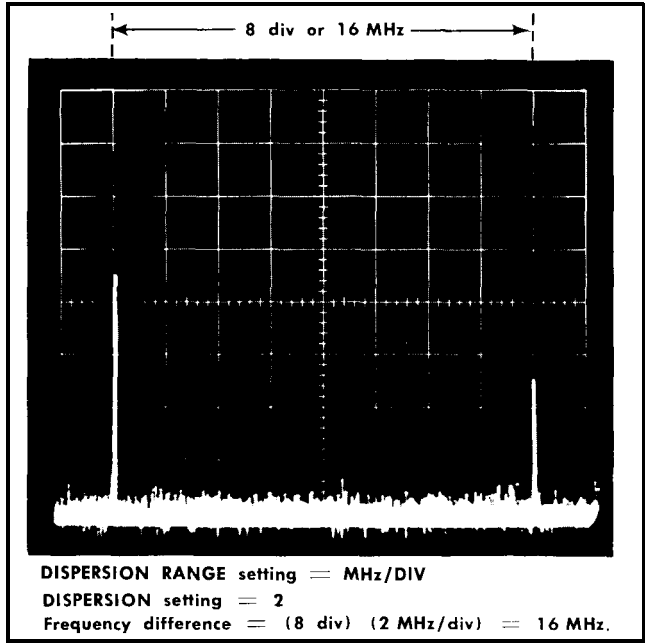

Fig. 2-23. Frequency difference measurement between two signals.

cillator fundamental. If an incorrect dial scale is used to measure the frequency movement of the signal, as the RF CENTER FREQUENCY is tuned, an erroneous reading will be obtained. This erroneous reading however can be used to identify which scale to use to obtain the correct frequency reading. For example: With a dispersion of 5 MHz/div (50 MHz total) a given signal moves 50 MHz for a RF CENTER FREQUENCY change of 25 MHz. This indicates the signal is mixing with the next higher harmonic of the oscillator, and the next higher scale should be used to read the signal frequency. If the signal only moves 25 MHz for an RF CENTER FREQUENCY change of 50 MHz, the next lower scale should be used.

6. The rate at which the signal moves across the dispersion window as the RF CENTER FREQUENCY is tuned also aids in identifying which scale to use, and with practice, the correlation of the signal rate of movement and the dial scale becomes fairly easy.

Spurious responses due to intermodulation are the most difficult to identify. Signal characteristics, such as type and amount of modulation, irregular spacing between signals, etc., are the main character identities.

## APPLICATIONS

The spectrum analyzer is a very versatile device in the field of radiation measurements. It can be used for example, as an aid in the design and adjustment of transmitters, to check and calibrate oscillators, check and calibrate attenuators, or as a sensitive detector device to study all types of modulated signals, plus many more special applications.

The following are basic applications for the Type 491 and are presented to illustrate some of these uses in the electronics field.

## Relative Amplitude Measurements

The relative amplitudes of signals are measured as follows:

1. Center the IF CENTER FREQ controls. Switch out any IF ATEN. Tune the signal with the lowest amplitude to the center of the screen.
2. Adjust the GAIN control so the low amplitude signals establish a reference amplitude.
3. Tune the stronger signal to the center of the display. Add IF attenuation by switching combinations of IF ATTENUATION until the stronger signal amplitude decreases to the same reference amplitude established in step 2.
4. Add the total attenuation that was switched in. This is the relative amplitude difference, in dB, between the two compared signals.

### NOTE

**For maximum accuracy, the signals should be referenced and compared near the same location on the display. Tune each signal to the reference location with the RF CENTER FREQUENCY control. The IF CENTER FREQ, the DISPERSION-COUPLED RESOLUTION, the FINE RF CENTER FREQ, and the TIME/DIV controls should not be changed when measuring relative signal amplitude.**

The peak amplitude of the main lobe of a pulse modulated RF spectrum represents only a portion of the total energy contained in the lobe. The main lobe is less than the amplitude of an equal peak value CW signal, by an amount which is approximately  $3/2\pi B$ ; where  $t$  is the measured pulse width in seconds, and  $B$  is the selected resolution bandwidth of the analyzer in hertz. Spectrum Analyzer sensitivity measurements should therefore be made with a CW signal.

## Frequency Measurements

Frequency measurements taken from the RF CENTER FREQUENCY dial are accurate to within  $\pm (2 \text{ MHz} + 1\% \text{ of the dial reading})$ . The frequency of an applied signal is measured as follows:

1. Check the calibration of the IF CENTER FREQ CAL adjustment as described under Front Panel adjustments.
2. Set both IF CENTER FREQ controls and the FINE RF CENTER FREQ control to their midrange (000) position.
3. Set the DISPERSION RANGE switch to kHz/DIV and the DISPERSION selector to 500 kHz/div.
4. Tune the RF CENTER FREQUENCY so the signal to be measured is in the graticule center.

5. Read the frequency indicated on the RF CENTER FREQUENCY dial. The signal frequency is the dial reading  $\pm (2 \text{ MHz} + 1\% \text{ of the dial reading})$ . For example: A dial reading of 1000 MHz indicates the signal is 1000 MHz  $\pm (2 \text{ MHz} + 10 \text{ MHz})$  or, between 988 MHz and 1012 MHz

Accurate frequency measurements can be performed by applying a calibrated or crystal-controlled frequency to the RF INPUT and calibrating the dial near the frequency range of the input signal; then tune the input signal to the same screen position and note the dial reading plus or minus the measured dial accuracy.

## Frequency Difference Measurements

Frequency separation measurements to 100 MHz can be made between signals as follows:

1. Switch the DISPERSION RANGE switch and the DISPERSION selector so the signals to be measured are the maximum number of graticule divisions apart on the display.
2. Set the TIME/DIV selector and the RESOLUTION control for optimum signal definition. [Sharp and clean signal display.]
3. Measure the distance, in graticule divisions, between the two signals (see Fig. 2-23.)
4. Multiply the measured distance in step 3 by the Dispersion/Div setting. This is the frequency separation or frequency difference between the two signals.

### NOTE

**Accuracy of this measurement depends on the DISPERSION RANGE settings. See Characteristics Section.**

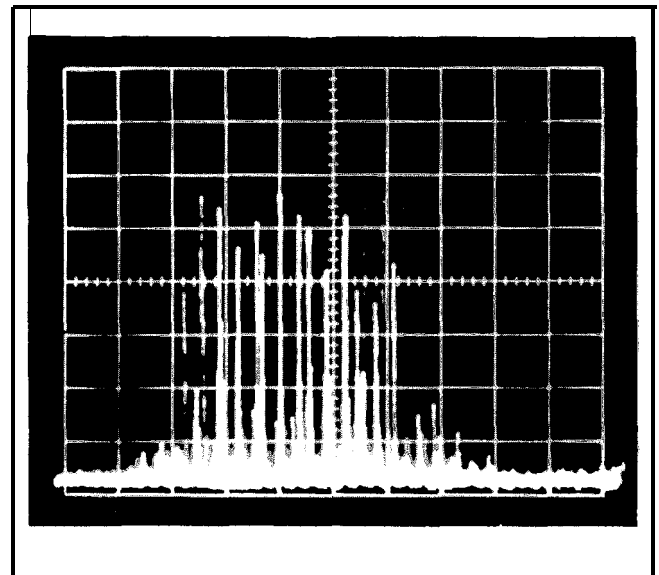

Fig. 2-24. Short term stability measurement. Random FM characteristic of a klystron. DISPERSION is 2 kHz/Div and RESOLUTION is 1 kHz. Oscillator FM is about 6 kHz.

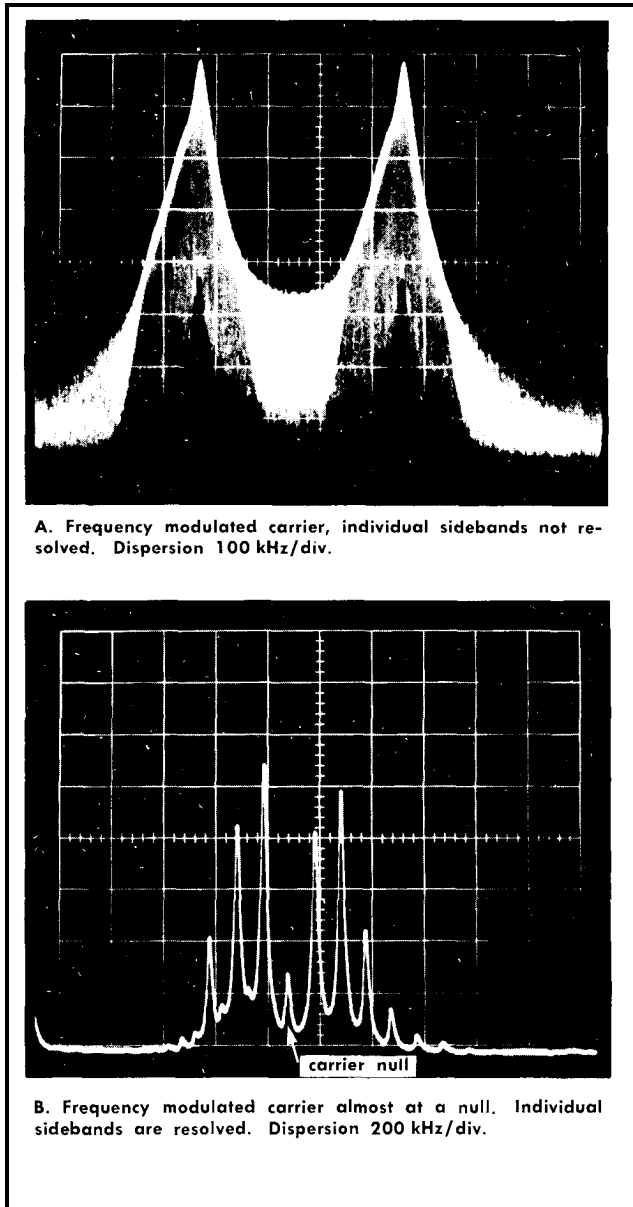

Fig. 2-26. Amplitude modulated displays.

### Frequency Stability

The Type 491 can be used to measure long and short term frequency stability, when the local oscillator is phase locked to a stable crystal-controlled reference frequency. See Stability in Characteristics Section.

Short term stability measurements apply to fast frequency changes such as those caused by power supply noise and ripple, vibration or other random factors. Fig. 2-24 shows the random frequency modulation characteristics of a klystron.

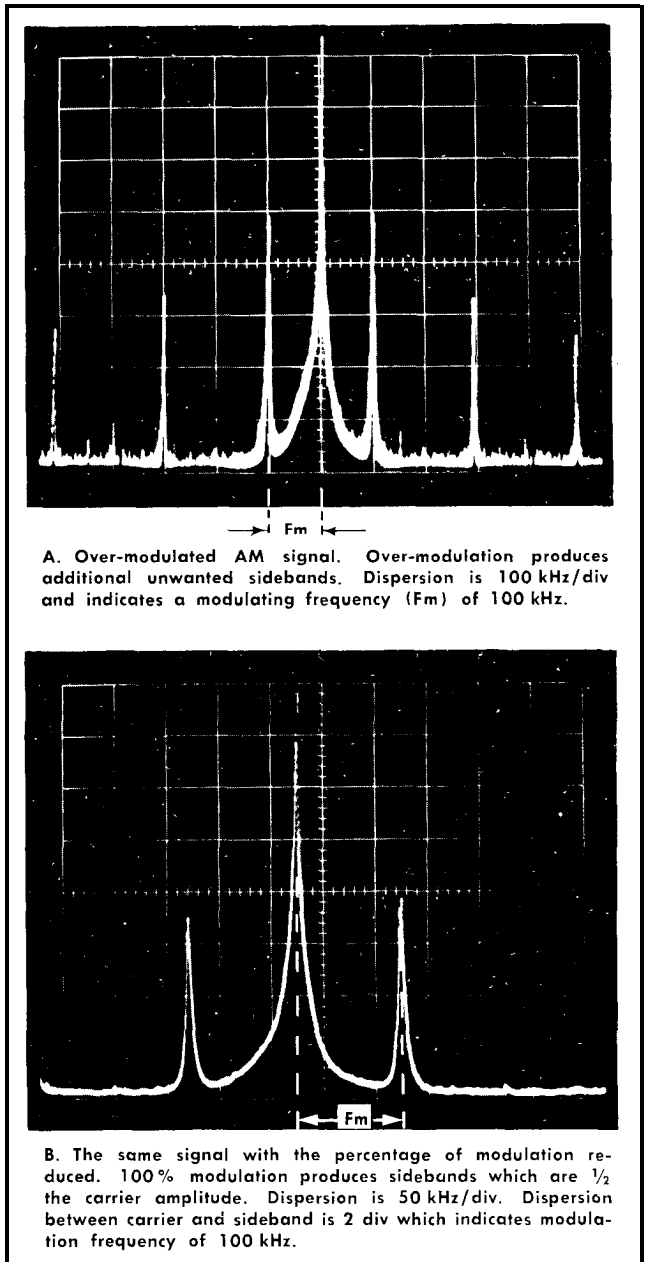

Fig. 2-25 Frequency modulated displays.

Long term stability measurements require a recorder or a series of photographs to show the frequency drift as a function of time. Temperature compensation can be recomputed by this process, since the amount and direction of the drift may be graphically indicated by photographs.

### Amplitude Modulation

Modulating frequency or frequencies and modulation percentage are the figures most often required from an AM signal measurement. Fig. 2-25 shows two illustrations of amplitude modulated signals, the methods to measure the modulating frequency and modulation percentage.

Over modulation will produce extra sideband frequencies. The spectrum is very similar to multi-frequency modulation. Over modulation, however, is usually distinguished from the multi-frequency modulation by: 1) The spacing between over-modulated sidebands is equal, while, multi-frequency sidebands may be arbitrarily spaced, unless the modulating frequencies are harmonically related; 2) The amplitude of the sidebands decreases progressively out from the carrier, but, the amplitude multifrequency modulated signals is determined by the modulation percentage of each frequency and can be arbitrary.

### Frequency Modulated Spectrum

FM measurements are generally measurements that determine; the modulating frequency, amplitude of the modulating signal or frequency deviation, and index of modulation. A typical FM spectrum is shown in Fig. 2-26. The exterior modulation envelope resembles a  $\cos^2$  curve, and identifies the signal as frequency modulation.

### Frequency Deviation Measurement

There is no clear relationship between spectral width and deviation, because in theory the FM spectrum approaches infinity. In practice however the spectral level falls quite rapidly as shown in Fig. 2-26B.

Accurate deviation measurements can be made if the modulating frequency and the modulation index (where the carrier goes to zero) are known.

$$\text{Modulation Index} = \frac{\text{Carrier deviation}}{\text{Modulating frequency}}$$

Values of modulation index corresponding to zero carrier amplitude are listed in Table 2-1.

TABLE 2-1

Values of modulation index for carrier null points	
Order of Carrier Null	Modulation Index
1	2.4
2	5.52
3	8.65
4	11.79
$n (n > 4)$	$11.79 + \pi (n - 4)$

Accurate carrier null is essential for accurate measurement.

### Pulse Modulated RF Spectral Measurements

A visual examination of the pulse modulated spectrum can check a number of the characteristics about a transmitting and modulating device. Some of these characteristics are:

1, The transmitting oscillator stability can be checked by noting the degree of frequency shift as described previously.

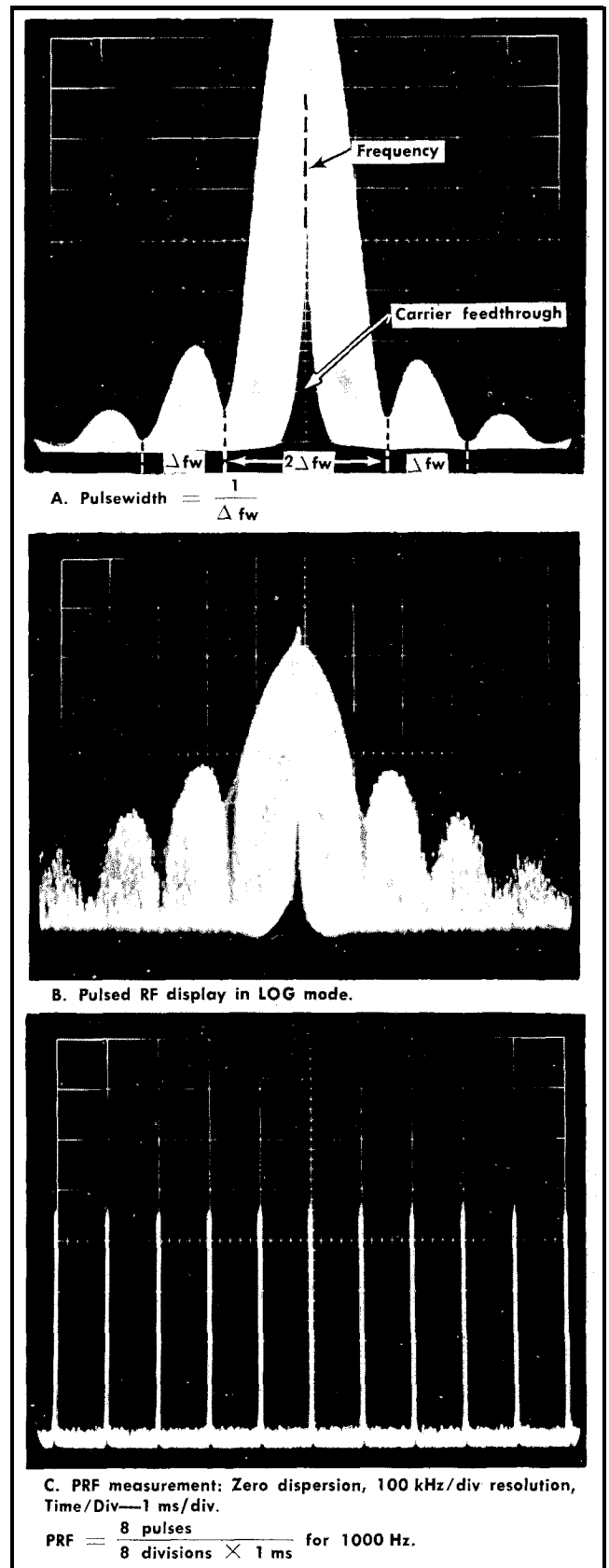

Fig. 2-27. Pulse modulation display, illustrating pulse width and PRF measurements.

2. A visual means is provided to tune the transmitting system and obtain most of the output power within the frequency range of the receiver bandwidth.

3. The frequency difference between the first two minima of any spectrum is a measure of the modulating pulse width. See Fig. 2-27.

4. A spectrum without deep minima points adjacent to the main lobe indicates the presence of frequency modulation. See Fig. 2-22.

5. If the spectrum has two peaks, the oscillator is operating in two modes or it is pulled in frequency by some external factor, such as mismatched transmission lines or fluctuating voltages (providing the resolution of the analyzer is sufficient).

## Measurements of Pulse Modulated RF Signals

**Pulse Width:** Since the theoretical pulse width for a square pulse is the reciprocal of the spectral side lobe frequency width, the main frequency lobe or its side lobes can be used to measure the pulse width of the pulse modulated spectrum. This is accomplished with the Type 491 as follows:

1. Adjust the DISPERSION control and tune the RF CENTER FREQUENCY control so the main lobe of the spectrum is displayed in the center of the graticule, and the side lobes are visible on each side.

2. Adjust the GAIN control and switch in the necessary IF ATTENUATION dB switches, so the main lobe and its side lobes are within the graticule height.

3. Adjust the TIME/DIV selector for optimum spectrum definition,

4. Adjust the RESOLUTION control so the nulls are easily discernible without excessive loss of sensitivity. Change the mode selection of the VERTICAL DISPLAY switch to accentuate these minima points. (Usually LOG position.)

5. Calculate the dispersion of either the main lobe or a side lobe as directed under measuring frequency difference.

The pulse width is equal to the reciprocal of  $\frac{1}{2}$  the main lobe frequency width, or the reciprocal of the side lobe frequency width. See Fig. 2-27.

**Repetition Rate:** The pulse repetition rate is measured when the spectrum analyzer is switched to zero dispersion and the analyzer becomes a fixed tuned receiver. The sweep is then triggered on the signal and becomes a time domain display. The procedure is as follows:

1. Tune the signal to the display center with the RF CENTER FREQUENCY and the IF CENTER FREQ controls.

2. Change the DISPERSION RANGE switch to kHz, then decrease the DISPERSION to 0. Uncouple the RESOLUTION control and turn to the fully clockwise position. The analyzer is now a fixed frequency device with no dispersion.

3. Set the Trigger SOURCE switch to INT, the SLOPE switch to + position, then adjust the LEVEL control for a stable display. The IF CENTER FREQ-FINE control may require slight adjustment to displace the spectrum null point from the sweep start. See Fig. 2-14. The Type 491 requires a 0.2 divisions of signal to trigger internally.

4. Set the VARIABLE control to the CAL detent then adjust the TIME/DIV selector so several pulses of the received signal are displayed. See Fig. 2-27C. The number of pulses displayed is now a function of the sweep rate and the signal PRF.

5. Measure the number of divisions between 2 or more pulses on the graticule.

6. The pulse repetition frequency is the reciprocal of the period between pulses.

In the example of Fig. 2-27C, the repetition time is

$$\frac{(8 \text{ div}) (1 \text{ ms/div})}{(8 \text{ pulses})} = 1 \text{ ms}$$

The pulse repetition frequency (PRF)  $\frac{1}{1 \text{ ms}}$  or 1000 Hz.



# SECTION 3

## CIRCUIT DESCRIPTION

### Introduction

The Type 491 Spectrum Analyzer is a swept IF type analyzer covering the frequency range from 10 MHz to 40 GHz. This section first presents a block diagram analysis, then a more detailed circuit description of each major section.

### Basic Description

A block diagram of the Type 491 is shown in Fig. 3-1 and the Diagrams section.

Signals within the frequency range of the Type 491 that are applied to the RF INPUT are converted by the heterodyne process to the first intermediate frequency. This is a wide band IF of 150 MHz to 250 MHz. Three selectable local oscillators, in combination with selected mixers, provide the 10 MHz to 40 GHz frequency coverage for the instrument. A phase lock circuit locks the local oscillator to a stable (internal or external) reference frequency. This provides the required stability necessary for narrow dispersion displays.

One or two [depending on the selected band] low pass filters (265 MHz and 235 MHz) plus the 150 MHz to 250 MHz bandpass filter between the first mixer and the wide band IF amplifier, attenuate and isolate local oscillator frequencies which would generate spurious signals when mixed with the second local oscillator frequency.

The wide band (150 MHz to 250 MHz) IF response is then swept, in the second mixer, by a swept frequency to generate a second IF of 75 MHz. The swept frequency rate of the oscillator is synchronized to the sweep rate so the CRT display becomes frequency based with a dispersion window that depends on how much the oscillator is swept.

Center frequency of the swept oscillator is 275 MHz. The amount the oscillator sweeps depends on the selected dispersion. At maximum dispersion the oscillator sweeps 225 MHz to 325 MHz, which converts all signals within the wide band IF to the second 75 MHz IF.

Calibrated attenuation in steps of 1 to 51 dB is provided by the IF attenuator. The signal is then amplified and applied to the 3rd mixer stage, where it is mixed with 70 MHz to produce a 3rd IF frequency of 5 MHz. The bandwidth of this 5 MHz IF is varied by means of the variable resolution circuit which provides resolution control from approximately 100 kHz to less than 1 kHz.

Video signals from the detector are amplified by the vertical amplifier, then applied to the CRT vertical deflection plates and to the trigger circuit for the sweep generator, provided the Trigger SOURCE selector is in the INT position. The sweep generator will free run, or it can be triggered from any one of three selectable sources; line, external and internal.

The signal from the sweep generator is applied to both the sweeper oscillator through the variable dispersion circuit

and to the horizontal amplifier circuit for the horizontal sweep on the CRT. The horizontal CRT beam movement and the frequency scan in the 2nd mixer are therefore synchronized. This provides the calibrated dispersion and a linear display of the frequency spectrum on either side of the dial center frequency.

The 1st or tunable local oscillator is phase-locked to a stable crystal-controlled reference frequency by the phase locking circuit. This stabilizes the local oscillator frequency and permits narrow 1 kHz/div dispersion settings.

### RF Section

The RF section contains three local oscillator assemblies, for each band, and their respective mixers. Two low-pass filters (235 and 265 MHz) are switched in series with the signal path between the band A mixer and the IF band-pass filter. Only the 265 MHz low-pass filter is used for bands B and C. The band selector switch SW70 selects the filters and connects only one oscillator circuit to the +150 volt supply. Only one oscillator is operating for a given band switch position. The 235 MHz low pass filter attenuates the low frequency end of the band A oscillator.

Heater voltage for the oscillators is supplied by the +10 volt regulated supply. Thus, oscillator frequency drift due to heater voltage variation is minimized. The heater supply line to V40 and V41 includes a series dropping resistor, R45 and R46, to reduce the voltage for these tubes to 6 volts.

Lossy cables (such as W10-W34, etc.) are used to reduce SWR caused by slight impedance mismatch between circuits. Impedance mismatches may be due to coaxial connectors or other discontinuities.

#### NOTE

Lossy cables use steel wire for the center conductor. These cables are factory-installed and used to optimize response flatness and sensitivity. The lossy cable is identified by the white insulation coating; the standard 50 W coaxial cable has the clear insulation. Do not interchange these cables.

**Band A:** The oscillator frequency for band A is 200 MHz above the RF input dial reading and has a tunable range of 210 to 475 MHz. The oscillator uses a ceramic planer triode. The tuned circuits are ganged together and tuned by the RF CENTER FREQUENCY control. Frequency tracking of the RF dial is adjusted by variable L and C trimmers, if required.

The band A local oscillator output is applied through a transmission line transformer T14, to the diodes or balanced section of the mixer. Adjustment of R13, C14 and C16 for balance greatly reduces local oscillator feed-through. The desired difference frequency is coupled to the IF amplifier through the 235 MHz filter.

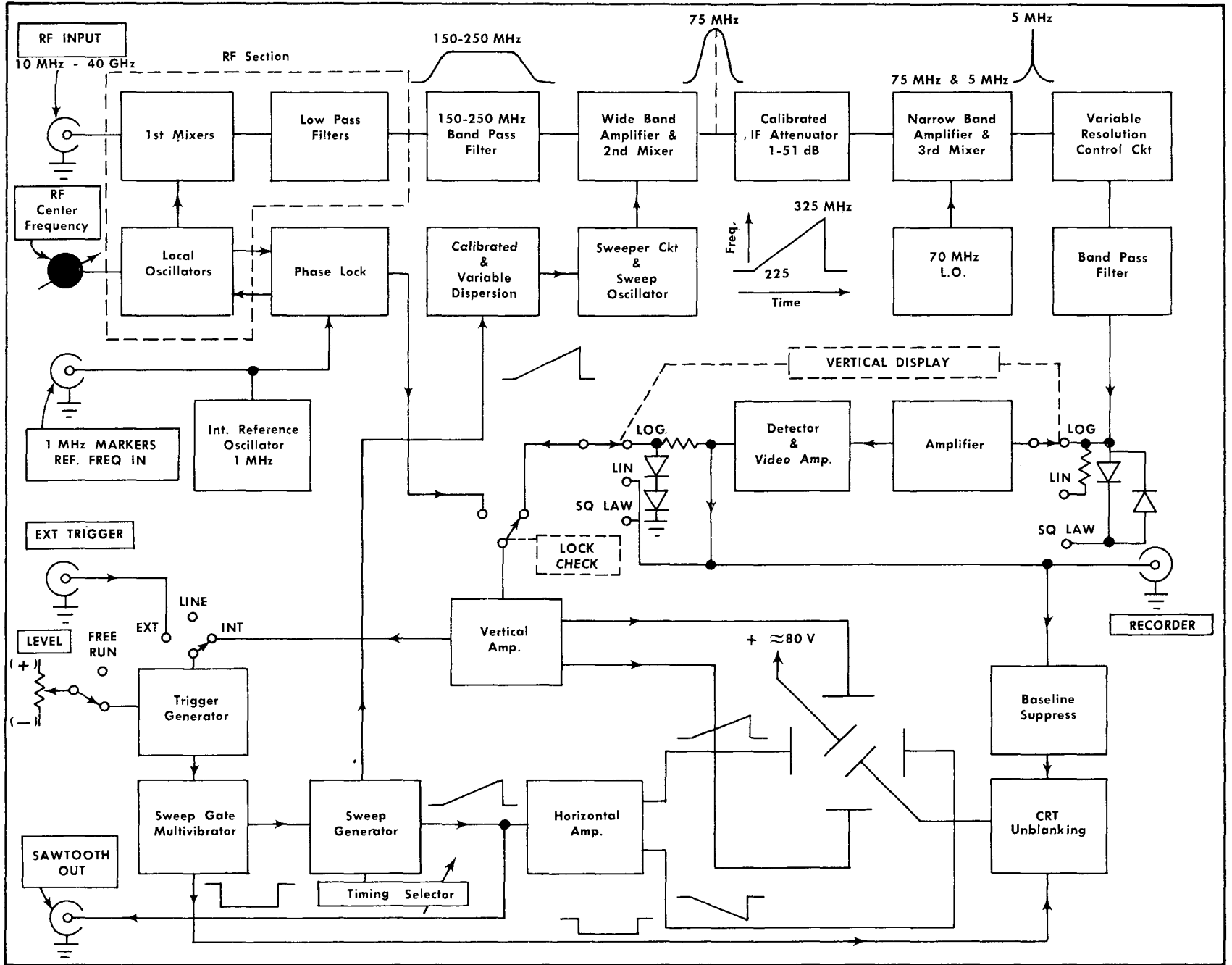

Fig. 3-1. Function block diagram of the Type 491.

**Band B:** The oscillator for band B is similar to band A oscillator. The fundamental frequency range 470 MHz to 1100 MHz and the 2nd harmonic of the oscillator is used for the frequency range 270 MHz to 2000 MHz for scales 2 and 3.

The mixer for this band is a crystal diode. Input RF is applied through a 1 dB isolation pad to the diode. C68, in series with R68, is tuned for response flatness. An RF choke L67, isolates the IF and provides a DC path for the MIXER PEAKING circuit.

**Band C:** The oscillator for band C is a triode oscillator connected to tunable transmission lines which are tuned by the RF CENTER FREQUENCY control. The oscillator fundamental frequency range is 1.7 GHz to 4.2 GHz. Harmonics through the 10th and the fundamental are used to heterodyne with the input RF to provide the input frequency range from 1.5 to 40 GHz.

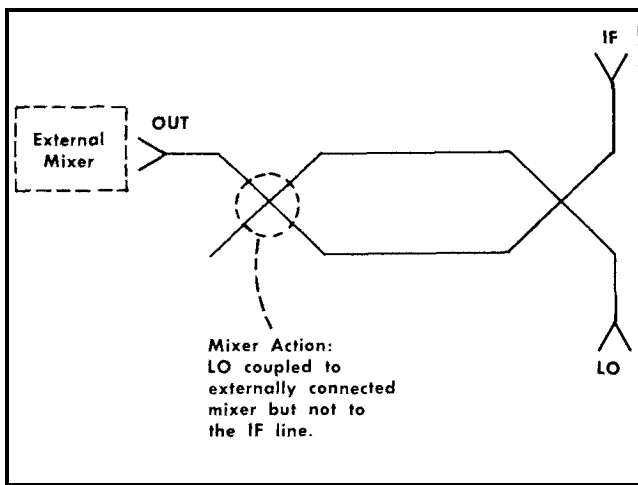

Fig. 3-2. Simplified equivalent of the hybrid directional coupler.

The oscillator output is applied to a hybrid directional coupler or diplexer; see Fig. 3-2. The diplexer couples the LO signal to the mixer port (OUT) and the mixer output to the IF port. The mixer action is therefore in an externally connected mixer, which may be either coaxial or waveguide, and the 200 MHz IF is then coupled through the diplexer to the IF connector.

The C band frequency range requires the following four mixers: One coaxial mixer for the frequency range 1.5 to 12.4 GHz, and three wave guide mixers with frequency ranges of 12.4 to 18 GHz, 18.0 to 26.5 GHz and 26.5 to 40 GHz.

The IF output is applied through a 1 dB attenuator pad and the 265 MHz low-pass filter. DC return for the mixer is through the 1 dB attenuator to the mixer peaking circuit. The mixer peaking circuit has two modes of operation, a search mode and a manual mode. In the search mode, the sweep voltage from the sweep generator circuit is applied to the base of Q65 and Q51. This varies the collector-to-emitter resistance and establishes a variable mixer diode current so that optimum mixer peaking is provided at some point through the sweep scan.

If the local oscillator is slowly tuned through a frequency range, signals above the specified sensitivity level will appear above the noise when they reach this optimum point. This ensures optimum search capability, and when a signal is intercepted, the operator then switches to manual tuning and optimizes the mixer for the given RF center frequency.

## Phase Lock Circuit

The phase lock circuit synchronizes the local oscillator frequency with a stable reference frequency. This reduces oscillator drift and incidental frequency modulation, permitting narrow dispersion settings for signal analysis.

The phase detector samples the instantaneous RF voltage generated by the tunable local oscillator at a rate determined by the reference frequency. The sample voltages are then integrated and applied to a comparator which generates a corrective voltage to feed back to the local oscillator.

When the local oscillator frequency is an exact multiple of the reference frequency, the phase detector output is a DC voltage that is proportional to the instantaneous potential of the sampled oscillator voltage. If the local oscillator phase drifts, the phase detector output changes. This change is amplified through Q1170-Q1180 and applied as a corrective voltage to a voltage-controlled capacitance diode in the oscillator tuned circuit. This shifts the phase of the oscillator so it remains locked with the reference frequency. See Fig. 3-3.

The corrective signal from the comparator and amplifier is also applied to the vertical circuit when the LOCK CHECK button SW889 is depressed. This provides a beat frequency signal indication on the CRT so the operator can locate a lock point. Beat frequency displays appear on the CRT screen as the local oscillator is tuned (see Operating section). A reference voltage related to the position of the FINE RF CENTER FREQ control is also applied to the vertical deflection circuit and is used to center the error signal within the dynamic operating range of the comparator amplifier Q1170-Q1180. Phase lock operation should be set within the dynamic range of the amplifier, preferably in the center of the dynamic range. This dynamic range is visually displayed on the CRT as a vertical displacement of the display.

## Circuit Analysis

Turning the INT REF FREQ control clockwise closes SW1106 so collector voltage is applied to Q1100. The crystal controlled 1 MHz oscillator will now operate. The output 1 MHz signal from the emitter of Q1110 is applied to the trigger generator circuit. Diodes D1122 and D1123 set the quiescent current through the tunnel diode D1124 and couple the signal to the 1 MHz MARKER OUT connector J1120; or, if an external reference signal is applied, they couple the signal to the trigger generator circuit.

Frequency of the reference oscillator Q1100 is primarily controlled by the crystal Y1104, inductor L1104, and the capacitance of diodes D1116 and D1117. Diode D1116 is back biased to act as a voltage-controlled capacitance diode; however, when signal amplitude across crystal Y1104 becomes excessive, D1116 will conduct on the peak signal swing. D1117 then becomes back biased and acts as the capacitance diode.

The back bias across D1116 is controlled by INT REF FREQ control R1106. This change in back bias increases or decreases the diode capacity and shifts the resonant frequency of crystal Y1104. The pulling range on the crystal frequency by the INT REF FREQ control is about 1 kHz. This is sufficient to maintain phase lock condition through frequency gaps that occur above 1 GHz when the oscillator shifts phase lock mode,

When the local oscillator shifts to a different lock mode, the fundamental frequency of the oscillator shifts 1 MHz. This produces frequency gaps in the upper scales which will shift the signal off screen with dispersions of 100 kHz/div or less. The INT REF FREQ control shifts the reference oscillator frequency about 0.1% (1 kHz). This shifts the local oscillator by the same percentage, so the frequency gaps between lock modes are filled. If the observed signal should shift off screen, it can be returned on screen or slid along the display by the INT REF FREQ control.

The pulse generator consists of tunnel diode D1124, driving amplifier Q1120. The quiescent current of tunnel diode D1124 is approximately 2.5 mA. The positive-going portion of the input reference signal switches the tunnel diode to its high state and a fast rise positive pulse is generated. The pulse is amplified and differentiated by Q1120 and the short RC time constant in the emitter circuit.

The output pulse of Q1120 is transformer coupled through T1128 to Q1121. The positive portion of the coupled pulse is of sufficient amplitude to trigger Q1121 into avalanche, and the resulting collector current sweeps out the stored

charge of diodes D1134 and D1139. When the charge has dissipated, the diodes generate a fast recovery step. This recovery step is differentiated and coupled through transmission line transformer T1140, T1150 and T1160 to the phase detector as a series of equal amplitude positive and negative strobe pulses.

The phase detector (Fig. 3-4) consists of a two diode gate and a low pass filter network. The diode gate is turned on by the combined application of the local oscillator signal and the very narrow strobe pulses. During the on time, the phase detector samples the amplitude and phase of the local oscillator signal and develops a voltage at the output of the filter (C, and the junction of R<sub>1</sub>, R<sub>2</sub>) that approximately equals the instantaneous value of the local oscillator signal.

The sample of the local oscillator signal has a finite width determined by the duration of the strobe pulse. The phase detector operates on either the positive or negative slope of the local oscillator signal, depending on the total difference between the detector output voltage and the phase of the local oscillator signal. The strobe pulse width, therefore, must not exceed one-half period of the highest local oscillator input frequency, which is 4.2 GHz. This period is 0.21 ns.

If the input local oscillator frequency is not a harmonic of the reference frequency, the output of the phase detector is approximately zero. However, as the local oscillator frequency approaches a harmonic of the reference frequency, an AC or beat frequency signal is developed at the detector output. This is amplified and applied through the LOCK

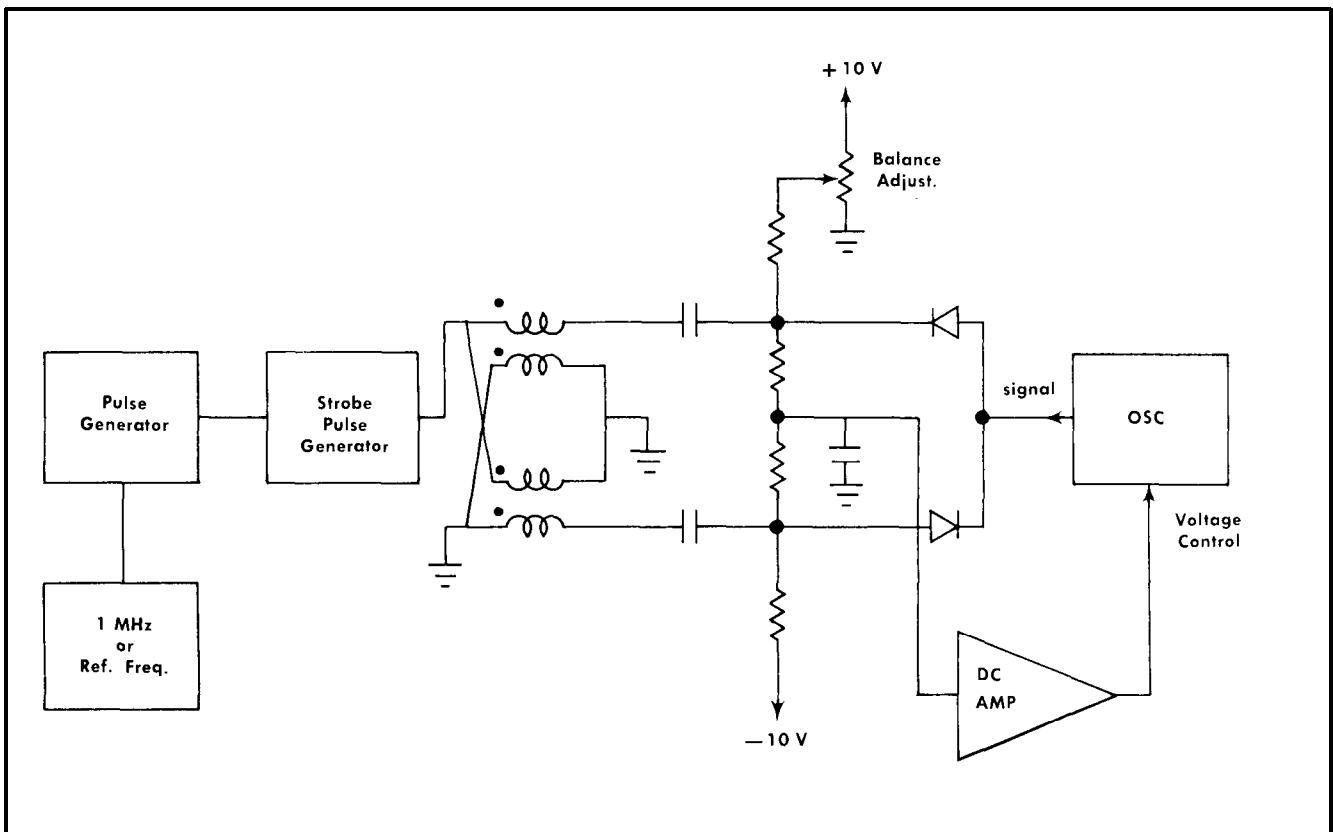

Fig. 3-3. Phase lock block diagram.

CHECK switch to the vertical deflection system. At zero beat, the output signal amplitude snaps to a minimum and the circuit locks the local oscillator to the reference frequency by feeding a corrective voltage to a Varactor diode in the oscillator circuit.

FINE RF CENTER FREQ control R1182 tunes the local oscillator over a limited range by changing the DC output level of Q1180. When the circuit is in a lock condition, any small shift of the FINE RF CENTER FREQ control is counteracted by the phase lock circuit. If the control is further moved the circuit will lose the lock and the oscillator will jump to a different frequency lock point. This jump in frequency is easily seen as a shift in signal position at dispersion settings of 500kHz/div or less.

An isolation switch is used to minimize the loading affect of the lower band (A & B) phase detectors on the band C phase detector. The junction at diodes D1170 and D1174 is returned, through a filter network and the Band selector switch SW70, to +150V. The diodes are forward biased when the Band selector switch is in the A or B position. When the switch is changed to the C position, the diode switch is open.

Band C Bal and Bands A & B Bal adjustments correct any imbalance between the phase detectors so the DC output level of the amplifier remains balanced as the Band selector is switched between bands. The FINE RF CENTER FREQ control must be centered for this adjustment.

## Sweeper Circuit

This circuit (see Fig. 3-5) provides a swept frequency, centered at 275 MHz, to the wide band mixer amplifier. The swept frequency amplitude is constant and the dispersion can be varied from about 0 Hz to 100 MHz.

A positive-going sawtooth voltage from the sweep generator circuit is applied through pin AE to the emitter of Q200. Q200 is configured as a long-tail amplifier. It converts the sawtooth voltage input signal to a linear current ramp, which is applied through the DISPERSION attenuator to one side of comparator amplifier Q220-Q230.

The output DC level of the current ramp from Q200 is set by Sweep Center adjustment R203. Dispersion CAL adjustment R208, shunts the dispersion attenuator. It calibrates the dispersion for the 10 MHz/div position of the DISPERSION selector by adjusting the output amplitude of the current ramp from Q200. The remaining positions the selector are then within instrument specifications.

Two dispersion ranges (MHz/DIV and kHz/DIV) are provided by the DISPERSION RANGE selector R210, which selects a different range of resistance values for each position of the DISPERSION selector.

**Sweep Comparator.** The sweep comparator containing Q220 and Q230 compares the current ramp from the dispersion attenuator against a current ramp applied to the base of Q230. The signal applied to the base of Q230 is the

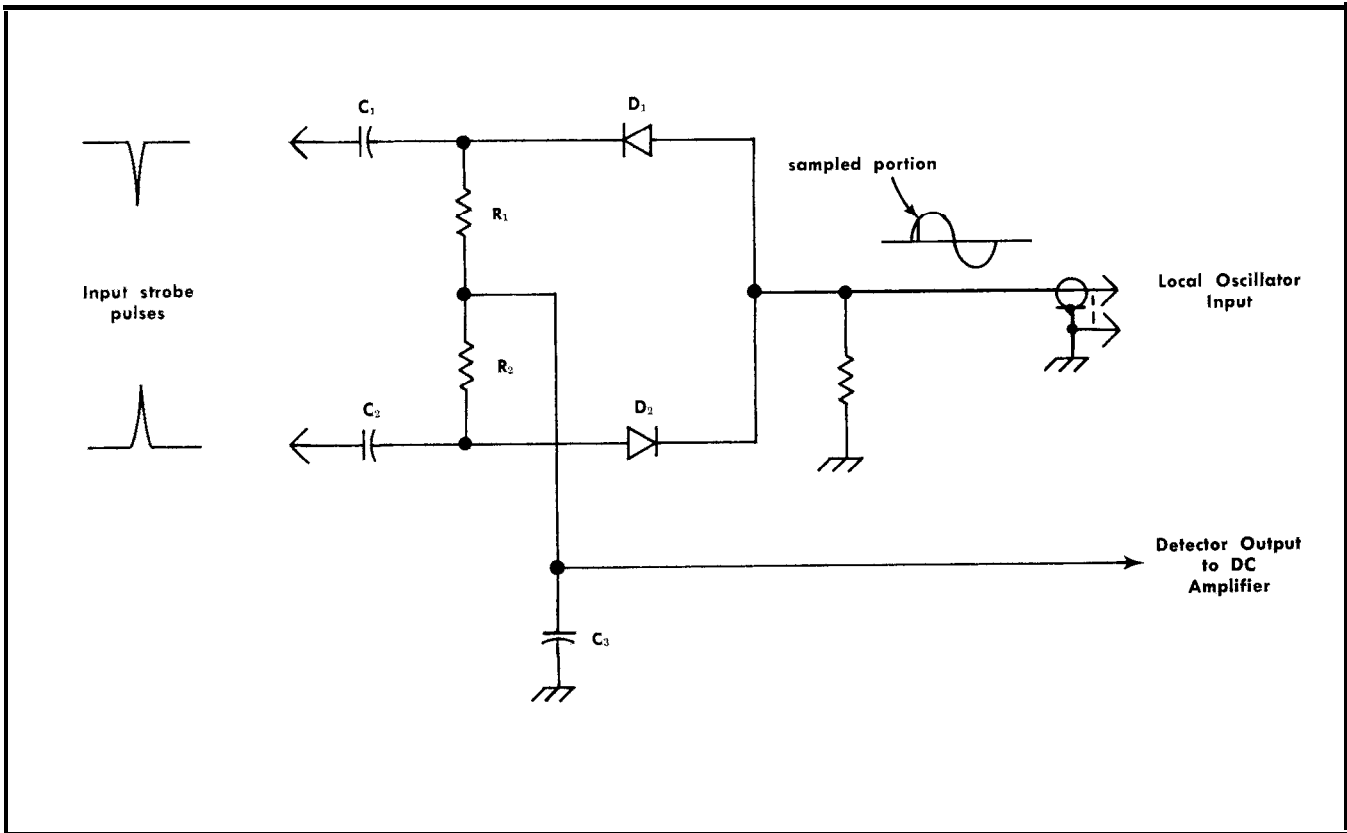

Fig. 3-4. Simplified phase detector circuit.

resultant feedback signal from a frequency to voltage converter and ramp generator. Any differential between the two signals is a voltage output that controls the bias on frequency-determining capacitance diode D314. D314 is part of the swept oscillator circuit which shifts the swept oscillator frequency by an amount proportional to the signal output from the comparator.

Q240 is the constant current source for the sweep comparator. About 3.4 mA of current through the comparator is set by the bias of Q240. Output DC level at the collector of Q230 is set by the IF Center Freq Range adjustments in the collector circuit of Q260.

**Sweep Oscillator.** The oscillator frequency is primarily a function of the L (L314) and C (diode D314 in series with blocking capacitor C314) in the collector circuit of Q310. Capacitance of diode D314 is varied by the signal from comparator Q230-Q220. An increase in back bias decreases the capacitance of the diode and increases the frequency of the swept oscillator. Capacitance change of the diode is not proportional to the voltage ramp, but high gain in the discriminator feedback loop to the comparator reduce this non-linearity. At maximum dispersion, the oscillator sweeps from 225 MHz to 325 MHz.

Output signal from the oscillator is tapped across the partial winding of L314 and capacitively coupled to transformers T330 and T331. The transformers step the voltage up about 2:1 and converts the single-ended signal to a balanced push-pull drive signal for the output amplifier Q340 and Q350.

Fig. 3-6 is a simplified drawing of the transformer circuit. The oscillator is the signal source or generator which supplies the signal voltage (e). The input windings of T330 and T331 are connected in series; therefore, the voltage across each winding equals  $e/2$  (assuming an ideal transformer). The polarity of the signal at a particular instant of time is shown in Fig. 3-6. This voltage, across the input windings, produces an equal voltage ( $e/2$ ) across the output windings with the polarity as indicated in Fig. 3-6.

The generator, or source, is in series with the output winding for T331, therefore, the voltage of the output with reference to point A equals  $3e/2$ . This voltage adds to the voltage output of T330 to provide a total output signal of  $4e/2$  or  $2e$ .

If the reference point is changed to the common side of the input windings of T330 and T331 (shown as a phantom ground on the simplified drawing) the impedance looking into the output terminals of the transformers is balanced,

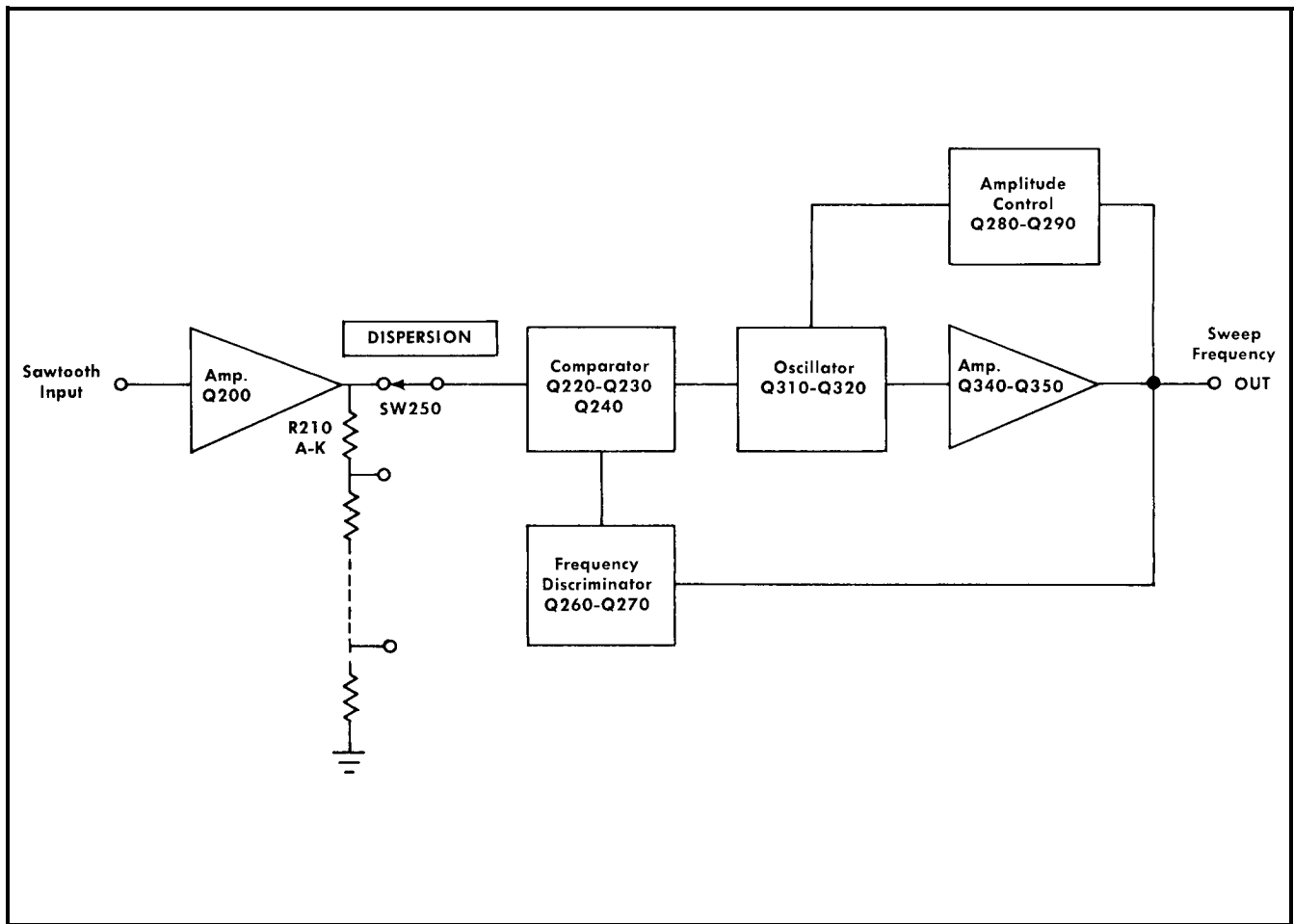

Fig. 3-5. Block diagram of sweeper circuits.

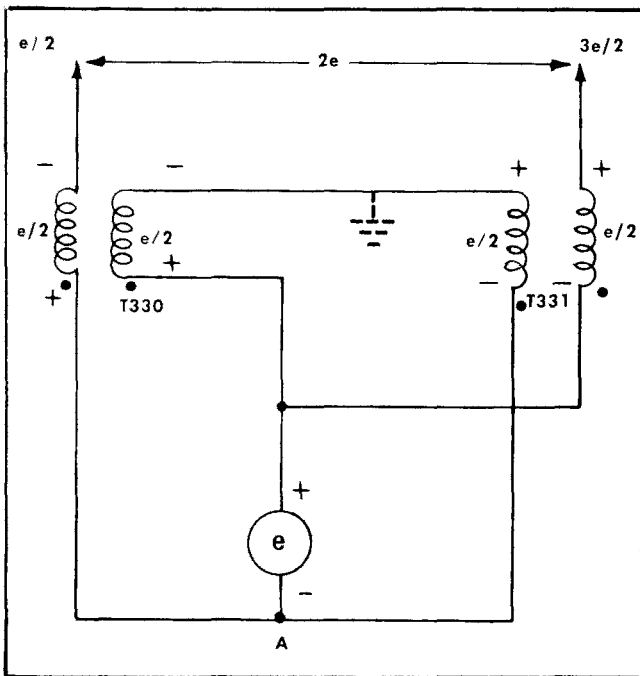

Fig. 3-6. Simplified diagram of the transformer (T330-T331) circuit from the swept oscillator to the push-pull amplifier Q340-Q350.

so the drive signal to the amplifiers is a balanced push-pull signal.

Transformers T343 and T354 in the collector circuit of Q340 and Q350 provide a 4:1 impedance transformation from the collectors of the transistors to the output transformer T347.

Transformer T347 converts the push-pull signal to a single-ended output signal. Push-pull amplification, plus filtering through the low pass filter circuit of L358-C358 and L348-C348 reduces the harmonic content in the swept frequency output signal.

Diode D334 in the base voltage divider circuit provides the temperature compensation for transistors Q340-Q350.

The single-ended output signal is coupled through a 2:1 impedance transformer T363, to the mixer in the Wide Band IF. The output signal is also applied, through two feedback loops, to frequency and amplitude control circuits.

**Frequency Discriminator.** Two frequency discriminators for each position of the DISPERSION RANGE selector SW365 provide an output voltage signal to the frequency discriminator comparator Q260. The output voltage from the comparator is a ramp voltage that is proportional to the sweep oscillator frequency. It is applied to one side of the comparator Q230-Q220.

The MHz/Div discriminator consists of two matched diodes, D373 and D376, at the input ends of two transmission lines. The transmission lines are  $\frac{1}{4}$  wavelength long at the center frequency (275 MHz). One line is open ended and appears capacitive, the other line is shorted and appears inductive, at the center frequency. As the input frequency to the discriminator increases, the transmission line input impedance nears the characteristics of a  $\frac{1}{4}$  wavelength line. The shorted

transmission line input impedance increases, the open ended line input impedance decreases. This produces proportionate changes to the output signal from the diodes. Signal output from diode D376 becomes more negative, and signal output from D373 becomes less negative. This push-pull drive is applied to the comparator Q260 and converted to a single ended output signal for the sweep comparator.

Thermal balance is achieved by balancing the current differential through both sections of the transistor. The common emitters are connected to a constant current source Q270. Current (approximately 3 mA) is established by the voltage drop across the emitter resistance R274.

The IF CENTER FREQ (R256) and the FINE (R259) controls sum in a DC voltage with the differential signal from the comparator to allow positioning of the IF center frequency (200 MHz or a frequency close to 200 MHz) to the center of the horizontal sweep.

The amplitude of the ramp signal to the sweep comparator is a function of the DISPERSION RANGE switch SW210 and the DISPERSION selector SW365 setting. This amplitude determines the frequency deviation swing of the sweep oscillator band.

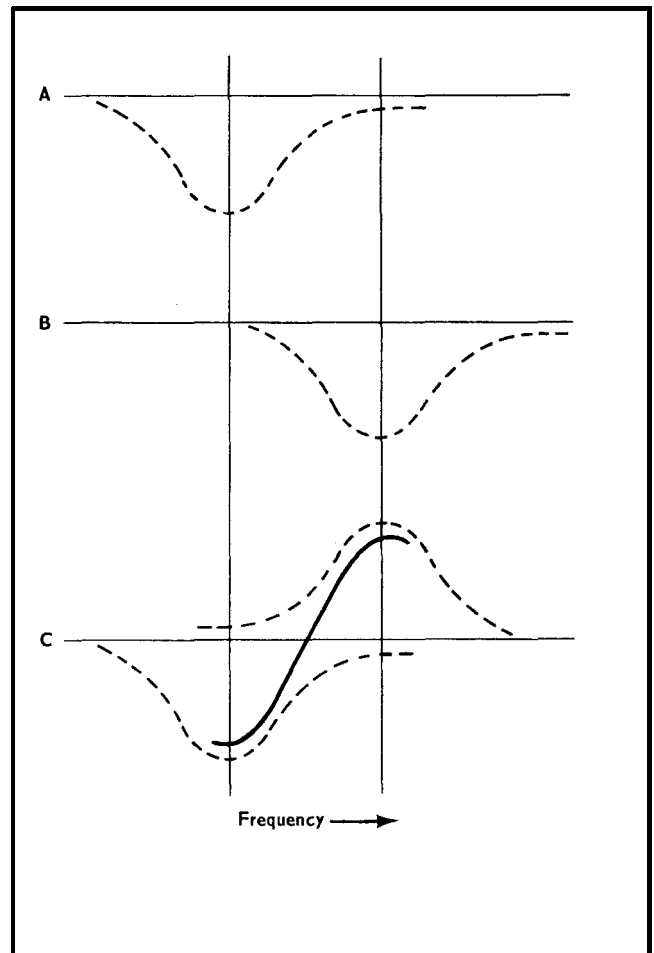

Fig. 3-7. Frequency vs Voltage curves for kHz/DIV discriminator circuit.

The discriminator for the kHz/DIV position of the DISPERSION RANGE switch consists of tuned circuits which operate much like the tuned transmission lines for the MHz/div discriminator. The parallel circuit L384-C384 is tuned slightly below the center frequency, and the circuit L385-C385 is tuned above the center of the sweep oscillator frequency. The output of the detectors is shown in Fig. 3-7. When the detector output is applied to the comparator, a voltage versus frequency curve similar to Fig. 3-7C is the resultant output. The circuit operates over the linear portion of the curve. The kHz/div Cal adjustment R368 calibrates this range.

Diodes D277 and D279 isolate the narrow band discriminator tuned circuit when the Type 491 is operating in the MHz/DIV dispersion range. They prevent parasitic oscillation due to circuit coupling between the wide band and narrow band discriminators. The diodes are forward biased when the DISPERSION RANGE switch is in the MHz/DIV position and the current through the diodes lowers or spoils the Q of the tuned discriminator circuit. When the DISPERSION RANGE switch is in the kHz/DIV position, the diodes are backbiased and disconnected from the low dispersion discriminator circuit.

**Amplitude Comparator.** Uniform sensitivity and linearity over the dispersion range is maintained by controlling or regulating the oscillator output amplitude. This is accomplished by the RF amplitude comparator circuit, Q290 and Q280. The RF output signal is detected by diode D361 and applied through diode D362 to the base of Q280. This rectified RF signal on the base of Q280 is compared against a reference voltage set by the RF Ampl adjustment R290. The differential output signal is fed back as a voltage to control the forward bias of Q320. Q320 is the current source for the oscillator circuit. Amplitude changes in the oscillator output are fed back as correction signals to the current regulator to regulate oscillator current or output power.

To summarize the sequence of operation for the sweeper circuit, assume the output from the sweep comparator Q220-Q230 is a positive-going ramp. This voltage ramp increases the bias on the capacitance diode and decreases the circuit capacitance so the oscillator output frequency will increase. This increase in output frequency is fed back to the discriminator, and detected as an increasing negative voltage output from D376 (assuming the DISPERSION RANGE switch is in the position shown in the schematic diagram) and a decreasing negative voltage from D373. The differential output from comparator Q260 is a positive-going ramp to the base of Q230, where it is compared against the input ramp on the base of Q220. The differential signal output from the sweep comparator, synchronizes the sweep oscillator with the horizontal sweep generator sawtooth signal and the dispersion is a function of the DISPERSION RANGE and DISPERSION selector positions.

DISPERSION RANGE BAL adjustment R234 provides IF center frequency balance adjustment between the MHz/Div and kHz/Div dispersion positions. Center Freq Range adjustment (R251) and CAL (R250) calibrate the frequency range of the IF CENTER FREQ control over the IF center frequency.

### Wide Band (1 50-250 MHz) Amplifier and Second Mixer

The wide band amplifier contains an input 150-250 MHz band-pass filter, two amplification stages and a mixer

amplifier with its output tuned to 75 MHz. Gain through the amplifier is approximately 20 dB.

The wide band response from the RF section is applied through a 150-250 MHz band-pass filter to the input amplifier Q120. The band-pass filter is a combination constant-k type filter, modified with m-derived input and output sections to provide a constant 500 input and output impedance through the pass band. Series-tuned circuits L101-C101 and L107-C107, are tuned to the low end of the band; L102-C102 and L108-C108 primarily control the high frequency response characteristic of the filter. All of the adjustments interact and are adjusted for optimum response flatness over the pass band.

Toroid transformers T120, T125 and T134 provide the wide band characteristics for the input and output coupling. L124-C124 form a 75 MHz trap to provide additional attenuation (approximately 60 dB) to any 75 MHz signal that may push through the filters.

C137 in the emitter and L134 in the collector of Q130 are peaking adjustments and adjusted for optimum flatness of the IF response. C137 compensates for the transistor rolloff toward the high end of the band; however, because of the low Q in the collector circuit; due to R134 and circuit loading, the overall effect of both adjustments (L134 and C137) is seen as a bandpass response adjustment.

The output from Q130 is applied through transformer T134 to the base of mixer amplifier Q140. The swept oscillator output is coupled to the emitter of Q140. The collector output load (L144 and C143) is tuned to 75 MHz so the difference frequency of 75 MHz is coupled through the 65 MHz trap to the attenuator circuit as the 2nd IF frequency. The 65 MHz trap (L147-C147) attenuates or rejects 65 MHz signal component from feeding through to mix with the 70 MHz oscillator. Any 65 MHz signal would mix with 70 MHz to generate a 5 MHz signal for the narrow band IF amplifier and would appear as an undesirable spurious response on the output display.

### IF Attenuator

The IF attenuator is a six section network that provides a total signal attenuation of 51 dB. The input and output impedances to the attenuator are maintained at a constant 50  $\Omega$  regardless of the IF ATTENUATOR switch setting. Input and output filter sections (C151-L151-C152 and C187-L188-C188) at the input and output of the attenuator form a low pass filter to prevent high frequency signals from feeding into the 75 MHz amplifier.

### Narrow Band IF Amplifier

This circuit contains two stages of 75 MHz IF amplification, a stable 70 MHz oscillator, a mixer amplifier with its output tuned to 5 MHz and a stage of amplification for the 5 MHz IF frequency,

Input to the amplifier is AC coupled from the IF attenuator to the base of Q420. The 75 MHz IF amplifiers are Q420 and Q430. The IF transformers are tuned to the IF frequency by adjusting the capacitance of C425 and C435. Gain of the amplifier is varied by changing the forward bias of Q420, which then sets the bias of Q430 through the DC return of



its base to emitter Q420. A feedback winding on T424, to the base of Q420, provides the neutralization for the collector-to-base capacitance.

The 75 MHz IF and the output from a crystal controlled 70 MHz oscillator Q440, are applied to the mixer amplifier Q450. The collector output circuit of Q450 is T454, which

is tuned to 5 MHz and couples the signal to the 5 MHz IF amplifier Q460. Diode D454 in the collector load of Q450 improves the overload characteristics of the amplifier. Output of the 5 MHz IF signal is applied through an insulated connector J470 to the input of the variable resolution amplifier.

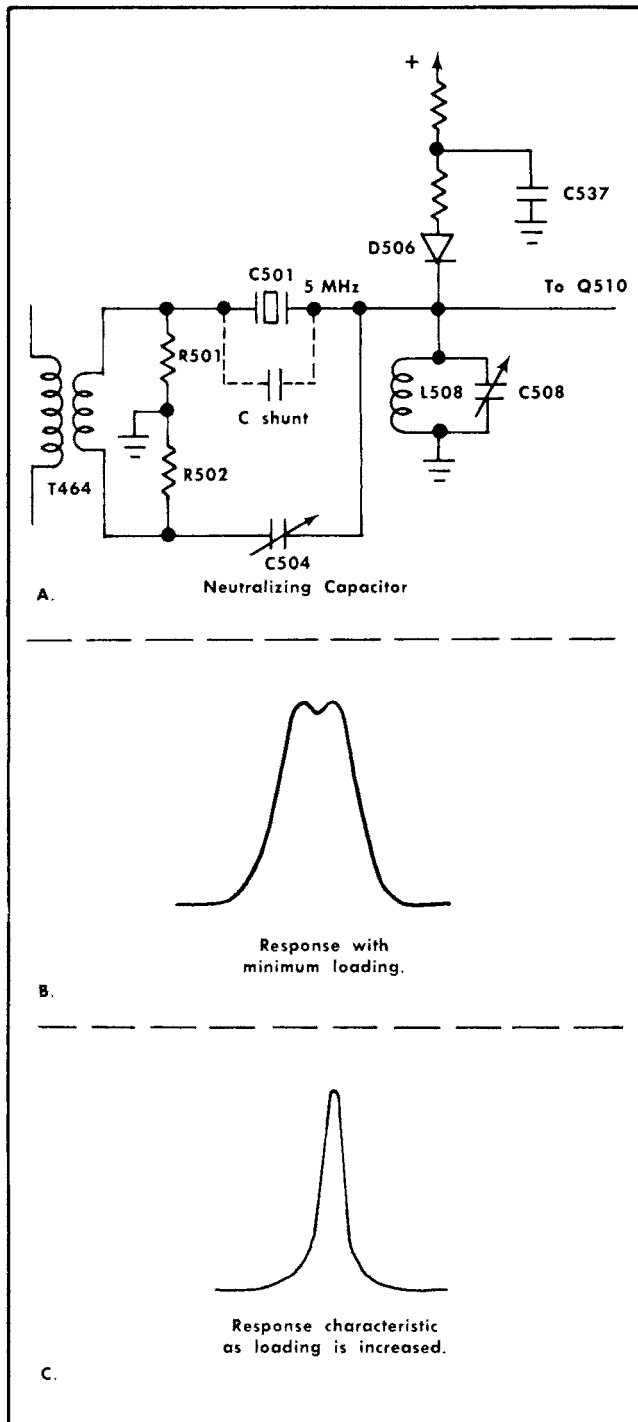

Fig. 3-8. Crystal variable resolution filter.

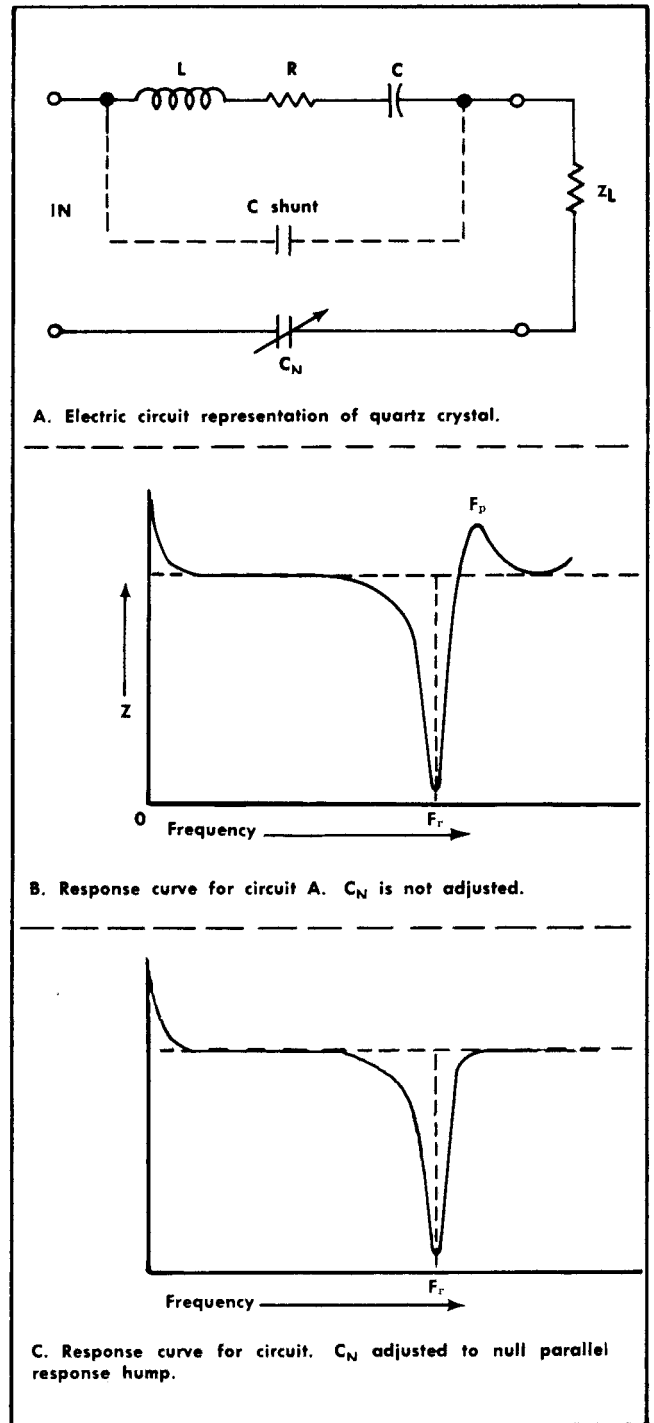

Fig. 3-9. Crystal filter, equivalent circuit and impedance response curves.

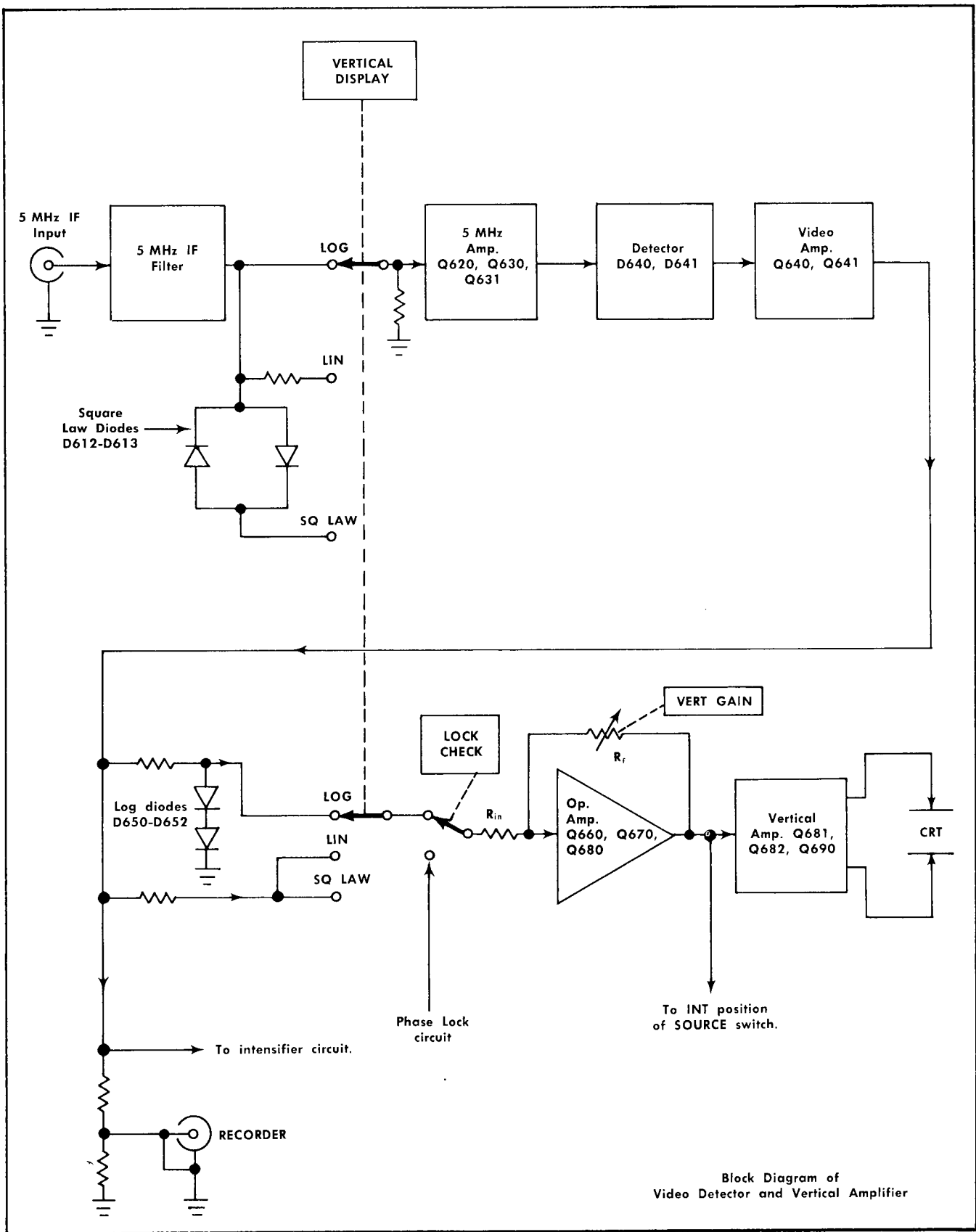

Fig. 3-10. Block diagram of the video detector and vertical amplifier.

## Variable Resolution Amplifier

The variable resolution amplifier is designed to vary the bandwidth of the 5 MHz IF from approximately 100 kHz to less than 1 kHz. Bandwidth of the circuit is a function of the output load for a crystal filter network. By varying the output load a variable resolution bandwidth is obtained.

The signal input to the variable filter circuit is insulated from chassis ground and connects across R501-R502. Crystal Y501 is a 5 MHz crystal, connected in series between the input and the parallel resonant circuit L508-C508. Bandwidth or resolution of the circuit is dependent on the characteristic response of the crystal at its series resonant frequency and the Q of the parallel resonant circuit L508-C508.

Fig. 3-8 illustrates the impedance response versus frequency curve of a quartz crystal. Capacitor C504 neutralizes the stray shunt capacitance around the crystal so the response of the crystal is equivalent to a series tuned circuit with a very narrow band-pass<sup>1</sup>; see Fig. 3-9.

The bandwidth of the filter network is a function of the crystal output load, which is primarily the parallel resonant circuit; therefore, bandwidth becomes a function of the Q for the resonant circuit. The Q of the output load circuit for the crystal is varied by changing the bias of diodes D506, which changes the shunt loading across the parallel-tuned circuit.

As the forward bias of D506 is increased, the Q of the parallel resonant circuit decreases and the response characteristic of the crystal becomes the dominant factor in determining the bandwidth of the filter network. The crystal response is very narrow, so the display resolution is increased as the diode forward bias increases.

SW550, the RESOLUTION selector, is coupled to the DISPERSION selector and when coupled, provides normal resolution for each position of the DISPERSION selector. However, by pulling the control knob, the RESOLUTION selector is uncoupled and any desired resolution within the range of the control CAN be obtained for a given DISPERSION selector setting.

The 100 MHz Resol Cal adjustment R543, adjusts the resolution bandwidth to approximately 100 kHz with the RESOLUTION control at the fully clockwise position, and to 60 kHz at the -6dB point in the next position. The other RESOLUTION control positions are not calibrated. However, the bandwidth at each step provides adequate resolution for most displays.

Emitter followers Q510-Q520 isolate the high impedance of the filter network from the relatively low output impedance, thus minimizing circuit loading on the filter network. Q530 is a grounded-emitter operational amplifier with a relatively low output impedance to provide the signal amplitude required to drive the Log and Sq Law circuits.

<sup>1</sup>(Ref. F. Langford-Smith RAC Radiotron Designer's Handbook; 4th edition.)

## Video Detector and Vertical Amplifier (Fig. 3-10)

The 5 MHz IF response from the variable resolution amplifier is applied to a band-pass filter circuit to shape the response and attenuate spurious signals. VERTICAL DISPLAY switch SW600 selects one of three possible displays; LOG, LIN and SQ LAW.

The LOG position applies the signal directly to the base of the amplifier Q620. This direct coupling, with no signal attenuation, provides the full dynamic range required for the LOG diode circuit at the output of the video amplifier and a logarithmic display.

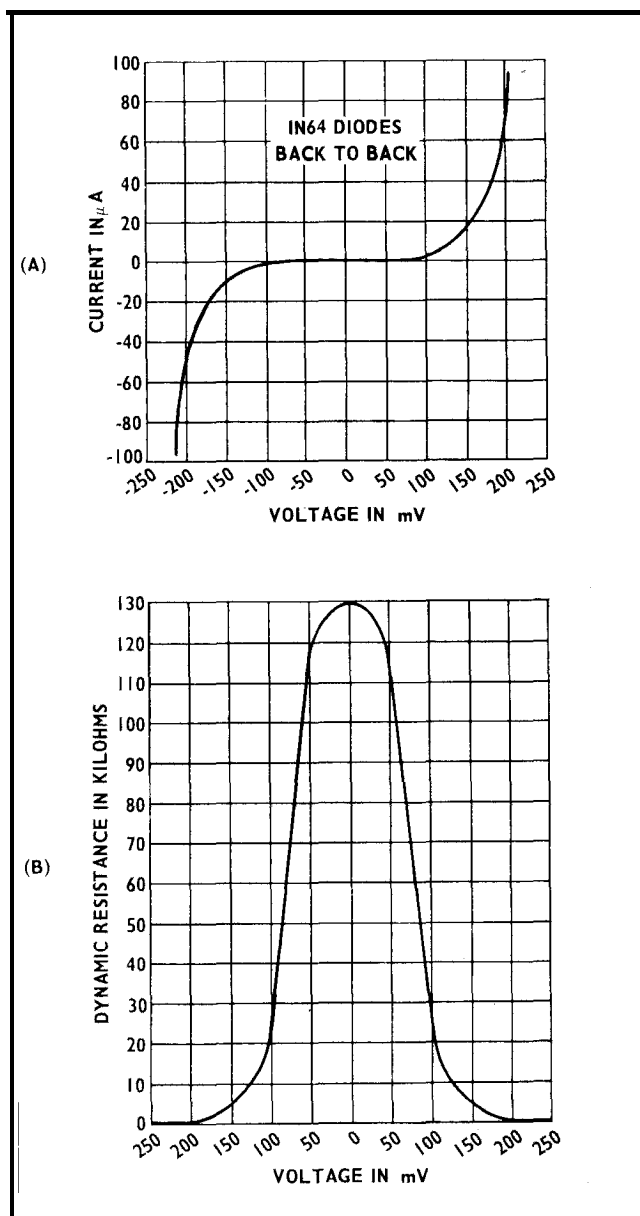

Fig. 3-11. Characteristic curves for 1N64 diodes; (A) voltage vs current; (B) voltage vs dynamic resistance.

The input signal is attenuated through R617 and the input impedance to Q620, so that an approximate 5 division display in the LIN position will provide approximately the same signal amplitude when the switch is changed to either of the other two positions.

In the SQ LAW position the signal is applied through two germanium diodes, D612-D613, to the base of Q620. The diodes are connected back to back to form a square-law voltage divider. Signal voltage to the amplifier Q620 in the SQ LAW mode becomes a function of the diode's dynamic resistance as shown in Fig. 3-11.

Note that diode resistance exceeds  $100\text{ k}\Omega$  for very low (mV) input signals. The divider ratio is approximately 200:1 so 0.5% of the signal will be applied to Q620. With a 150 mV signal the dynamic resistance of the diode decreases to approximately  $5\text{ k}\Omega$ , so approximately 10% of the signal will be applied to Q620. The circuit will normally have about 70 mV signal for full screen display so the diodes operate along the steep portion of the dynamic resistance curve.

This non-linear dynamic resistance of the divider produces a display which emphasizes small signal level differences between signals. The vertical response for the SQ LAW display is approximately proportional to the signal power.

Q620 is a high gain amplifier driving the complementary amplifier Q630-Q631. The complementary amplifier provides the drive for the step-up transformer T640. This provides the voltage gain required to drive the LIN detector, the log circuit, the recorder and the intensifier circuit. The signal to the RECORDER output connector is a linear signal in the LIN and LOG positions of the VERTICAL DISPLAY switch, and square law in the SQ LAW position.

The video detector diodes D640 and D641 are connected as a voltage doubler for maximum efficiency. The output video signal is then amplified through the emitter followers Q640 and Q641 and applied through the VERTICAL DISPLAY switch SW600 to the vertical amplifier. Q641 is long-tailed through R657 to the -10 V supply to provide a constant DC output level to drive the vertical amplifier, the baseline suppress circuit and the RECORDER output connector. This provides minimum baseline shift when the VERTICAL DISPLAY selector is switched between positions.

The logarithmic circuit consisting of R650, R651, R653, D650 and D652 provides a logarithmic display when the VERTICAL DISPLAY switch is in the LOG position.

Low amplitude video signal voltages appear across D650 with little or no attenuation. As the amplitude increases, the current through the diode becomes an exponential function of the voltage across the diode, R650 becomes the current source for the diode, so the voltage out becomes a logarithmic function. As the signal amplitude increases the diode current approaches the linear region of the voltage-current characteristic curve; however, this current through R653 develops sufficient voltage across D652 to turn this diode on and the two diodes operate in series to extend the logarithmic range of the circuit.

**Vertical Amplifier.** The vertical amplifier consists of an operational amplifier driving a paraphase output amplifier. The operational amplifier consists of the grounded base amplifier Q660, driving the emitter follower Q670 and the inverter amplifier Q680. Output signal from the collector of Q680 is fed back to the input of the amplifier, through

R672 (Vert Gain adjustment) in series with R671, to the emitter of Q660. Gain of the amplifier is a function of the ratio  $R_1/R_{in}$ .  $R_1$  is controlled by the Vert Gain adjustment.

POSITION control R665, sets the input DC level to the operational amplifier which is reflected as a DC shift in the output level to the vertical output amplifiers. Diodes D670 and D671 do not normally conduct. They limit the overdrive and speed up the recovery of the amplifier.

The low impedance signal output from the operational amplifier drives the vertical amplifier output stage. The output amplifier is connected as a paraphase amplifier to convert the single-ended input signal to a push-pull drive for the vertical deflection plates of the CRT. The common emitters of the output amplifier are connected to a constant current source Q690, which supplies approximately 2.5 mA to each output side of the amplifier (or 5 MA total).

## Trigger Generator, Sweep Generator and Horizontal Amplifier

The sweep generator will free run or it may be triggered by the internal video signal, the line frequency or an externally applied triggering signal.

Sweep rates in a 1-2-5 sequence may be selected for 0.5 s/div to  $10\text{ }\mu\text{s/div}$ . The sweep voltage generated by the sweep generator is amplified by the horizontal amplifier and applied as a push-pull sawtooth to the horizontal deflection plates of the CRT.

If the sweep generator is triggered, the selected trigger signal is amplified and shaped by a trigger amplifier then applied to the trigger generator. Trigger signal level and slope can be adjusted and selected.

The trigger pulse from the trigger generator switches a sweep gating multivibrator to generate the unblinking gate for the CRT during sweep time and initiates the operation of the sweep generating circuit.

The sweep generator supplies a linear and timed ramp signal to the horizontal amplifier plus a feed-back signal to the trigger generator. This feed-back signal locks out or holds off the trigger signals to the sweep gating multivibrator until the sweep has run and the circuit is ready again to be triggered.

**Trigger Generator.** The selected trigger signals from the SOURCE switch are AC coupled through C701 to an operational amplifier Q700, Q710 and Q720. The output of this operational amplifier is a low impedance signal that drives one side of a comparator amplifier Q730-Q731.

The input DC level to the operational amplifier is set by the trigger LEVEL control R702, and the Trig Level Center adjustment R724. This input DC level to the operational amplifier also governs the output DC level of the amplifier which is the input level to the comparator Q730-Q731,

One side of the comparator is referenced through the SLOPE switch SW720 to ground, while the other side is connected through the SLOPE switch to the output of the operational amplifier. The Trigger LEVEL control adjust the DC level, on the signal side of the comparator, to a voltage potential above or below ground. The input trigger signal must overcome this unbalance to trigger the trigger generator

circuit. Triggering becomes a function of the trigger signal amplitude and the slope of the trigger signal.

The Trig Level Centering R724 is adjusted with the Trigger LEVEL control set to zero volts. It is adjusted so a low amplitude input signal will trigger the trigger generator with the SLOPE switch in either the + or - position.

The trigger generator consists of the comparator Q730-Q731, the tunnel diode D737 and the amplifier Q740. In the quiescent state, with the trigger generator ready to be triggered, the comparator is unbalanced so Q730 is conducting most of the current. The current of Q731 sets the tunnel diode between its low operating and threshold state.

If the current through Q731 is increased by the application of a trigger signal (negative-going signal on the base of C2730 or positive-going signal on the base of Q731) the tunnel diode will shift to its high state. When the TD shifts to its high state, a fast-rise pulse is generated at the base of the amplifier Q740. This generated trigger pulse is amplified, inverted and applied as a positive-going pulse to the sweep gating multivibrator Q750-Q751. The output waveform of the multi vibrator is the sweep gate to the sweep circuits and the CRT unblanking signal.

**Sweep Gating Multivibrator.** The positive-going input pulse from the collector of Q740 turns Q750 on and flips the multivibrator. This applies a negative-going gate to the emitter follower Q752 which provides the unblinking pulse for the CRT blanking plates and the sweep gate signal to the emitters of the gated comparator Q770-Q771. The sweep gating multivibrator is a bistable oscillator so it will remain in this state until a signal is applied to the circuit to switch the multivibrator back to its pretriggered state.

The sweep gate signal steps the emitter potential of the gated comparator Q770-Q771 from approximately 1 volt to 0 volt. The DC level on the base of Q771 is approximately 300 mV (set by the voltage divider R779 and R778). The base voltage of Q770 is approximately 1.3 volts (set by the 10:1 voltage divider R770 and R771). Both sides of the comparator are therefore back biased when the negative-going gate is applied to the emitters. The collector of Q771 steps down abruptly, gate diode D781 disconnects and the Miller runup circuit action is initiated.

**Sweep Generator.** When diode D781 disconnects, collector current from Q771 is interrupted so the base of Q790 starts toward the -10 volt supply.

The Miller runup circuit is essentially a high gain amplifier employing negative feedback. The positive-going voltage at the collector of Q791 is fed back through runup emitter follower Q800 and coupled through the timing capacitor C785 to the base of Q790. This feedback voltage opposes the tendency for the base to swing negative. Because the gain of the amplifier Q790-Q791 is high, a very linear rate of charge is maintained on the timing capacitor C785. Timing current through R785 almost equals the charging current of C785 so the base of Q790 moves only a very small amount during run-up.

The linear voltage rise at the emitter of Q800 rises to approximately 7.5 volts (set by the Sweep Length adjustment R759) and pulls up the base of Q751 to its forward bias state. At this point the gating multivibrator is flipped to its pretriggered state. The emitter of Q752 now steps up to approximately +9 volts.

When the emitter voltage of Q752 steps up, Q771 is turned on hard. This applies forward bias to the disconnect diode, and timing current plus extra base current is now supplied by Q771. The Miller circuit now starts to run down and will continue to run down until diode D770 is forward biased. This occurs when the emitter potential is approximately 0.6 volts more negative than the 1.3 volt potential on the base of Q770. This turns Q770 on. It now shares part of the available current. The rundown of the Miller circuit levels off and a condition of equilibrium is maintained. The output voltage level of the Miller circuit remains near 0 V until the next gate is applied to the gate comparator, when it again runs up to generate another sweep ramp.

Diode D782 conducts if the positive voltage excursion on the base of Q790 should be excessive. This prevents the Miller circuit from hanging up.

**Holdoff Circuit.** When the sweep gate is applied to the emitters of the gated comparator, the collector of Q770 steps down from approximately 0 volts to -1.4 volts (drop across D767 and D768). The negative-going gate to the base of Q761 is amplified and applied to Q760 as a positive-going gate. This turns Q706 on hard. The resultant current demand of Q760 through R741 pulls the emitter of the trigger amplifier Q740 down far enough to cut Q740 off. No trigger signal can now get through from the trigger generator to the sweep gating multivibrator.

When the sweep gating multivibrator is flipped to its pretriggered state by the sweep ramp on the base of Q751, the positive-going gate at the emitter of Q752 is not sufficient to turn Q770 on. The sweep ramp must run down to approximately 0.6 volts to turn D770 on. After a time delay period, established by the RC feedback network (C761 and R762 between the collector and base of Q760), the collector current of Q760 will decrease. This increases the forward bias of Q740 to the point where it again conducts and an applied trigger signal to the amplifier will now go through the amplifier to trigger the sweep gate multivibrator and initiate another sweep.

Sweep rate is a function of the timing resistors R785 and timing capacitors C785. R786 is the VARIABLE control which provides an approximate 2.5 times sweep rate change between the TIME/DIV selector (SW785) positions.

**Horizontal Amplifier.** The sawtooth voltage at the emitter of Q800 drives the paraphase amplifier Q810-Q820 which converts the single-ended sweep from the sweep generator to a push-pull drive signal for the horizontal deflection plates. The paraphase output amplifier is long-tailed to the constant current source Q830 and Q831. Horizontal gain is provided by the GAIN adjustment R813. Horizontal trace positioning is provided by the POSITION control R823 which shifts the DC output level to the horizontal deflection plates.

## CRT and Blanking Circuit

This circuit contains the high voltage generating and regulating circuits for the accelerating potentials on the CRT, plus an unblinking circuit, and a baseline suppressed or intensifier circuit.

**High Voltage Circuit.** The high voltage oscillator Q1003 drives the primary windings of the high voltage transformer T1010. The high voltage rectifier circuit, containing D1014

and D1016, is configured as a voltage doubler. The circuit provides approximately -3700 volts for the cathode of the CRT and is the reference voltage for the half-wave rectifier D1020, which develops an additional -150 volts (approximately) for the CRT grid to cathode bias.

A sample of the high voltage is taken from the voltage divider circuit and applied to an error sensing and amplifier circuit, Q1000, Q1001 and Q1002. This circuit controls the current through the high voltage oscillator to regulate the high voltage output.

Q1003, with the primary windings of T1010 plus the distributed circuit capacitance, comprise the high voltage oscillator. Q1002, in shunt with the emitter-base winding of the oscillator, regulates the oscillator current.

Q1000 compares a sample of the high voltage with the -10 volt regulated supply. The error voltage is amplified through the complementary amplifier and regulator Q1001 and Q1002.

The emitter of Q1002 or output of the regulator is connected through R1009 to the +10 volt supply. This provides the initial forward bias to the base of Q1003. Positive feedback from the collector winding to the base-emitter winding causes the circuit to oscillate. Frequency of oscillation is dependent on transformer winding capacitance, including reflected reactance of the secondary windings. Frequency of oscillation is approximately 50 kHz.

The voltages supplied by the secondary windings of T1010 are: +175 V for the +150 volt regulator circuit in the low voltage power supply; -3700 V for the CRT cathode; 6.3 VAC for the CRT heater, and grid bias voltage for the CRT. All of these voltages are regulated by the regulator circuit. The amplitude of the oscillator output signal, or the transformer primary voltage, is dependent on drive voltage to the base of Q1003. The DC base voltage of Q1003 is set by the base voltage of Q1002.

The HV Adjust R1001 sets the forward bias for the amplifier Q1000. This sets the current through Q1001 and Q1002. For example: A decrease in the high voltage load (current demand decreases) will decrease the forward bias of Q1000 and a positive-going signal is applied to the base of Q1001. This decreases the DC voltage at the base of Q1003. The feedback therefore decreases the oscillator output and the output high voltage will remain constant. Ripple reduction is a factor of the amplifier gain.

R1032 (Intensity Range) and R1033 (INTENSITY level control) provide a range from 0 to approximately 100 volts bias for the CRT to vary the CRT beam current. FOCUS R1028 and ASTIGMATISM R1038 controls provide a variable positive (with respect to the cathode) control voltage to the focusing anode and astigmatism grid. These two controls are normally adjusted in sequence for optimum beam focus over the CRT graticule area.

**Trace Rotation.** The Trace Rotation control provides means to align the horizontal trace on the CRT with the graticule lines. The Trace Rotation adjustment R1035 varies the magnetic field about the coil around the CRT. It will rotate the horizontal beam approximately +3°.

**Blanking Circuit.** Blanking in this CRT is dependent on the voltage difference between the deflection blanking plates.

When the voltage difference between the plates is significant, few electrons strike the phosphor and the CRT is blanked.

The voltage on one deflection blanking plate (pin 9) is fixed at approximately +80 volts by the voltage divider R1040-R1042. The voltage on the other plate (pin 7) is dependent on the output level of the operational amplifier Q1080 and Q1081.

The quiescent level (no-trace period) of Q1080 collector is about +10 V and the electron stream from the cathode of the CRT is deflected to the side because of the voltage difference between the plates. No beam or trace is visible on the screen. During sweep time, a negative unblinking pulse is applied to the base of Q1081. This raises the operational amplifier DC output level to the voltage level on the other blanking plate so the electron stream can now pass through to the CRT screen. The beam or trace is now visible.

**Intensifier Circuit.** Signal intensification or hose line suppression provides increased contrast between spectrum signals and the baseline of the display.

The video signal is applied through diodes D1050 and D1051 to one side of a comparator amplifier Q1050 and Q1051. The input video signal is compared against a DC level set by the INTENSIFIER control R1013 and the resultant differential output is applied across the base-emitter junction of Q1070.

The positive-going input video from the detector circuit produces an output voltage from the comparator amplifier which will decrease the forward bias of Q1070. This produces a negative-going voltage at the collector of Q1070. This voltage is applied through the CONTRAST control R1075 to the input of the operational amplifier Q1081 and Q1080. A negative-going signal from the intensifier circuit adds to the unblinking voltage signal and modulates the CRT blanking plates so that the CRT beam is intensity modulated (Z axis modulation).

Diode D1073 provides a reference voltage to ground for the collector of Q1070. With no signal input, the collector potential of Q1070 is approximately +10 volts. The INTENSIFIER control sets the quiescent current through the intensifier circuit, which sets the DC level at which intensification begins. CONTRAST control R1075 adjusts the amplitude of the modulating signal to the unblinking circuit. This determines the contrast between the suppressed baseline and the video signal.

## Low Voltage Power Supply

The low voltage power supply in the Type 491 (see Power Supply schematic diagram) consists of three inter-related supplies that operate together as a system. This system delivers regulated and filtered voltages of -10, +10 and +150 volts. A common power transformer T900 supplies the input power to each of the supplies. The input circuit to the power transformer primary can be altered so the Type 491 will operate through a voltage range from 90 VAC to 136 VAC. A second plug-in connector switches the transformer primary winding from 115 V nominal to 230 V nominal line voltage by connecting the windings in series for 230 VAC operation or in parallel for 115 VAC operation. The Operating section of the manual describes connector switch positions for each voltage range. Unless otherwise specified, the Type 491 is shipped with T900 connected for 115 VAC input.

Overload protection is provided by fuse F900 and F902. Thermal cutout TK902 in the primary circuit of T900 opens the transformer primary circuit if the temperature inside the analyzer rises above a safe level. TK902 resets automatically when the temperature returns to normal.

**-10 Volt Supply.** This is the reference voltage for the other voltage supplies and the comparator circuits in the Type 491. Reference voltage for the -10 volt supply is set by zener diode D964, to approximately -0.9 V on one side of a comparator Q960-Q961. The voltage to the other half of the comparator is obtained from the voltage divider R967, R968 (-10 volts), R969 and diodes D967-D968. When R968 is properly adjusted the output voltage from the regulator is exactly -10 volts.

Error voltage signal is sensed by the comparator Q960-Q961 and applied as a correction signal through the complementary amplifier Q952-Q951 to the base of the regulator Q960. For example, an increased current demand by the -10 volt supply load would tend to develop a negative-going error signal on the error side of the comparator. This produces a positive-going correction signal to the base of Q950 and the extra current demand of the load is supplied.

The regulator circuit can never completely compensate for changes in output voltage, because there must be an error input for the circuit to operate. However, any error in the output is reduced by a factor equal to the loop gain of the regulator circuit.

**+10 Volt Supply and Regulator.** Error sensing for the +10 volt supply is accomplished by the amplifier Q930. A sample of the +10 volt supply is applied from the voltage divider, R934-R935 in series with the regulator Q920, to the base of Q930. This voltage sample is compared with the -10 volt emitter reference voltage. D932 provides thermal compensation for Q930.

The amplified error signal from Q930 is emitter-coupled through Q922 to the base of the regulator Q920. Q921 is connected in cascade with Q922 and isolates the collector of Q922 from the rectifier output. This reduces the amount of the power supply ripple couple into the regulator circuit.

The +10 volt supply provides power for the POWER indicating light B948. Current is also supplied from the +10 V unregulated supply, through transistor Q940 to the scale illumination lights. The SCALE ILLUM control R940 sets the current through the illumination circuit and controls lamp brightness.

Line signal for the LINE position of the SOURCE switch is provided from pin 17 of the secondary winding of T900.

**+150 Volt Regulated Supply.** Error sensing for the +150 volt supply is provided by Q911. Error signal voltage in the +150 volt supply is amplified by the cascode amplifier Q911-Q910 and applied through the emitter follower Q900 to the base of the regulator Q901 as a corrective signal.

Diodes D904 and D905 protect Q900 from excessive voltage transients between the collector and emitter of Q900.





# SECTION 4

## MAINTENANCE

### Introduction

This section of the manual pertains to the maintenance and troubleshooting of the Type 491. The first portion of the section describes some general preventive measures to help minimize major problems. This is followed with some corrective maintenance information and information on ordering parts or components. The last and major portion of the section describes the removal and replacement of the sub-assemblies and their components, and some general troubleshooting information pertinent to the Type 491. Trouble symptoms and possible causes are not listed for this instrument because all circuits are interrelated. Listed causes for various troubles could cause confusion. However one misleading trouble symptom may occur when one of the three varactor diodes short. This will clamp the DC output voltage from the phase lock circuit and prevent vertical trace shift as the FINE RF CENTER FREQ control is adjusted which indicates trouble in the phase lock circuit.

#### CAUTION

Removing or replacing the dust cover for the instrument may be hazardous, if the instrument is lifted out of, or slid into the dust cover. Remove or replace the cover as follows: Place the accessory cover on the instrument, Set the instrument on the front-panel cover (do not set the instrument on the front-panel controls). The dust cover may now be removed or replaced with safety and ease.

### PREVENTIVE MAINTENANCE

#### General

Preventive maintenance consists of cleaning, visual inspection, lubrication, and if needed, recalibration. Preventive maintenance is generally more economical than corrective maintenance, since it can usually be done at a time convenient to the user. The preventive maintenance schedule established for the instrument should be based on the amount of use and the environment in which the instrument is used.

#### Cleaning

Clean the instrument often enough to prevent accumulation of dirt. Dirt on the components acts as a thermal insulating blanket (preventing efficient heat dissipation) and may provide electrical conducting paths.

Clean the instrument by loosening the accumulated dust with a dry, soft paint brush. Remove the loosened dirt by vacuum and/or dry low pressure compressed air (high velocity air can damage certain components.) Hardened dirt and grease may be removed with a cotton-tipped swab or a soft cloth dampened with water and a mild detergent solu-

tion (such as Kelite or Spray White). Abrasive cleaners should not be used.

#### CAUTION

Do not permit water to get inside controls or shaft bushings. Avoid the use of chemical cleaning agents which might damage the plastics used in this instrument. Some chemicals to avoid are benzene, toluene, xylene, acetone or similar compounds.

The CRT faceplate, protector plate and filters are as follows:

Clean the plastic light filters, faceplate protector and the CRT face with a soft, lint-free cloth dampened with denatured alcohol. The CRT mesh filter is easily scratched or damaged. It should be cleaned as follows:

1. Hold the filter in a vertical position and brush lightly with a soft water-color brush to remove light coatings of dust or lint.
2. Greasy residues or dried-on dirt are removed with a solution of warm water and a neutral liquid detergent. Use the water-color brush to scrub the filter.
3. Rinse the filter thoroughly in clean water and allow to air dry.
4. If any lint or dirt remains, use clean low-pressure air to remove. Do not use tweezers or other sharp cleaning tools on the filter as the special finish may be damaged.
5. Store the mesh filter in a lint-free, dust-proof container such as a plastic bag.

#### CAUTION

Do not write on the CRT face—use the clean plastic protector plate mounted in the ornamental ring.

#### Lubrication

The life of potentiometers and selector switches is increased if these devices are kept properly lubricated. Use a cleaning type lubricant (such as Cramoline) on shaft bushings and switch contacts. Lubricate the switch detents with a heavier grease (Beacon grease No. 325 or equivalent). Do not over-lubricate. The necessary materials and instructions for proper lubrication of Tektronix instruments are contained in a component lubrication kit which may be ordered from Tektronix. Order Tektronix Part No. 003-0342-00.

The dial and tuning assembly should be lubricated periodically. This is normally every 500 hrs., however if the tuning tends to bind or drag it may be due to improper lubrication.

The gears should be lubricated with a high quality lubricant such as COSMOLUBE No. 102, (Tektronix Part No. 006-1229-00). The bearing surfaces and drive shaft should be oiled with a light weight oil such as Hoppes lubricating oil or Pfaff sewing machine oil.

Lay the instrument on its side. Using a syringe or hypodermic oiler (Tektronix Part No. 003-0280-00) and apply no more than one drop to each point. The gear shafts that are below the RF CENTER FREQUENCY and oscillator tuning shafts can be reached with the hypodermic oiler, or a small wire which will wick the oil to the out-of-the-way points. Do not apply oil to the tuning shaft from the front panel of the instrument.

The lead screw (long threaded shaft) that tunes the C band oscillator cavity should not require lubrication. It should, however, be cleaned with a soft brush and mild detergent solution.

### Visual Inspection

After a thorough cleaning, the instrument should be carefully inspected for such defects as poor connections, damaged ports and improperly seated transistors. The remedy for most visible defects is obvious; however, if heat-damaged parts are discovered, determine the cause of over-heating before the damaged parts are replaced, otherwise the damage may be repeated.

### Transistor Checks

Periodic preventive maintenance checks consisting of removing transistors from the instrument and testing them in a tester, are not recommended. The circuits within the instrument provide the only satisfactory check on transistor performance. Defective transistors are usually detected during recalibration of the instrument. Details of in-circuit transistor checks are given in the troubleshooting procedure in this section.

### Performance Checks and Recalibration

To insure accurate measurements, the instrument performance should be checked after each 500 hours of operation or every six months if the instrument is used intermittently. The calibration procedure is helpful, both in the isolation of major troubles in the instrument, and in locating minor troubles which are not apparent during regular operation. Instruction on how to conduct a performance check are given in Section 5, Calibration instructions are described in Section 6.

## CORRECTIVE MAINTENANCE

Corrective maintenance consists of component replacement and instrument repair. Special techniques or procedures required to replace components in this instrument are described in this section.

#### NOTE

Maintenance and repair of the RF Local Oscillator, Mixer and Filter sections should not be attempted. The oscillator tubes and mixer diodes can be

replaced provided reasonable care is used, and their replacement is performed by competent personnel. (See replacement instructions in this section.) Circuit components have been selected and positioned at the factory using special test equipment. Tracking adjustments for the local oscillator section require special test equipment and tools.

### Obtaining Replacement Parts

Before purchasing or ordering replacement parts, consult the Parts List for value, tolerance and rating. The Parts sections contain instructions on how to order replacement parts from Tektronix.

#### NOTE

When selecting the replacement parts, it is important to remember that the physical size and shape of the component may affect its performance in the circuit.

### Component Numbering and Identification

The circuit number of each electrical part is shown on the circuit diagrams. A functional group of circuits (such

TABLE 4-1

Component No. Series	Circuit Group	Circuit Diagram
1-99	RF Section	1
100-149	Wide Band Amplifier	4
150-199	IF Attenuator	5
200-279	Dispersion Circuit	3
280-399	Sweep Circuit	3
400-499	Narrow Band Amplifier	6
500-560	Variable Resolution Amplifier	7
600-659	Video Detector	8
660-690	Vertical Amplifier	8
700-749	Trigger Circuit	9
759-809	Sweep Generator and Timing Switch	9 & 10
810-839	Horizontal Amplifier	9
900-969	Power Supply	11
1000-1049	CRT Circuit	13
1050-1075	Baseline Suppress or Intensifier	13
1080-1090	Blanking Circuit	13
1100-1199	Phase Lock Circuit	2

as the RF Section) is assigned a particular series of numbers. Table 4-1 lists the assigned component numbers for the various circuits,

Switch wafers are identified by counting from the first wafer, located behind the detent section of the switch, towards the last wafer. For example, the designation 2R printed by a switch section on a schematic, identifies the switch section as the rear side of the second wafer when counting back from the switch detent section.

## Resistor Color Code

The instrument contains a number of stable metal-film resistors identified by their gray background color and color coding. If a resistor has three significant figures and a multiplier, it will be EIA color coded. If it has four significant figures and a multiplier, the value will normally be printed on the resistor. For example, a 332 resistor will be color coded, but a 332.5 k resistor will have its value printed on the resistor body. The color-coding sequence is shown in Fig. 4-1.

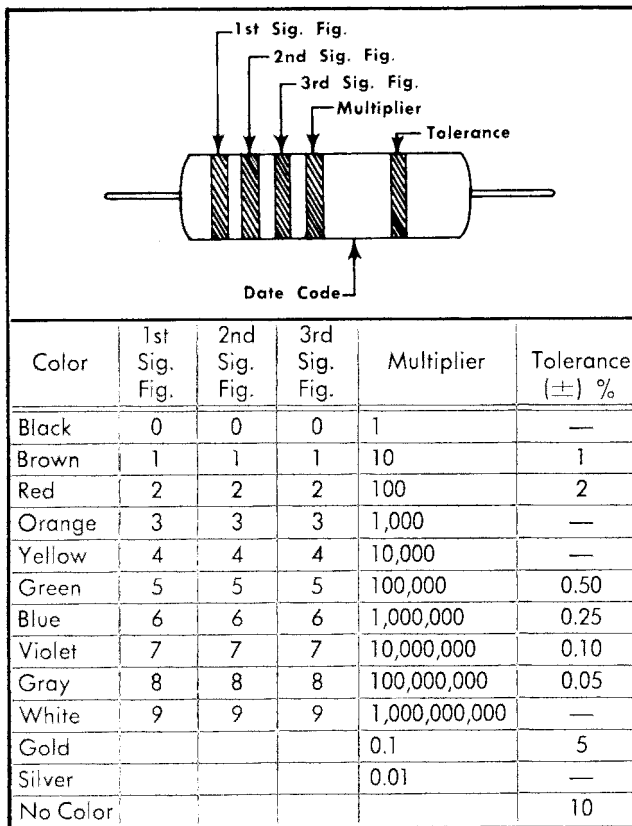

Fig. 4-1. Standard EIA color code for metal-film resistors.

Fig. 4-2 identifies the polarity of the glass diode types used in this instrument.

## Wiring Color Code

The insulated wire used in the Type 491 is color-coded according to the EIA standard color code to facilitate circuit

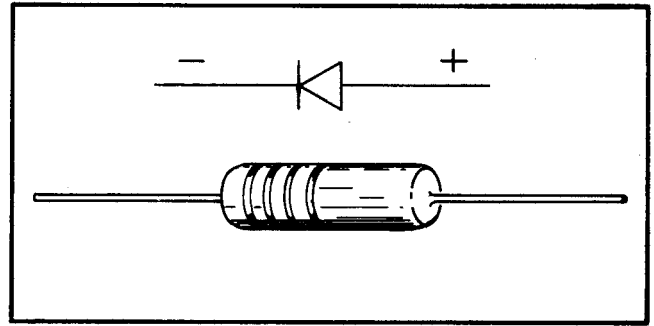

Fig. 4-2. Diode polarity for glass diodes.

tracing. The widest color stripe identifies the first color of the code. Power supply voltages can be identified by three color stripes and the background. White background indicates a positive supply, and a tan background is used to indicate a negative supply. Table 4-2 shows the wiring color code for the power supply voltages used in the Type 491. The color coding helps trace a wire from one point in the instrument to another.

TABLE 4-2

Supply	Back-ground Color	1st Stripe (1st No.)	2nd Stripe (2nd No.)	3rd Stripe (3rd No.)
-10 V	Tan	Brown	Red	Black
+10 V	White	Black	Brown	
+150 V	White	Brown	Green	Brown

RF cables for the RF and IF sections are miniature coaxial cables. Some of these cables have a lossy characteristic and are identified with a white outside coating. The standard 50 ohm low-loss coaxial cables have a clear plastic outside coating. Do not interchange the lossy type with the standard 50  $\Omega$  type when these coaxial cables are replaced.

## Removing and Replacing Assemblies

### WARNING

Disconnect the instrument from the power source before attempting repair and/or replacement of any sub-assembly.

## Circuit Board Assembly Removal or Replacement

If a circuit board assembly is damaged beyond repair, the entire assembly including all components should be replaced. The board assembly part number is listed in the Mechanical Parts List and may be ordered as directed.

In most cases the complete circuit board assembly should be removed when components are to be replaced. This will allow a soldering-iron tip to be placed at the back side or bottom of the board to unsolder the component leads and remove the damaged component. The new com-

ponent can then be correctly soldered in its place, Observe soldering precautions and techniques as described in Soldering Techniques later in this section.

The interconnecting wires to the boards are sufficiently long that the boards may be loosened and re-positioned for troubleshooting without disconnecting the pin connectors. The procedure for removing these circuit board assemblies is as follows:

1. Remove the mounting screws holding the board in position.
2. Slip the cable out of the delrin cable clamps if the IF board is to be removed.
3. Disconnect the necessary pin connectors to allow the board to be lifted and turned as required for maintenance.
4. If complete removal is desired, remove all the pin connectors and soldered leads.
5. To replace the board, reverse the removal procedure. Correct wire and pin connections for each circuit board assembly are shown in Figs. 4-3 through 4-9.

Make certain the pin connectors are perpendicular with the pins when connecting to prevent bending or spreading

the pin connectors. If the connectors are grasped near the wire end by a pair of needle nose pliers, their removal or installation is relatively easy.

### Removal of the High Voltage Compartment

Components in the high voltage compartment can be removed for maintenance or replacement as follows:

1. Remove the two mounting screws and high voltage shield over the compartment.
2. Slide the high voltage components out of the plastic compartment and replace as necessary.
3. Reverse the procedure for replacing the high voltage assembly.

### Removing the Honeycomb Assembly

1. Remove the six (6) nuts and washers that hold the IF ATTENUATOR dB switches at the front panel assembly.
2. Remove the chassis mounting screw and grounding lug located at the outside rear end and loosen the inside rear mounting screw. See Fig. 4-10.

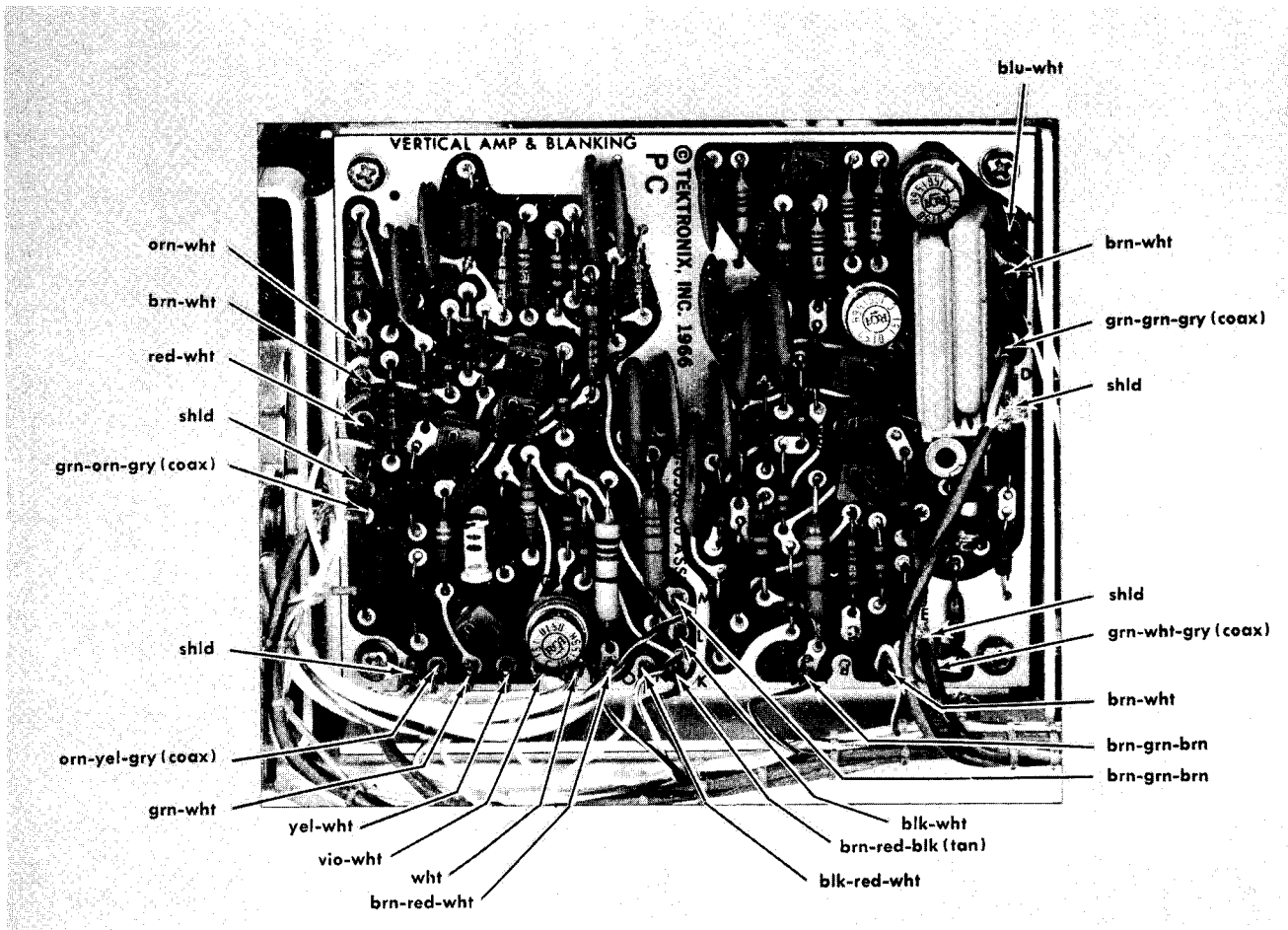

Fig. 4-3. Vertical Amplifier circuit board with wiring color code to pin connectors.



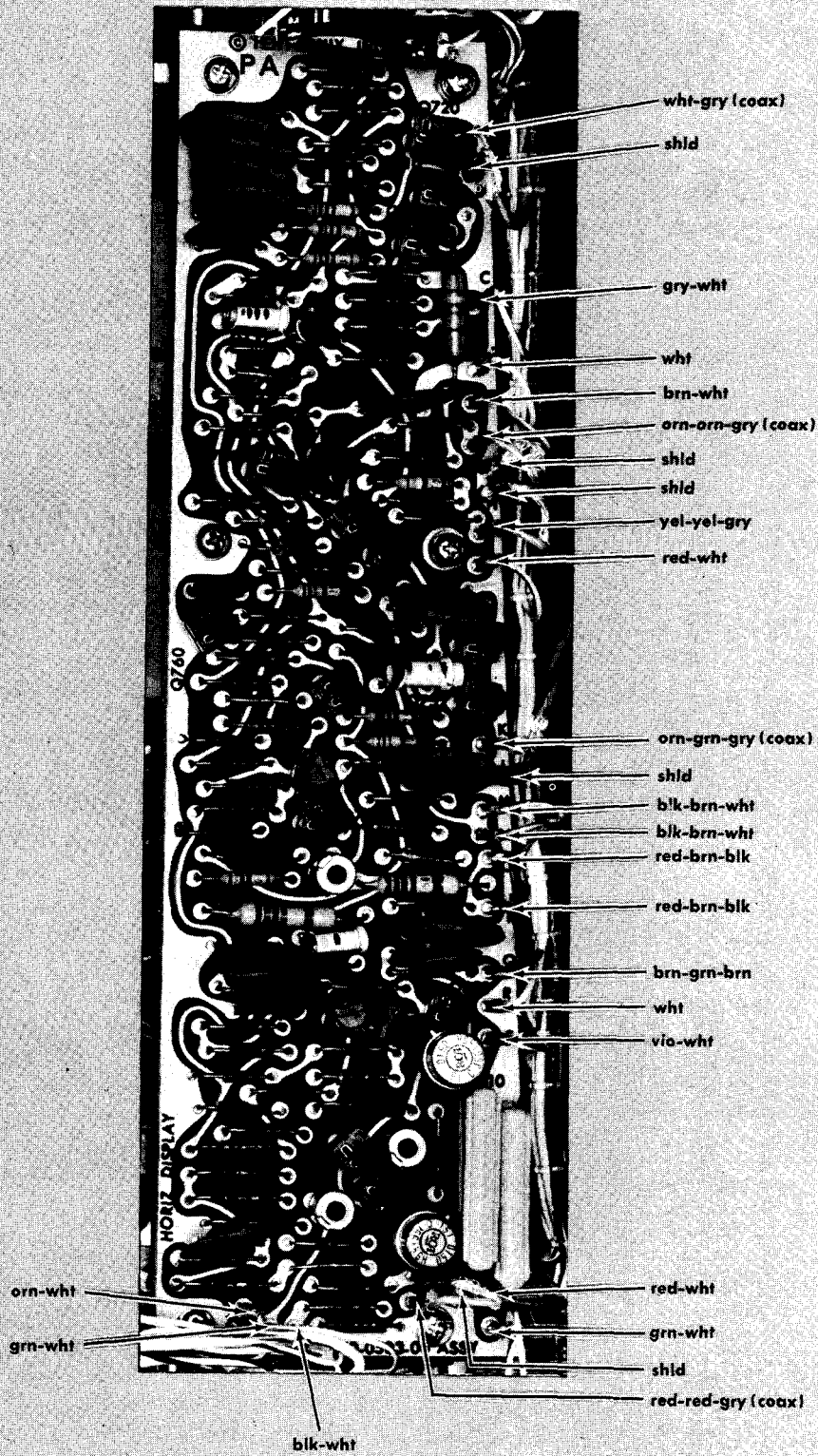

Fig. 4-5. Horizontal Display circuit board assembly showing color code to pin connectors.

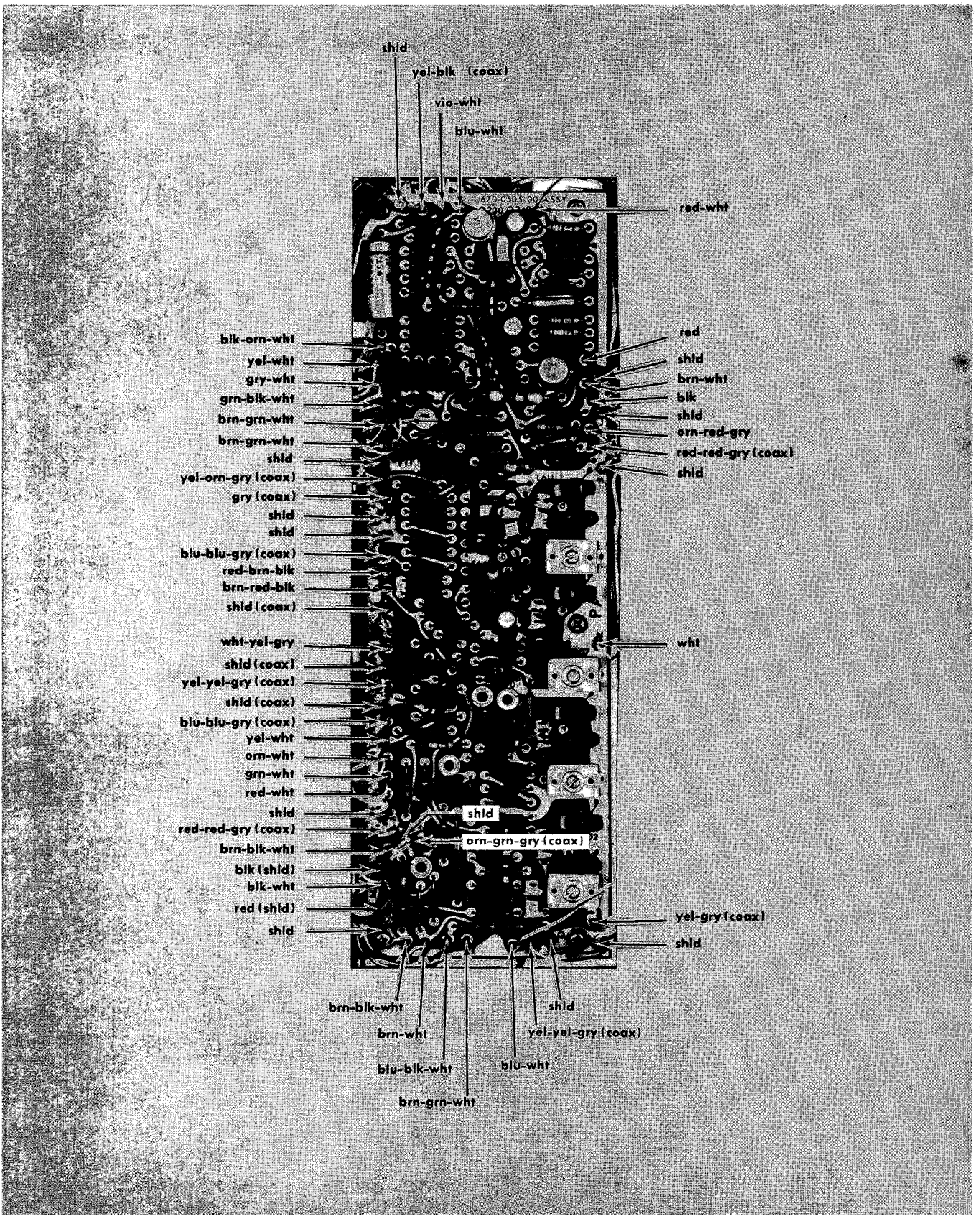

Fig. 4-6. IF Control board assembly. Wiring color code to pin connector.

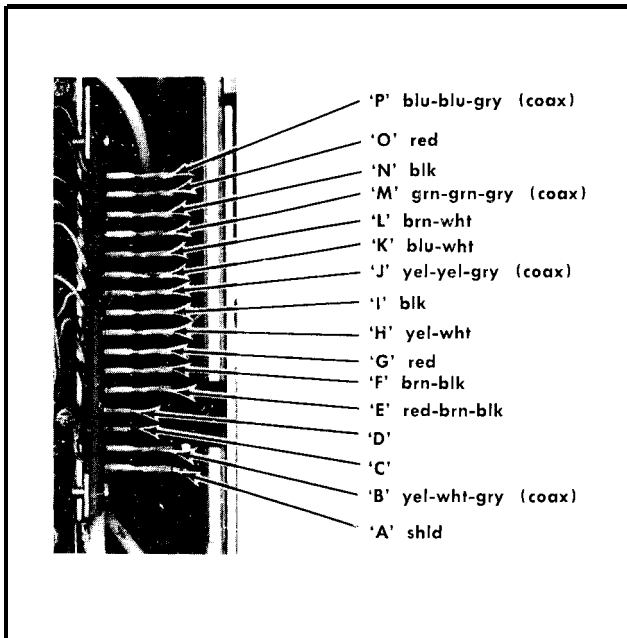

Fig. 4-7. Honeycomb assembly and wire color code to the pin connector.

3. Turn the Type 491 on its side (see Fig. 4-11). Remove the nylon rocker arm from the DISPERSION RANGE switch SW365.

4. Unlock the IF control assembly and swing the circuit board assembly up to its fully extended position. Now gently remove the honeycomb assembly by slipping the assembly towards the rear to free the mounting screw head and pulling the assembly out and to the rear.

5. Turn the honeycomb assembly over and place it upside down on a block or box as shown in Fig. 4-11. CAUTION-Do not bend or damage the pin connectors.

6. Remove the screws that fasten the bottom plate to the assembly and remove the bottom plate.

7. If power is to be applied, make certain all connections are correct to the square pin connector and the connectors are free of short circuit conditions. The DISPERSION RANGE switch must be manually switched on the honeycomb assembly when changing DISPERSION RANGE positions. Fig. 4-11 shows the circuit sections in each cell of the honeycomb assembly.

## Cathode-Ray Tube Replacement

Protective clothing and safety glasses should be worn when handling the CRT. Avoid striking the tube on any object which might cause the tube to crack or implode. The CRT may be stored by placing the tube face down on a smooth surface with a protective cover or soft mat under the faceplate to prevent scratches.

The removal and replacement procedure for the CRT tube and shield assembly is as follows:

1. Unsolder the trace rotation leads.

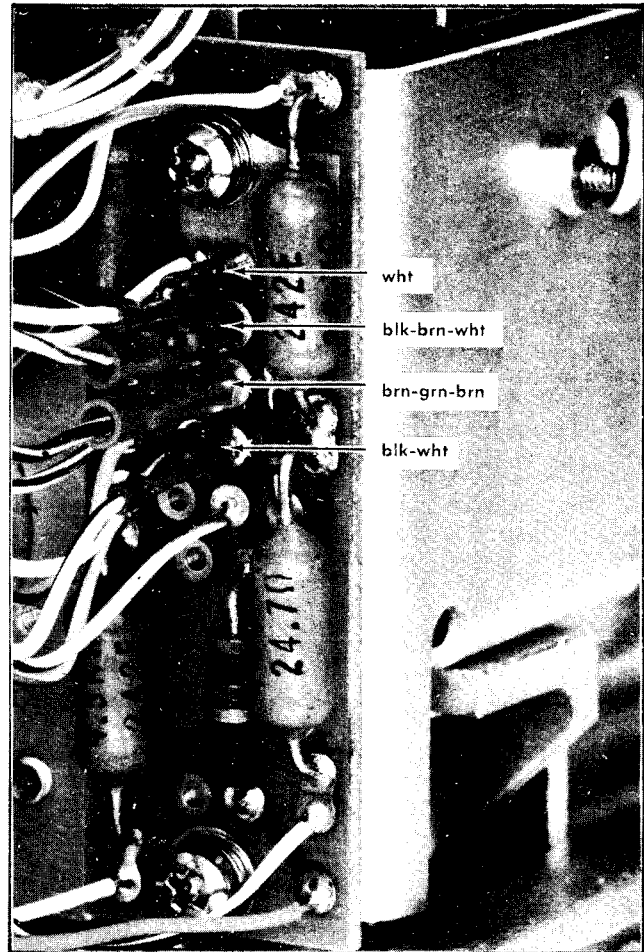

Fig. 4-8. Connector assembly board for the RF oscillator assembly and wiring color code to the pin connector.

2. Disconnect the deflection plate pin connectors, Pull out on the connectors so the pins will not be bent.

3. Remove the CRT base socket,

4. Remove the two (2) nuts and graticule light holders which secure the front of the CRT shield to the subpanel. Remove the graticule lights from the studs and position them out of the way.

5. Remove the two phillips-head screws that hold the two right angle mounting brackets at the base of the CRT shield. See Fig. 4-12.

6. Slide the CRT assembly to the rear of the instrument until the faceplate clears the mounting studs; twist the assembly clockwise to clear the right angle brackets, then lift the assembly up and out of the instrument.

7. Loosen the slot screw at the base of the CRT clamp inside the CRT shield.

8. Place the left hand on the CRT faceplate and push forward on the tube base with the right hand to slip it out of the base clamp. As the CRT starts out of the shield, grasp it firmly with the left hand. When the tube is free of the clamp, slide the shield completely off the CRT.



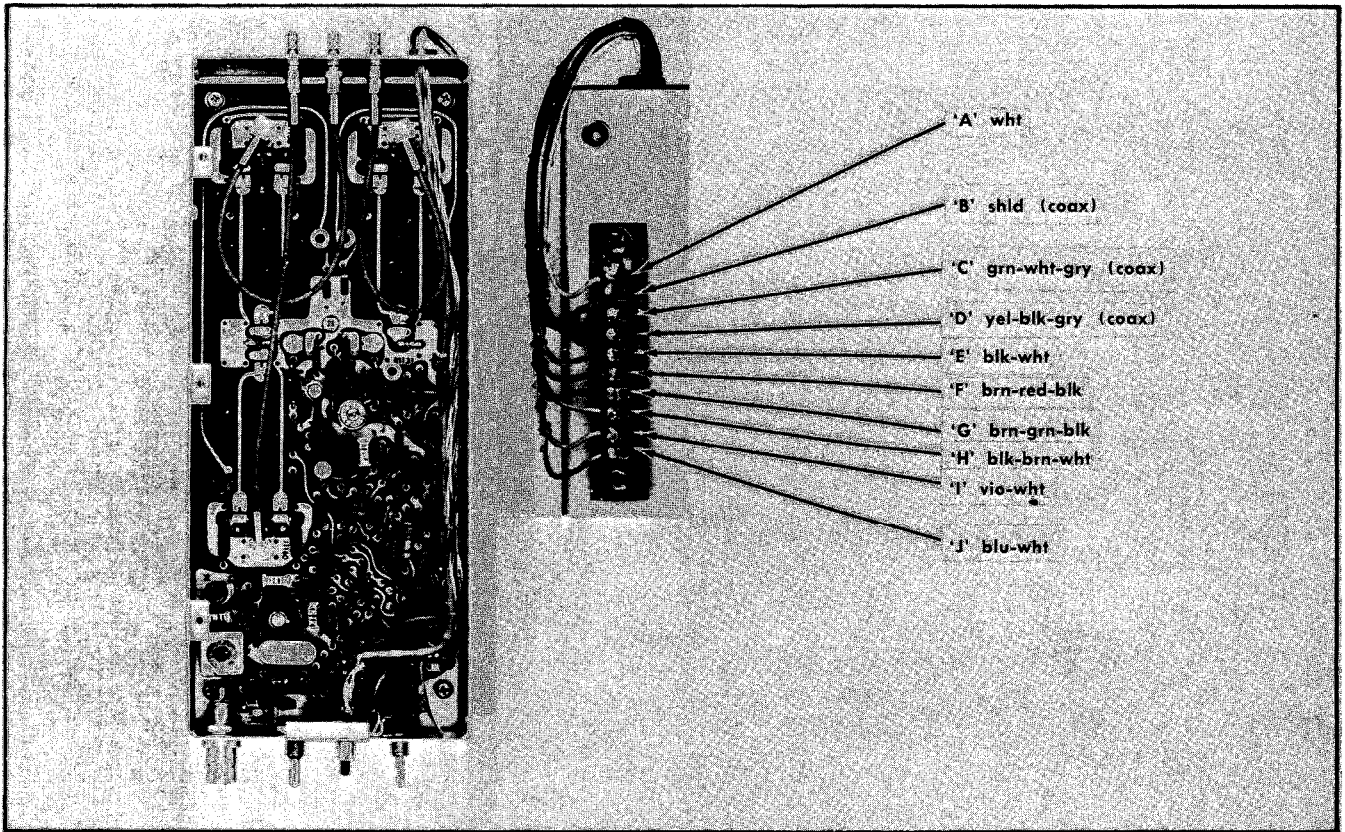

Fig. 4-9. Phase lock assembly and wiring color code to the pin connector.

To replace the CRT, reverse the removal procedure. Make certain the faceplate of the CRT seats properly against the front panel. It may be necessary to loosen the two side screws at the side of the tube clamp and realign the tube base. Tighten the bottom clamp screw approximately 4 to 7 inch-pounds.

After the tube and assembly have been replaced, adjust the high voltage, high voltage current and trace rotation. The procedure is given in the Calibration section.

### Removing the TIME/DIV Switch Assembly

The horizontal display board may either be removed before removing the switch assembly, or it can remain mounted. If the board is not removed, disconnect the necessary pin connectors to the board so the assembly can be removed.

1. Remove the VARIABLE and TIME/DIV control knobs, plus the mounting nuts and washers.
2. Disconnect the lead from capacitor C701, at pin C of the pin connector. Snap the nylon mounting bracket for the capacitor C701 off the switch struts. See Fig. 4-13A.
3. Loosen the two screws (Fig. 4-13B) through the two nylon supports that hold the switch strut to the main frame. These nylon supports are just forward of the switch wafer section. Twist the nylon support studs off the switch struts.



Fig. 4-10. Mounting screws for the honeycomb assembly.

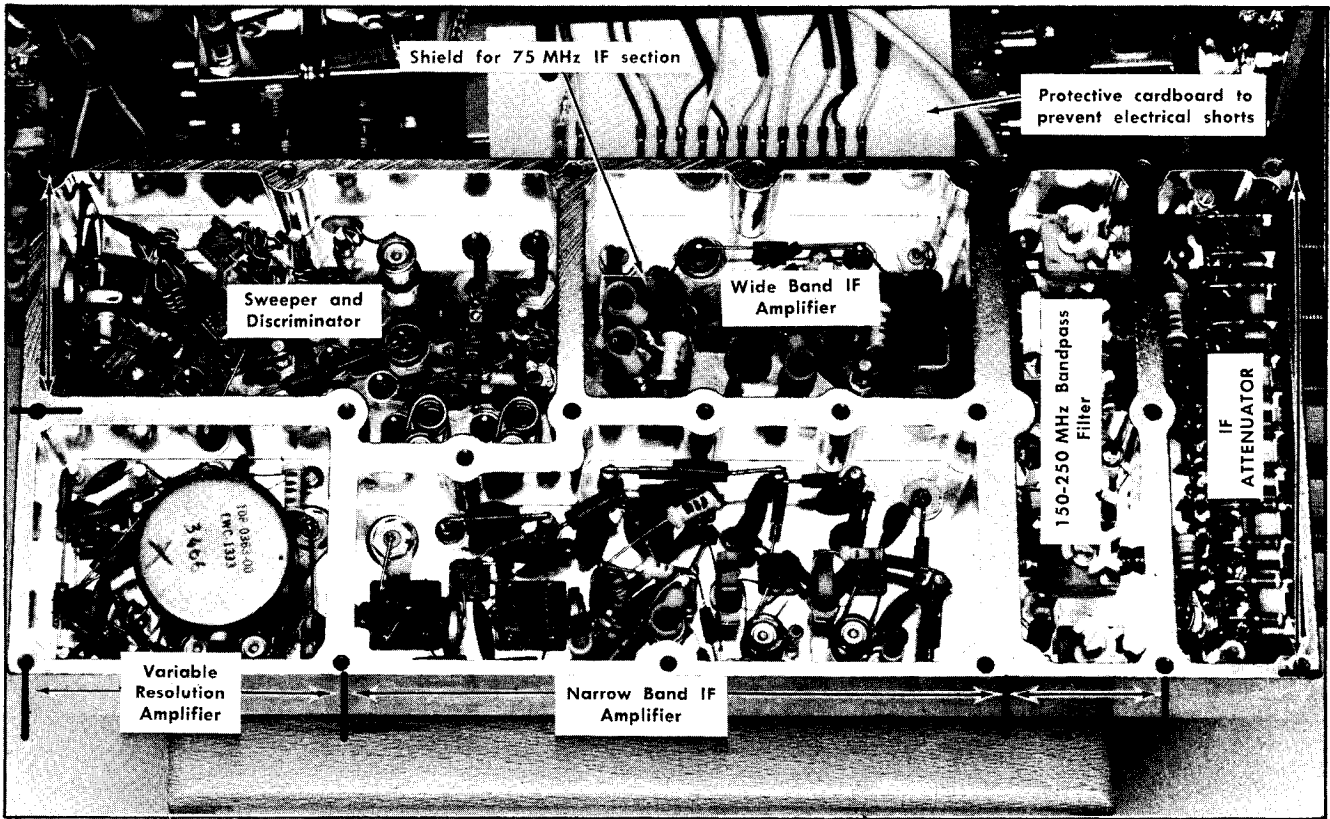

Fig. 4-11. Honeycomb assembly open and ready for voltage and waveform measurements.

4. Loosen the two nuts that secure the back of the switch assembly to the rear mounting bracket.

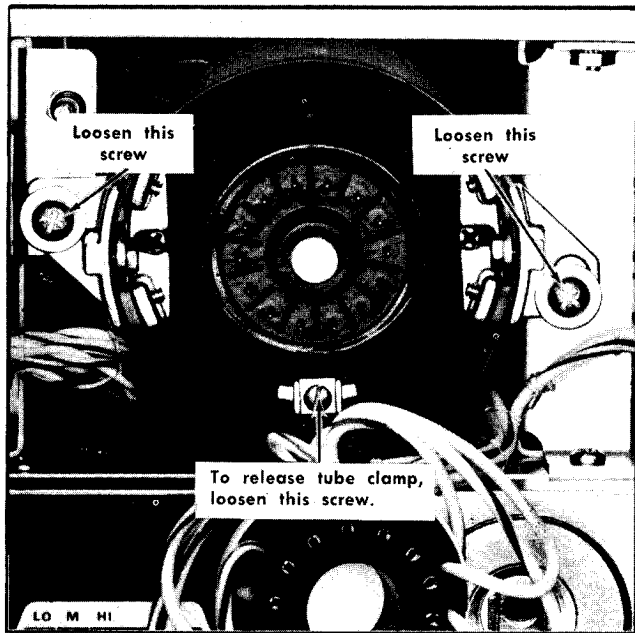

Fig. 4-12. Removing the CRT assembly,

5. Lift the switch assembly up so the studs clear the mounting bracket, then slide the assembly back and out of the instrument.

Reverse the removal procedure to remount the switch assembly.

#### Removal of the DISPERSION RANGE Switch

1. Loosen the shaft coupling set screws. See Fig. 4-14A.
2. Grasp the nylon rocker arm linkage at the switch (SW365) end and lift the linkage off the switch lever.
3. Remove the two mounting screws that hold the switch assembly mounting bracket to the side frame.
4. Slide the switch assembly back and lift the assembly out.
5. Loosen the set screws for the drive gears on both the switch shaft and the drive shaft. Loosen the set screw through the mounting bracket casting (Fig. 4-14).
6. Pull the switch shaft to separate the two gears, then unscrew the mounting bracket casting off the switch.
7. To replace, reverse the removal procedure, however, make certain the new switch is in the same switched position as the removed switch before tightening the drive gear set screws.

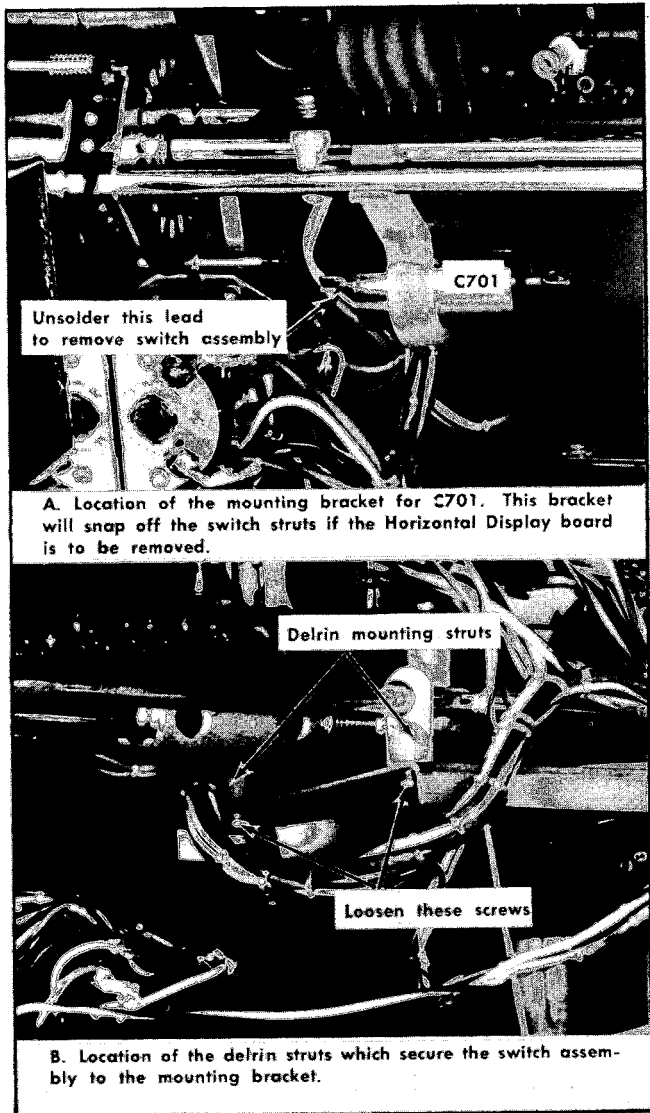

Fig. 4-13. Removing the TIME/DIV switch. Local oscillator assembly removed to show the location of the mounting hardware.

After the assembly is remounted, it may be necessary to reposition the rocker arm linkage on the drive shaft. This can be done as follows: Loosen the set screws, slip the rocker arm cup over the switch SW365, then retighten the set screws.

### Removing the SOURCE, SLOPE switch and LEVEL control

1. Remove the CRT assembly.
2. Remove the knobs and the LEVEL control mounting nut and washer.
3. Use a flexshaft-drive socket wrench to loosen the switch mounting nuts.
4. Lift the switches and/or the LEVEL control out of the area.

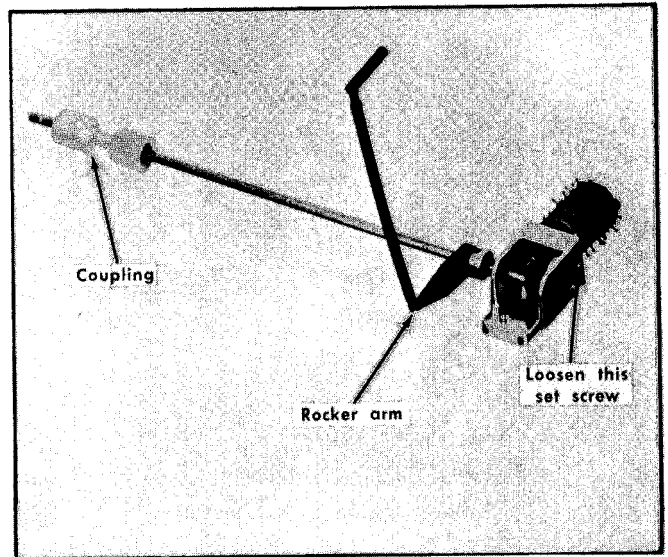

Fig. 4-14. Dispersion range switch removal.

Replacement of these switches or the control is the reverse of the removal procedure.

### Replacing the Pilot Light

Unscrew the colored pilot light cover. Pull out the bulb and replace.

### Removing the Cover to the Phase Lock Assembly (Fig. 4-15)

1. Remove the B band Mixer assembly by removing the front panel mounting nut and washer for the assembly. Slide the assembly to the rear, then lift out and position the assembly so that it is clear of the cover.
2. Loosen the large barrel nut on the C band receptacle, then disconnect the right angle Seaelectro connector from the diplexer. Remove the receptacle assembly. (A number of turns are required to unscrew the barrel nut before the receptacle can be removed.)
3. Remove the knob and hardware for the MIXER PEAKING control. Slip the control free.
4. Unlatch the IF control board assembly and lift the assembly board up out of the way.
5. Remove the 5 cover screws. Disconnect the cables to J34 and J80 of the filter assemblies. Disconnect the sub-miniature connector to J10 of the band A Mixer assembly.
6. Slide the Phase Lock assembly cover to the rear and lift up and out until it clears, then turn the cover to the side to gain access to the inside of the box. Voltage measurements may now be taken after insuring that there are no electrical shorts at the pin connector to the Honeycomb assembly.

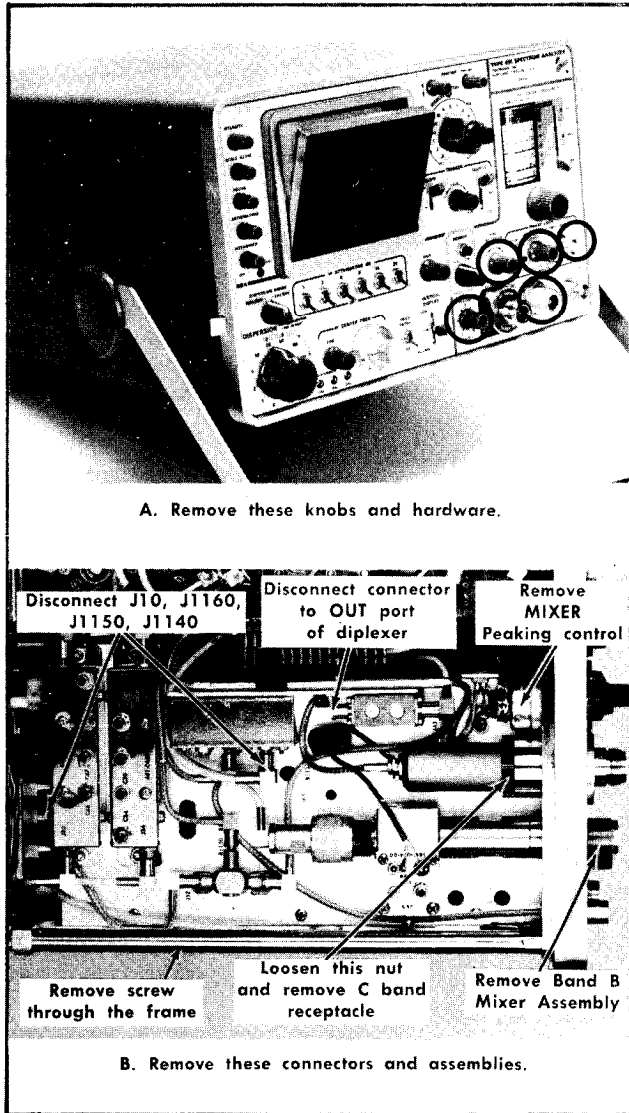

Fig. 4-15. Removing the Phase Lock assembly.

### Removing the Phase Lock Assembly

1. Repeat steps 1 through 3 of the above procedure, then remove the knob and hardware for the FINE RF CENTER FREQ, the INT REF FREQ controls and the LOCK CHECK button switch.
  2. Remove the mounting screws through the side frame to the assembly box.
  3. Disconnect the three right angle sub-miniature connectors at the back of the phase lock assembly (J1140, J1150 and J1160).
  4. Slide the phase lock assembly back and lift up and out of the unit. Set the assembly on a block or the table top. Power can now be applied to the unit for voltage or waveform measurements.
- If the assembly is to be removed and replaced, disconnect the pin connectors.

### Removing the Circuit Board Assembly for the Phase Lock (See Fig. 4-16)

1. Remove the retainer nuts on the connectors J1140, J1150 and J1160.
2. Remove the two screws that secure the pin connector to the chassis,
3. Unsolder the wires to the INT FREQ control and remove the potentiometer.
4. Unsolder the wire to the 1 MHz MARKERS OUT connector.
5. Remove the hardware to the RF CENTER FREQ potentiometer and the LOCK CHECK switch button. Push the controls into the box,
6. Remove the five mounting screws.
7. Pull the cable into the box to provide cable slack, then lift the board up and slide clear of the chassis lip.

When reassembling the board into the box, be sure to install the wires on the pin connector before replacing the box assembly.

8. Remount the assembly using the reverse of the removal procedure. Do not force the assembly into place, Check the wiring and connectors to avoid wire pinching or strain on the connectors.

### Removing the Line Voltage Selector

Use a pin extractor, Model 107 R-1001; manufactured by Winchester Electronics Div. of Litton Industries, or equivalent to remove the wire and pins from the connector. The pins are re-inserted into the selector with a pair of needle nose pliers.

### Removing the Oscillator Assembly (Fig. 4-17)

1. Remove the tuning knob and the band switch knob, then remove the flat head screw under the tuning shaft.
2. Disconnect the sub-miniature right angle coaxial connectors and the pin connectors to the oscillator assembly.
3. Remove the two mounting bracket screws under the coaxial band switch. See Fig. 4-17A.
4. Remove the two nuts securing the drive gear assembly to the front panel assembly. See Fig. 4-178.
5. Pull the oscillator assembly back and up to remove.

To replace the assembly, reverse the removal procedure. The two drive gear assembly mounting nuts and the flat head screw should be installed before the mounting bracket screws are replaced. To align the assembly, loosen the two mounting nuts for the bracket assembly and slip the mounting bracket in the slots provided; then tighten the nuts,

### Replacing Mixer Diodes

Mixer diodes are sensitive to RF electrical fields and static charges. Exposure to these fields may damage the replacement diode.

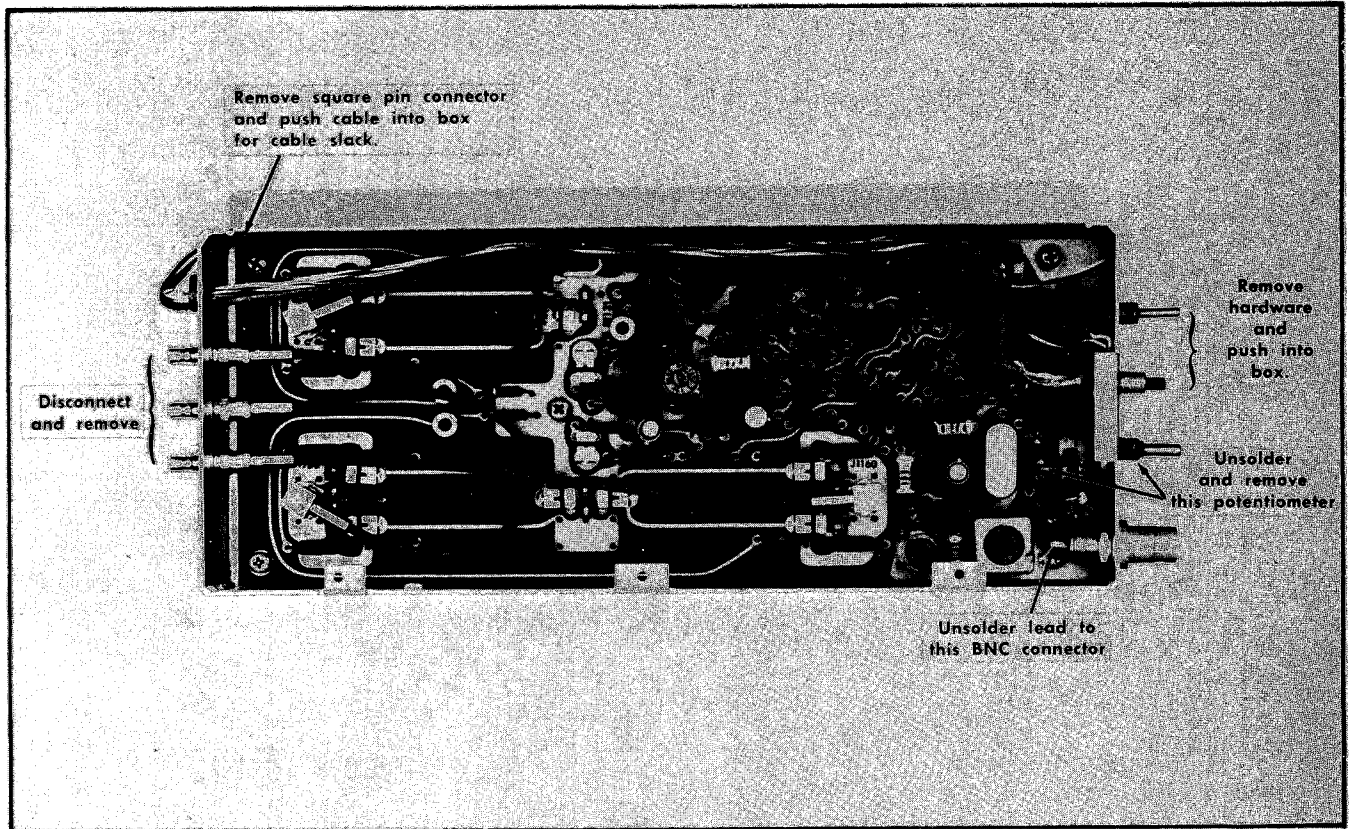

Fig. 4-16. Removing the phase-lock assembly board.

#### 1. Band A Mixer Diodes

- a. Disconnect the sub-miniature connectors, remove the two mounting screws and the mixer assembly.

#### CAUTION

Do not tip or bend the connectors in removing them. Grasp the body of the connector with the fingers or needle nose pliers at the base of the connector, and pull straight out.

- b. Remove the four screws and spacers that hold the cover and circuit plate to the shell.

- c. Unsolder and replace the diodes with a matched pair. See Fig. 4-18A. USE A HEAT SINK WHEN SOLDERING THE NEW DIODES INTO PLACE, SEE SOLDERING TECHNIQUE.

- e. Replace the cover and the mixer assembly. Reconnect the connectors to the mixer assembly.

#### 2. Band B Mixer Diode

- a. Remove the front panel mounting nut and washer.
- b. Slip the mixer assembly back and out of the unit.
- c. Unscrew the front barrel (1 dB pad) and replace the mixer diode. See Fig. 4-18B.

#### 3. Band C Mixer Diodes

- a. Coaxial Mixer. Unscrew the base of the coaxial mixer. Fig. 4-18C. Replace the diode and re-assemble the mixer.

- b. Waveguide Mixers. Unscrew the cap over diode and replace the diode. See Fig. 4-18D.

### Oscillator Tube Replacement

#### NOTE

A complete oscillator assembly and its sub parts are listed in the Mechanical Parts section. Replacing components such as the oscillator tubes requires a complete recalibration with special test equipment and technique. We therefore recommend replacing the complete assembly and returning the defective assembly to your Tektronix Field office or representative. A calibration procedure is provided in the Calibration section, if it is impractical to return the assembly for repair.

The oscillator tube should only be replaced after all tests indicate the tube is faulty. Check supply voltages, etc., as illustrated in Fig. 4-19A.

#### 1. Band A and B oscillator tube replacement (V40 and V41)

- a. Unscrew and remove the screws that hold the tap plate to the oscillator chamber. Remove the top plate.

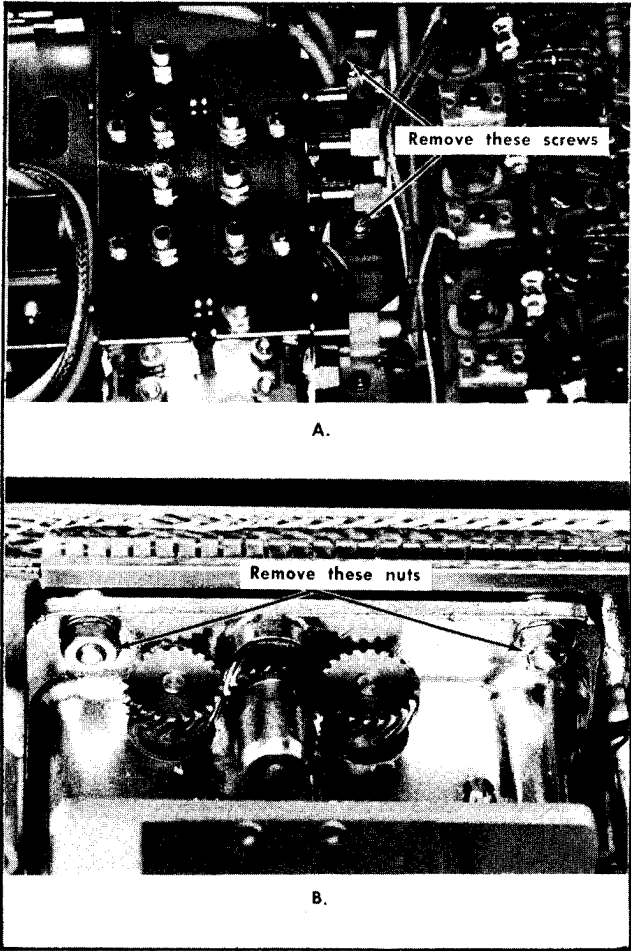

Fig. 4-17. Preparation to remove the oscillator and tuner assembly.

b. Slide the oscillator tube out of the mounting flanges by gently pushing the tube with a plastic or fiber dowel. See Fig. 4-19B.

c. Insert the new tube and slide into place. Do not bend the two contact fingers for the filament buttons.

d. Replace the cover and secure all mounting screws. Tighten the screws uniformly.

e. Refer to the Calibration section to calibrate the oscillator and check its operation.

## 2. Band C oscillator tube replacement (V42)

The procedure to replace this tube is described and illustrated in Fig. 4-20A and 4-20B.

## Component Replacement

The physical size and shape of the replaced component may affect the performance of the circuit, therefore it is best to duplicate the original component as much as possible. Parts orientation and lead dress should also duplicate those of the original part since many of the components are mounted in such a way as to reduce or control circuit capacitance and inductance. After repair, the circuits of the instrument may need recalibration.

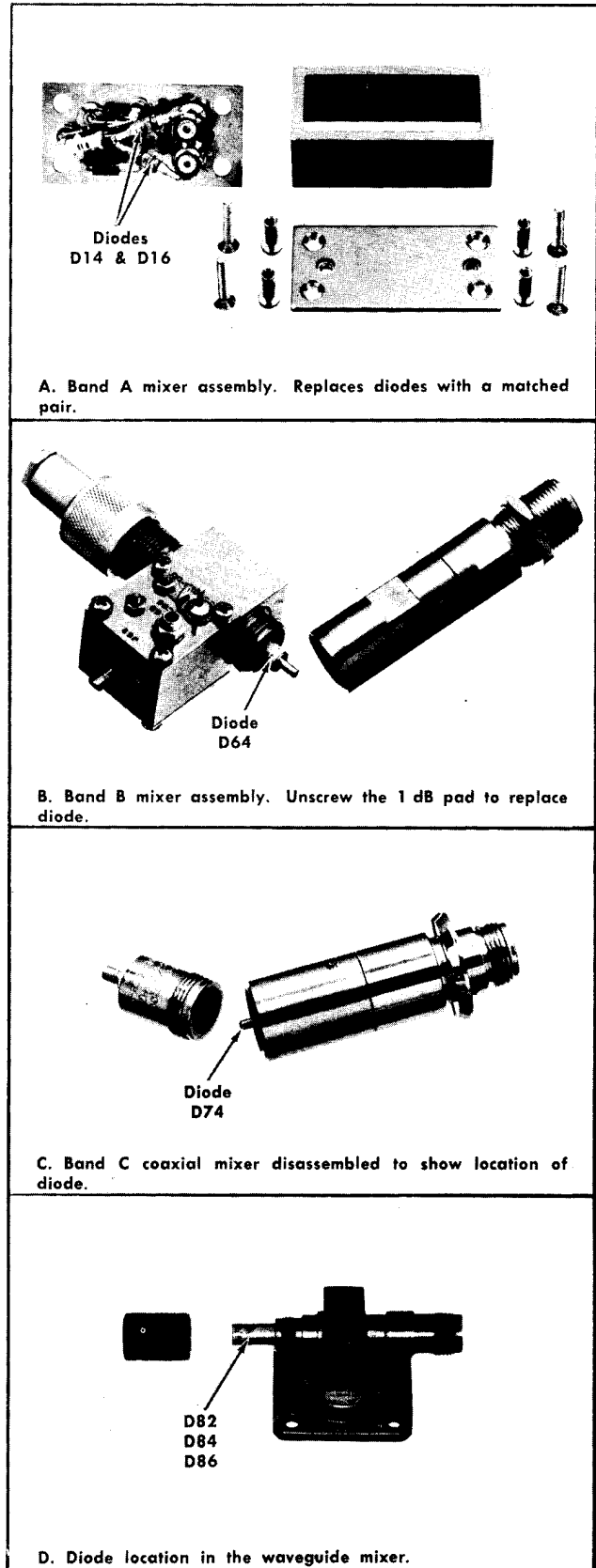

Fig. 4-18. Replacing the mixer diodes.

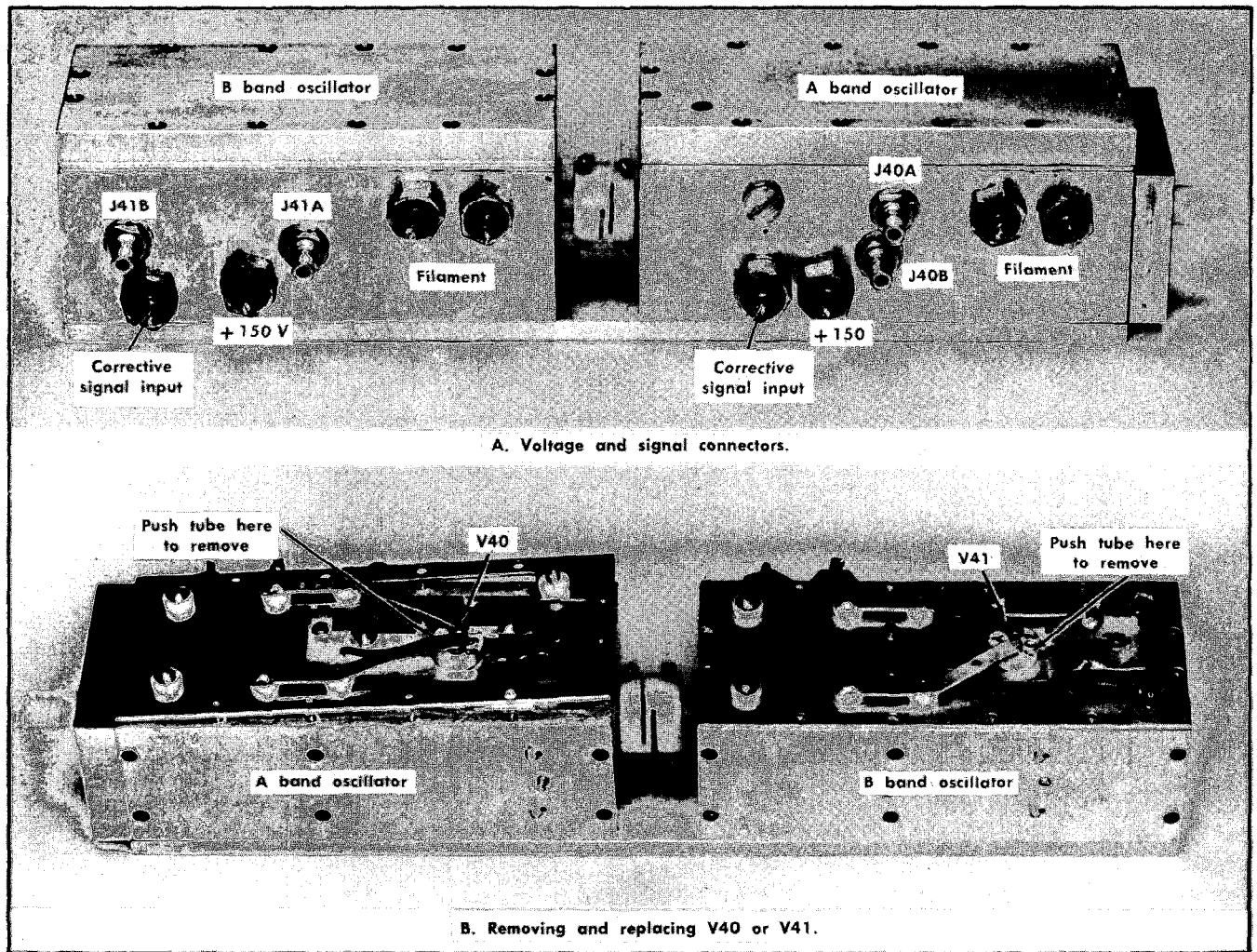

Fig. 4-19. Band A and B local oscillator assemblies.

## Replacing Components on the Circuit Boards

It is best to remove the circuit board assembly to replace components, because melted solder at the connections will wick through the plated eyelets and can produce electrical shorts. If the component is replaced without removing the board make certain an electrical short does not exist.

Use electronic grade 60/40 solder and a 15-watt pencil soldering iron with a  $\frac{1}{8}$  inch or smaller, chisel tip. The soldering iron tip should be clean and properly tinned for maximum heat transfer. Higher wattage irons may damage the bond between the etched wiring and the base material.

The following technique is suggested in the replacement of a component on the circuit board assembly:

1. Remove the component by cutting the leads near the body. This frees the leads for individual unsoldering,

2. Grip the lead with needle-nose pliers. Apply the tip of the soldering iron to the connection at the back of the board, then pull gently to remove the lead.

3. When the lead comes out of the board it should leave a clean hole. If not, the hole should be cleaned by reheating the solder and placing a sharp object such as a wooden toothpick or enameled wire into the hole to remove the old solder.

4. Clean the leads on the new component and bend them to the correct shape to fit into the holes. Insert the leads, making certain the component seats the same as the original,

5. Apply the iron to the connection at the back of the board and apply only the amount of solder required to form a good electrical connection.

6. Check the front or component side of the board to insure that the solder has filled the plated eyelet.

### NOTE

Some components can be damaged by heat. A hemostat or forceps, between the component and the connection will protect the component from excessive heat.

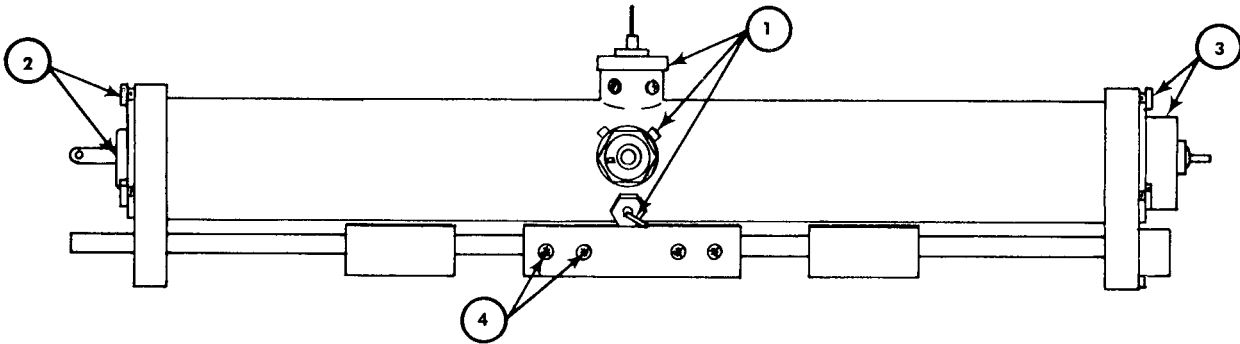

1. Remove (6) setscrews and (3) probes from collars, remove trimmer.
2. Remove (3) 2-56 screws, unsolder center lead and remove endplate.
3. Remove (3) 2-56 screws, pull end cap back, unsolder (2) wires and remove.
4. Loosen (2) setscrews. Do not intermix these with others.

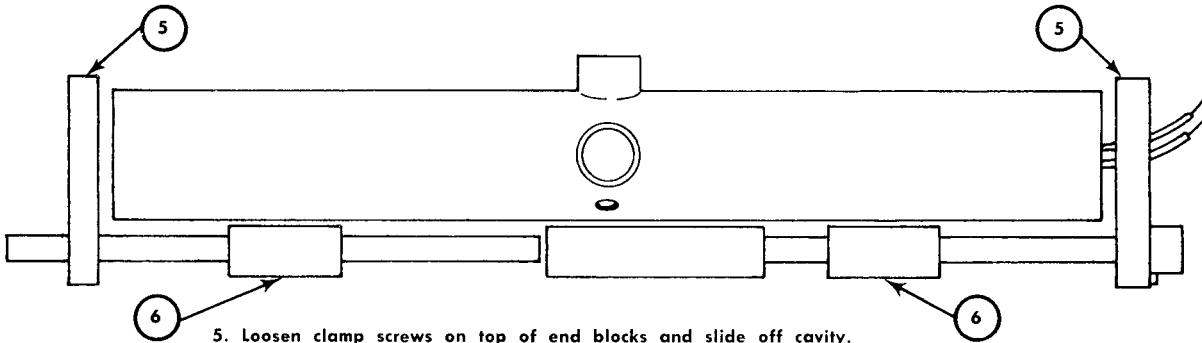

5. Loosen clamp screws on top of end blocks and slide off cavity.
6. Pull tuning nuts straight out of cavity.

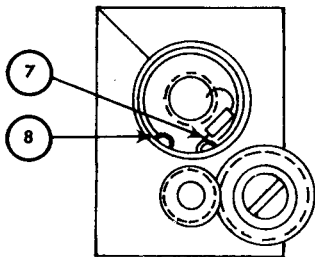

7. Unsolder resistor from snap ring.
8. Remove snap ring from each end.

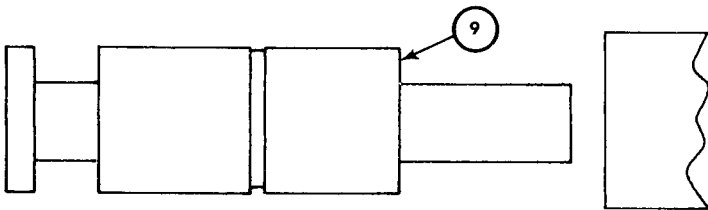

9. Remove choke assembly from each end.

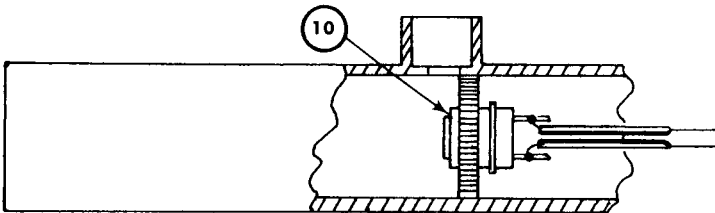

10. Push tube subassembly from cavity using .750 maximum O.D.  $\times$  6.5 min long tubing. Should have .375 min I.D.

Fig. 4-20A. Tube subassembly removal procedure.



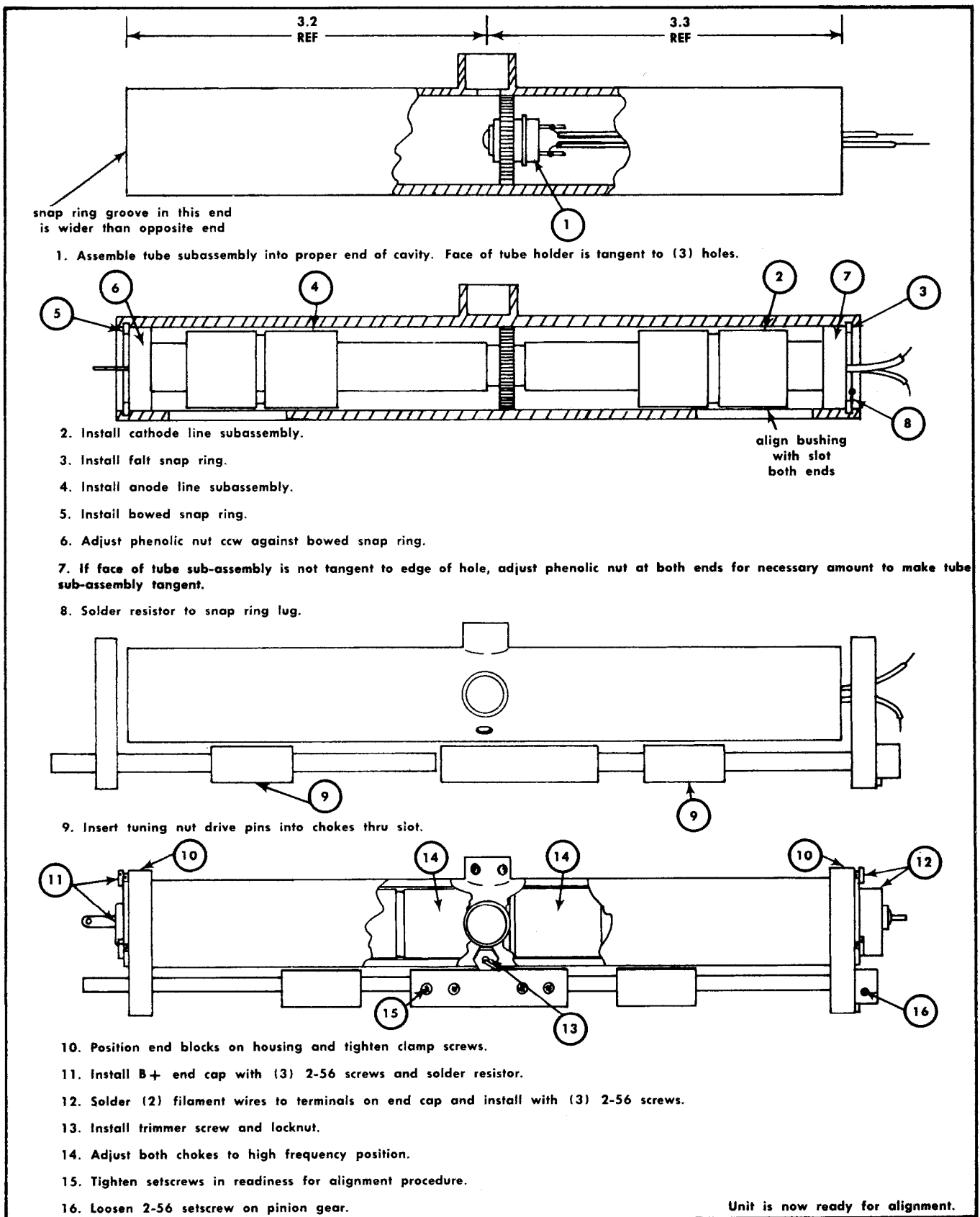

Fig. 4-20B. Tube subassembly installation procedure.

7. Clip off any excess leads that protrude through the hole in the board.

8. If necessary, clean the area around the soldered connection with a flux-remover solvent to maintain good environmental characteristics,

### Replacing Components on Metal Terminals

When soldering metal terminals (e.g., switch terminals, potentiometers, etc.) ordinary 60/40 solder is satisfactory. The soldering iron should have a 40- to 75-watt rating and a 1/8 inch chisel tip.

1. Apply only enough heat to make the solder flow freely and form a good electrical connection. Excess solder may impair the operation of the circuit or cover a cold solder joint.

2. Clip off excess wire that may extend past the soldered connection and clean with flux-remover solvent,

### Removing and Replacing Switches

Single wafers on the VOLTS/DIV or DISPERSION-COUPLED RESOLUTION switches are not normally replaced. If any of these wafers are defective, the entire switch should be replaced. It can be ordered through your Tektronix Field office, either unwired or wired, as desired. Refer to the Electrical Parts List to find the unwired or wired switch part numbers.

#### CAUTION

When disconnecting or connecting leads to a wafer-type switch, do not let solder flow around and beyond the rivet on the switch terminal. Excessive solder can destroy the spring tension of the contact.

### TROUBLESHOOTING

Attempt to isolate trouble to one circuit through operational and visual checks. Verify that the apparent trouble is actually a malfunction within the Type 491 and not improper controls setting or malfunctioning associated equipment. Note the effect the controls have on the trouble symptoms. Normal and abnormal operation of each control helps establish the location and nature of the trouble. Control functions are described in the Operations section.

Check the instrument calibration or the calibration of the affected circuit. The trouble may be corrected after calibration. The calibration procedure is given in Section 6. Before changing any adjustment settings during this check, note the position of the adjustment, so it can be returned to its original position after the check. This will facilitate recalibration after the trouble has been found and corrected.

Check circuit voltages and waveforms against those shown in section 9 of the manual. Fig. 4-22 through 4-26 provide board wiring drawings and component layout information. It is usually best, if the trouble is not isolated to a circuit,

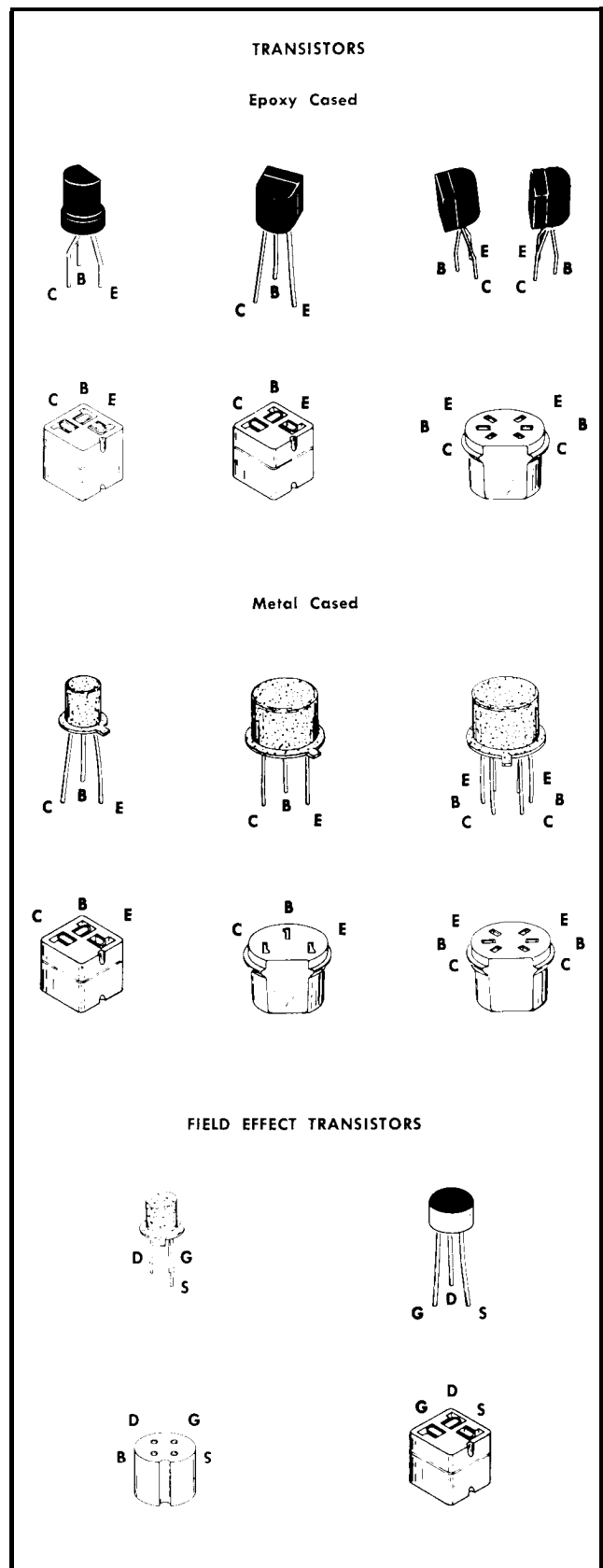

Fig. 4-21. Electrode configuration for socket-mounted transistors and field effect transistors.

to start with the power supply circuit, then proceed consecutively from one circuit to the next.

Once the circuit has been isolated, refer to the Circuit Description in section 3 for a description of the normal circuit operation.

#### CAUTION

Use care when measuring voltages or waveforms. The small size and high density of components in this instrument establishes a condition such that an inadvertent movement of the test probe or the use of oversized probes may short-circuit between components.

The pin connectors to the circuit boards provide a method to isolate circuit resistance and voltages. Check circuit conditions before disconnecting voltages to make certain bias voltages are not removed, which may cause excessive overloads.

### Transistor Substitution and Replacement

Transistors should not be replaced unless they are actually defective. However, temporary substitution is often a con-

venient way to detect defective transistors. Before substituting a transistor, it is recommended that circuit conditions be checked to be certain that an exact replacement will not be damaged. If a transistor is removed from its socket, make certain it is replaced in the same socket in the same position. Some transistors can be inserted incorrectly into their socket. Fig. 4-21 shows the correct connections and positions for the different types of transistors used in the Type 491.

### In-Circuit Diode Checks

In-circuit diode checks may be performed with a voltmeter. A comparison check of the voltages on each side of the diode with the typical voltages listed on the diagram will help isolate faulty diodes. Forward-to-back resistance ratios on some diodes can be checked by referring to the schematic and pulling appropriate transistors and square pin connectors to remove low resistance loops around the diode.

#### CAUTION

Do not use an ohmmeter scale that has a high internal current. Do not check the forward-to-back resistance ratios of tunnel diodes or mixer diodes.

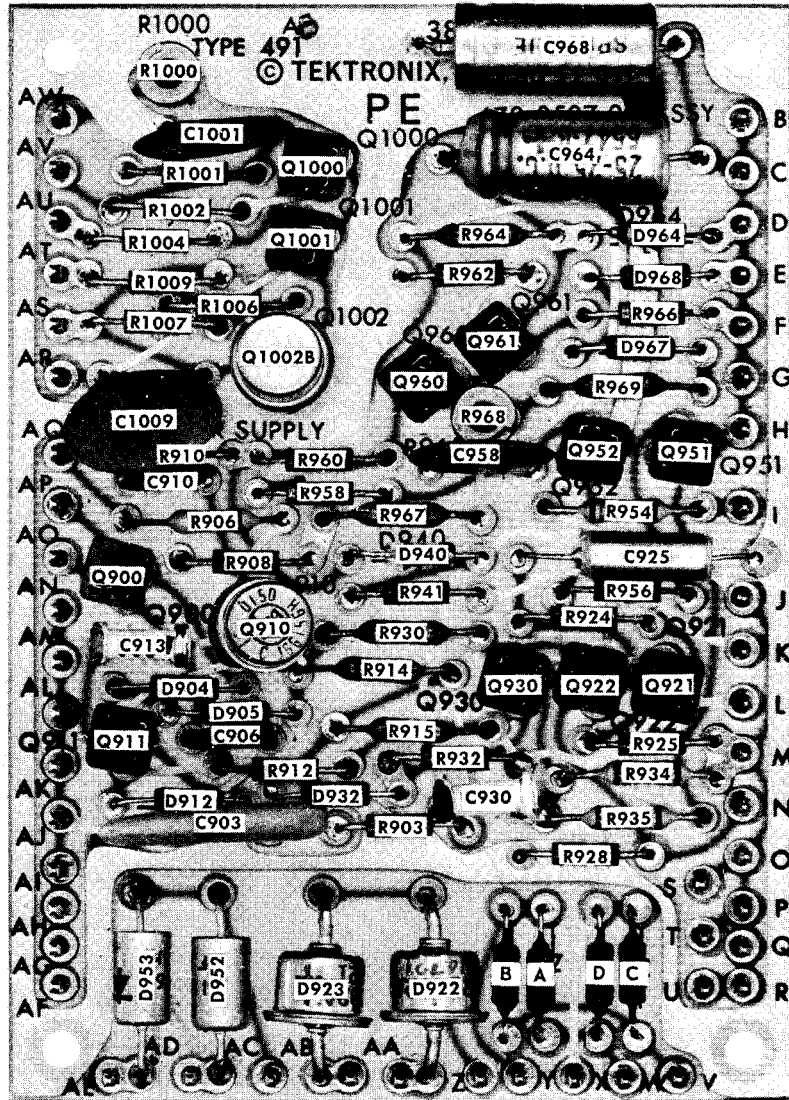

Fig. 4-22. Power supply board assembly with component call out.

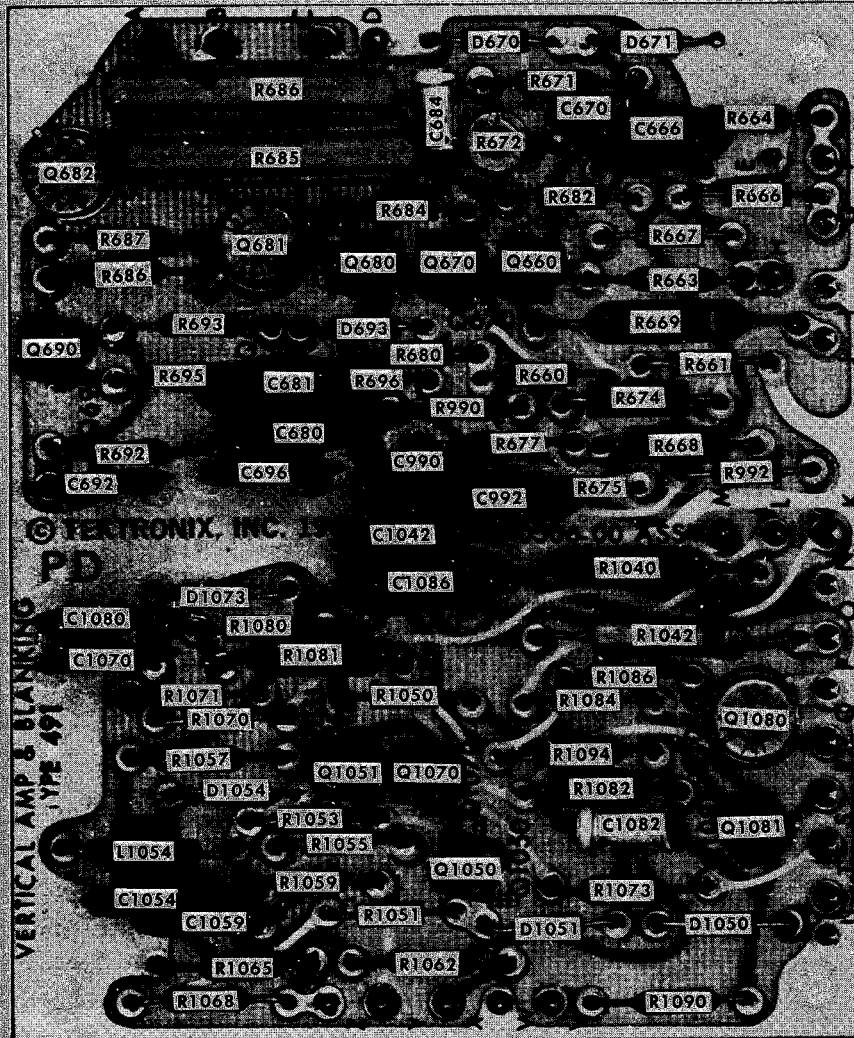

Fig. 4-23 Vertical Amplifier and Blanking board assembly with component call out.



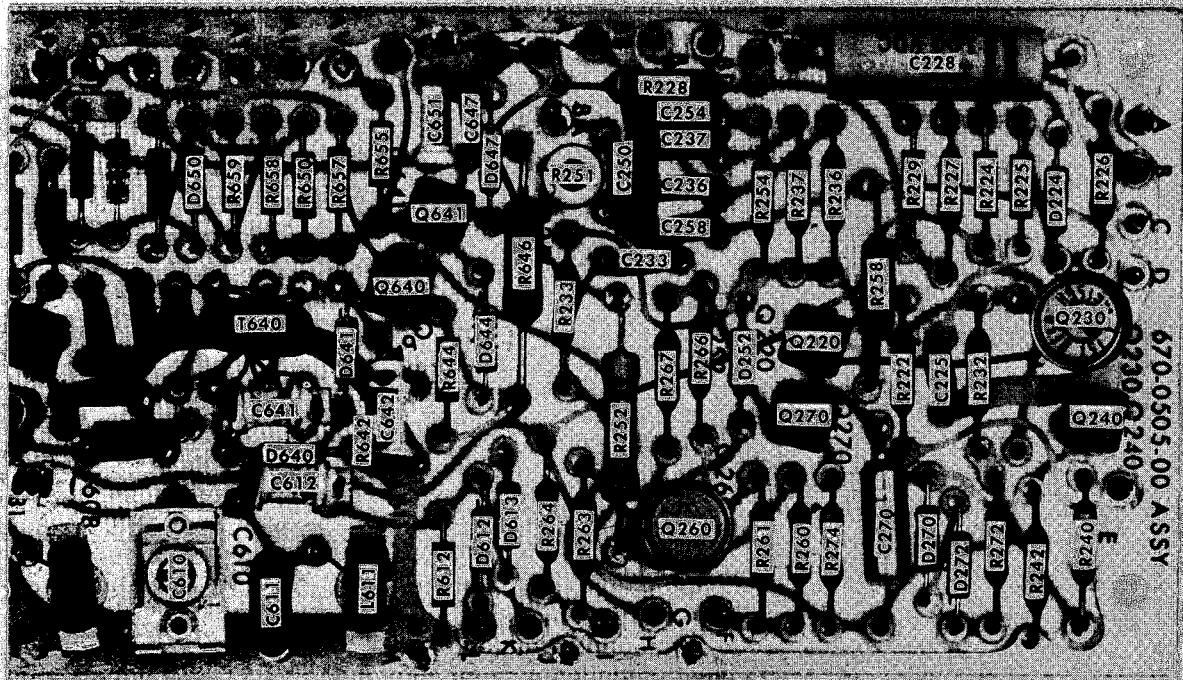

Fig. 4-24. IF control board assembly with component call out.





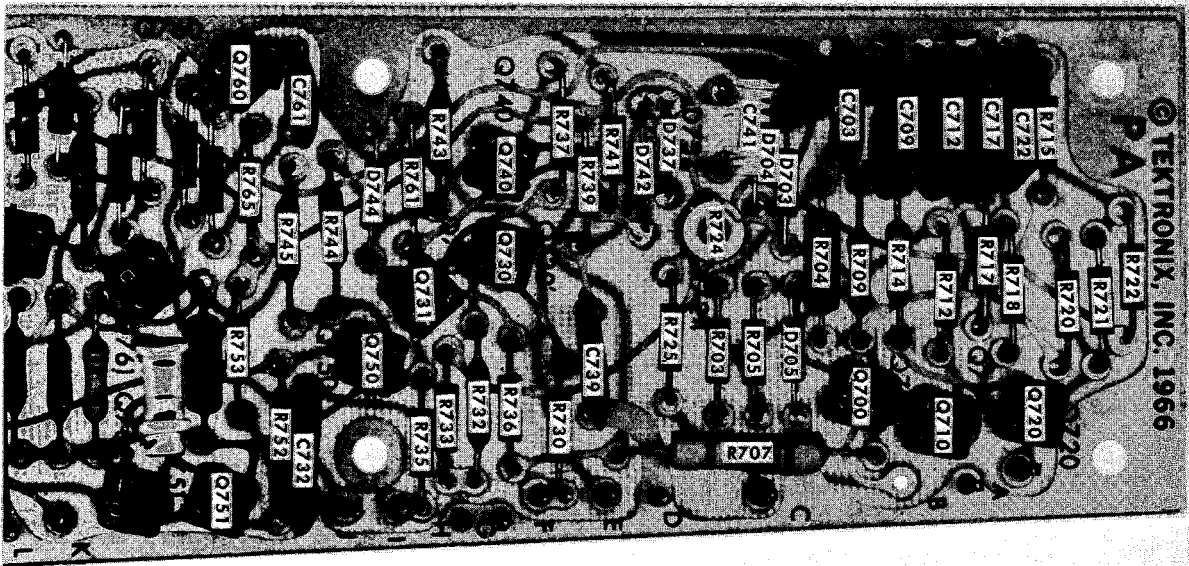

Fig. 4-25. Horizontal display board with component call out.



# SECTION 5

## PERFORMANCE CHECK

This section of the manual provides a means of checking the performance of the Type 491. It is intended to check the calibration of the instrument without performing the complete Calibration Procedure. The Performance Check does not include the adjustment of any internal controls. Failure to meet the requirements given in this procedure indicates the need for internal checks or adjustments, details of which will be found in the Calibration Procedure.

### Recommended Equipment

The following equipment is recommended for a complete performance check. Specifications given are the minimum necessary to perform this procedure. All equipment must be calibrated and operating within the original specifications. If equipment is substituted, it must meet or exceed the specifications of the recommended equipment.

For accuracy and convenience, special calibration fixtures may be used in this procedure. These fixtures are available from Tektronix, Inc. Order by part number through your local Tektronix Field Office or representative.

1. Test Oscilloscope: Minimum deflection factor, .01 volts/division. Frequency response DC to 10 MHz. Any Tektronix oscilloscope and plug-in unit with the above requirements and a 1x and a 10x probe such as P6010 (10x) and P6011 (1x).

2. Time-Mark Generator. Marker outputs, .5s to .1  $\mu$ s and frequency outputs of 20 MHz, 50 MHz, 100 MHz and 200 MHz; accuracy 0.001%. Tektronix Type 184 Time-Mark Generator,

3. Audio Signal Generator: Frequency range 10 Hz to 1 MHz, variable output amplitude at least 10 volts peak to peak, accuracy  $\pm 3\%$ . General Radio Model 1310A or Hewlett-Packard Model 241A.

4. VHF Signal Generator: Frequency range 10 MHz to 400 MHz, accuracy  $\pm 1\%$ , calibrated variable output 0 to -120 dBm. Hewlett-Packard Model 608D.

5. Constant Amplitude Signal Generator: 1 MHz to 10 MHz, output amplitude 1 V to 5 V peak to peak. Tektronix Type 191 Constant Amplitude Signal Generator.

6. Step Attenuators: 1 dB and 10 dB steps, accuracy  $\pm 1.5$  dB to 90 dB (below 1 GHz). Hewlett-Packard Type 355C and 355D Step Attenuators.

7. Harmonic Generator: Tektronix Calibration Fixture 067-0594-00.

8. 200 MHz Trap: Tektronix Calibration Fixture 067-0595-00.

9. Two (2) GR to BNC male adapters: Tektronix Part No. 017-0064-00.

10. Clip lead adapter, BNC. Tektronix Part No. 013-0076-00.

11. Termination, 50  $\Omega$ , BNC. Tektronix Part No. 017-0049-01.

12. BNC T connector. Tektronix Part No. 103-0030-00.

13. Two (2) BNC coaxial cables, 50 W. Tektronix Part No. 012-0057-00.

14. 10 dB attenuator pad,<sup>1</sup>Type N fitting. Tektronix Part No. 011-0085-00.

15. 20 dB attenuator pad,<sup>1</sup>Type N fittings. Tektronix Part No. 011-0086-00.

16. 40 dB attenuator pad,<sup>1</sup>Type N fittings. Tektronix Part No. 011-0087-00.

17. Two (2) adapters, BNC male of N female.<sup>1</sup>Tektronix Part No. 103-0058-00,

18. Two (2) adapters, BNC female to N male.<sup>1</sup>Tektronix Part No. 103-0045-00.

The following additional equipment is required to check the instrument sensitivity, flatness and dial calibration.

#### Group II (optional)

Swept-Frequency Generator, with a frequency range 130 MHz to 280 MHz and an amplitude variation which is less than 0.25 dB, Suggested equipment-Kay Type 121 C Multi-Sweep Generator.

#### Group III

RF Signal Generators with calibrated frequency and output power: Frequency range 10 MHz to 40 GHz, accuracy  $\pm 1\%$ ; output power -100 dBm to -30 dBm, accuracy  $\pm$  dB/dB; output impedance 50  $\Omega$ . Suggested equipment:

Hewlett-Packard 612A UHF Signal Generator, 450 MHz to 1230 MHz.

Hewlett-Packard 8614A UHF Signal Generator, 800 MHz to 2400 MHz.

Hewlett-Packard 8616A UHF Signal Generator, 1800 MHz to 4500 MHz.

Polarad 1107 Microwave Signal Generator, 3.8 GHz to 8.2 GHz.

Polarad 1108 Microwave Signal Generator, 6.95 GHz to 11.0 GHz.

Hewlett-Packard 626A SH F Signal Generator, 10.0 GHz to 15.5 GHz.

Hewlett-Packard 628A SHF Signal Generator, 15.0 GHz to 21.0 GHz.

Hewlett-Packard 938 Frequency Doubler set, 18.0 GHz to 26.5 GHz.

Hewlett-Packard 940 Frequency Doubler set, 26.5 GHz to 40.0 GHz.

Hewlett-Packard X281 Wave-guide to coaxial adapter.

Hewlett-Packard NP292A Wave-guide to coaxial adapter.

<sup>1</sup>Supplied with accessories kit.

Hewlett-Packard MX292B Wave-guide to coaxial adapter.  
 Hewlett-Packard MP 292B Wave-guide to coaxial adapter.  
 Hewlett-Packard NK292A Wave-guide to coaxial adapter.  
 Hewlett-Packard 11503A flexible wave-guide.  
 Hewlett-Packard 11504A flexible wave-guide,

RF Band Selector	A
FINE RF CENTER FREQ	Centered (5 turns from either extreme)
MIXER PEAKING	Search
Phase Lock Controls	
INT REF FREQ	OFF

## PERFORMANCE CHECK PROCEDURE

### General

In the following procedure, test equipment connections or control settings should not be changed except as noted. If only a partial check is desired, refer to the preceding step(s) for setup information.

The following procedure uses the equipment listed under Recommended Equipment. If substitute equipment is used, control settings or setup must be altered to the requirements of the equipment used.

Several checks use a 200 MHz signal applied to the RF INPUT connector. This IF feedthrough signal is not tunable with the RF center frequency. To avoid interference from other signals it is recommended that the tunable signals be positioned off the screen with the RF CENTER FREQUENCY control.

### Preliminary Procedure

Connect the instrument to a power source within the regulating range of the Type 491. Turn the POWER switch to ON and allow at least 20 minutes warm up time at 25° C ±5° C before checking the instrument to given accuracy.

Set the front panel controls as follows:

INTENSITY	Nominal brightness
FOCUS and ASTIGMATISM	Adjusted for a sharply focused display
POSITION	Position the trace to the bottom graticule line and center horizontally
TIME/DIV	1 ms
VARIABLE	CAL
SLOPE	+
LEVEL	FREE RUN
SOURCE	INT

#### Dispersion Controls

DISPERSION RANGE	MHz/DIV
DISPERSION-COUPLED RESOLUTION	10 (MHz/div)
IF ATTENUATOR dB	All switches OFF

#### IF CENTER FREQ Controls

IF CENTER FREQ	Midrange (000)
FINE	Midrange
VIDEO FILTER	OFF
VERTICAL DISPLAY	LIN

### 1. Trace Alignment

a. Requirement—Horizontal trace alignment is not critical and is usually set to the operator's requirement. If misalignment is excessive (approximately 2°) refer to the Calibration Section.

### 2. Astigmatism

a. Requirement—Well defined display with equally focused vertical and horizontal segments in the display.

b. Adjust the GAIN control for a display with approximately 1 division of noise.

c. Adjust the FOCUS control for optimum focus, then adjust the ASTIGMATISM control for optimum vertical definition. Display should be well defined with optimum setting of the FOCUS control.

### 3. Scale Illumination

a. Requirement—Graticule scale illumination must vary smoothly from no illumination with the SCALE ILLUM control fully counterclockwise to maximum illumination with the control fully clockwise.

b. Rotate the SCALE ILLUM control from a fully counterclockwise position to full clockwise.

c. Illumination must increase smoothly as the control is rotated.

### 4. Position Controls

a. Requirement—Vertical POSITION control must position the sweep beyond the upper and lower graticule limits, Horizontal POSITION control must position either end of the sweep into the graticule area.

b. Rotate the Vertical POSITION control to both extremes. Note that the range of the control equals or exceeds the requirements in step a.

c. Rotate the Horizontal POSITION control to both extremes. Note that the range of the control equals or exceeds the above requirements.

### 5. Check Sweep Length

a. Requirement—Sweep Length must equal 10.5 divisions ±0.2 divisions.

b. Check the above requirements for the sweep length.

## 6. Check Saw Out Signal Amplitude

- Requirement—SAW OUT signal amplitude is 70 to 90 mV.
- Connect the test oscilloscope probe to the SAW OUT connector on the rear panel of the Type 491. Adjust the test oscilloscope triggering controls for a triggered sweep ramp display.
- Measure the amplitude of the sawtooth waveform. Must measure between 70 and 90 mV.
- Disconnect the test oscilloscope from the SAW OUT connector.

## 7. Check External Triggering

- Requirement—Sweep circuit must trigger on an externally applied signal of 0.2 V within the frequency range of 20 Hz to 100 kHz.
- Apply the output of the Audio Signal Generator through a coaxial cable and T connector to the rear panel TRIG IN connector. Monitor the applied signal with the test oscilloscope by connecting a coaxial cable between the T connector and the oscilloscope vertical input connector.
- Set the Signal Generator frequency to 20 Hz and adjust the output control for a signal amplitude of 0.2 V peak to peak.
- Change the Type 491 SOURCE switch to EXT position. Adjust the LEVEL control and check for a triggered sweep with the SLOPE switch in either the + or - positions. Must trigger with a 20 Hz, 0.2 V externally applied signal.
- Change the Signal Generator frequency to 100 kHz and adjust the output control for a 0.2 volt peak to peak signal.
- Adjust the LEVEL control and check for a triggered sweep with the SLOPE switch in either the + or - positions. Must trigger with a 100 kHz, 0.2 volt signal.
- Remove the externally applied signal and T connector from the Type 491 TRIG IN connector.

## 8. Check Line Triggering

- Requirement—Sweep will trigger on LINE with the LEVEL control centered and the SLOPE switch in either position.
- Set the SOURCE switch to LINE position.
- Check for a triggered sweep with the LEVEL control centered and the SLOPE switch in either the + or - positions.

## 9. Check Sweep Timing

- Requirement—Sweep timing accuracy must be within  $\pm 3\%$  of indicated TIME/DIV selector Position.
- Apply 10 ns and 1 ms time markers from the Time-Mark Generator through 40 dB attenuator to band A, RF INPUT connector. Set the front panel controls as follows:

DISPERSION RANGE	kHz/DIV
DISPERSION	100 kHz/div
RESOLUTION	100 kHz (fully cw)
IF ATTENUATOR	OFF
VERTICAL DISPLAY	LIN
Band Selector	A
TIME/DIV	1 ms
VARIABLE	CAL
SOURCE	LINE
LEVEL	Triggered sweep

- Adjust the GAIN control for a signal amplitude of approximately 6 divisions.
- Decrease the DISPERSION to 0, keeping the signal centered on screen with the IF CENTER FREQ controls.
- Switch the SOURCE switch to INT position and adjust the LEVEL control for a triggered display.
- Adjust the position control to position the 1st marker to the 1st graticule line (see Fig. 5-1), then check the sweep timing for each position of the TIME/DIV selector. Marker input, TIME/DIV selector and type of display is listed in Table 5-1.

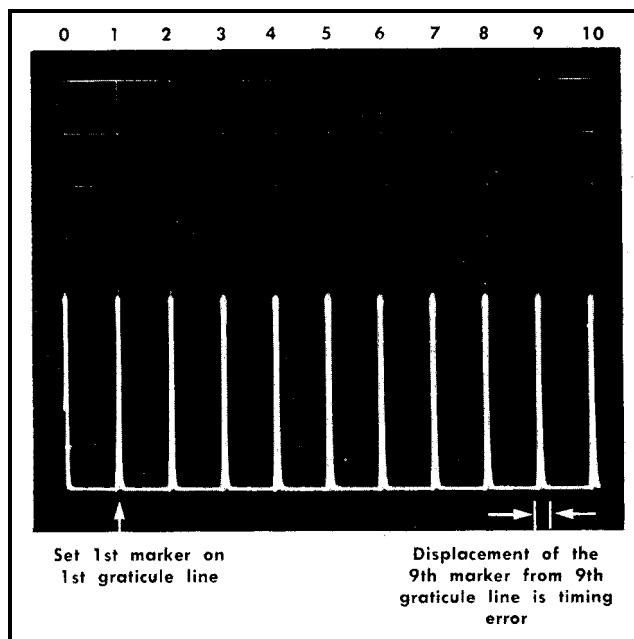

Fig. 5-1. Time markers aligned to check sweep timing.

- Return the TIME/DIV selector to 1 ms position, then apply 10 ns and 5 ms markers to the Type 491.
- Turn the VARIABLE control fully counterclockwise.
- Check—A minimum of five (5 ms) markers should be displayed within the 10 division graticule width. Variable control range 2.5:1.
- Return the VARIABLE control to the CAL position.

TABLE 5-1

TIME/DIV	Time Marker Selector	Display (marker/div)
1 ms	10 ns & 1 ms	1
2 ms	10 ns & 1 ms	2
5 ms	10 ns & 5 ms	1
10 ms	10 ns & 10 ms	1
20 ms	10 ns & 10 ms	2
50 ms	10 ns & 50 ms	1
.1 s	10 ns & .1 s	1
.2 s	10 ns & .1 s	2
.5 s	10 ns & .5 s	1
.5 ms	10 ns & .5 ms	1
.2 ms	10 ns & .1 ms	2
.1 ms	10 ns & .1 ms	1
50 μs	10 ns & 50 μs	1
20 μs	10 ns & 10 μs	2
10 μs	10 ns & 10 μs	1

10. Check Internal Triggering

- a. Requirement-Sweep must trigger on 0.2 division signal amplitude.
- b. With 1 ms and 10 ns markers applied as in step 8, adjust the Trigger LEVEL control for a triggered display on the INT position.
- c. Decrease the amplitude of the displayed markers by switching in 20 dB attenuation and adjusting the GAIN control until sweep triggering can no longer be maintained with optimum adjustment of the LEVEL control.
- d. Check-Amplitude of the markers must be equal to or less than 0.2 divisions (1 minor division).

11. Check IF Center Frequency

- a. Requirement-The center frequency of the IF band-pass with the IF CENTER FREQ controls centered must be adjustable to 200 MHz with the IF CENTER FREQ CAL adjustment.
- b. Apply a calibrated 200 MHz signal from the Time-Mark Generator (Type 184) to band B RF INPUT connector through a 20 dB attenuator pad. (Signal input to the Type 491 should be less than -30 dBm to reduce the number of spurious signals.)
- c. Set the Type 491 front panel controls as follows:

POSITION	Position the trace to the bottom graticule line
IF CENTER FREQ	Centered (000)
FINE IF CENTER FREQ	Centered
DISPERSION RANGE	MHz/DIV
DISPERSION-COUPLED RESOLUTION	10 MHz/div
RF INPUT Selector	B

- d. Adjust the GAIN control for a signal amplitude of 6 divisions.
- e. Adjust the IF CENTER FREQ CAL for minimum signal shift as the DISPERSION control is rotated between 10 MHz/div and .2 MHz /div.
- f. Position the IF feedthrough signal to the center of the graticule with the Horizontal POSITION control.
- g. Set the DISPERSION control to the .2 MHz/div position.
- h. Adjust the DISPERSION BAL for minimum signal shift as the DISPERSION RANGE is switched between MHz and kHz positions. Set the DISPERSION RANGE to kHz.
- i. Adjust the IF CENTER FREQ CAL for minimum signal shift as the DISPERSION control is switched between 100 kHz/div and 1 kHz/div positions.
- j. Check-There should be less than ±2 major division signal shift as the DISPERSION control is rotated down to the 1 kHz/div position. The IF CENTER FREQ CAL adjustment should not be against the stop.

- k. Return the DISPERSION RANGE to MHz position and the DISPERSION-COUPLED RESOLUTION control to 10 MHz/div position.

12. Check the Dispersion Accuracy of the MHz/DIV Ranges and the Range of the IF Center Frequency Control

- a. Requirement-Dispersion accuracy for the MHz/DIV ranges is listed in Table 5-2. IF CENTER FREQ coarse control range should equal or exceed + and - 25 MHz from its centered (000) position. Dispersion accuracy and display linearity must remain within the listed specifications of Table 5-2 to the + and - 25 MHz positions of the control.
  - b. Apply .1μs and 10 ns time markers from the Time-Mark Generator (Type 184) through a 20 dB attenuator to band A RF INPUT connector.
  - c. Set the VERTICAL DISPLAY switch to LOG position. Adjust the GAIN control for a display amplitude of approximately 6 divisions. Set the SOURCE switch to LINE and adjust the LEVEL control for a triggered display.
  - d. Center the IF CENTER FREQ controls.
  - e. Check the dispersion accuracy and linearity for each MHz/DIV setting of the DISPERSION selector as listed in Table 5-2. (See Figs. 5-2 and 5-3.) The Horizontal POSITION control or the IF CENTER FREQ control may be used to align the prime markers to the graticule divisions. As the DISPERSION is decreased, the RESOLUTION control should remain in the coupled position,
  - f. Check the range, dispersion accuracy and linearity of the IF CENTER FREQ control in the 2, 1, .5 and .2 MHz positions of the DISPERSION selector.
- Range of the coarse control should equal or exceed + and - 25 MHz from its centered position. It is checked by rotating the control to both extreme positions from center and noting the frequency shift of the .1μs or 10 MHz markers as the control is rotated. Dispersion accuracy and dis-

play linearity must remain within listed specifications of Table 5-2 to the + and - 25 MHz positions.

g. Center the coarse IF CENTER FREQ control. Set the DISPERSION control to 1 MHz position and apply 10 ns and 1  $\mu$ s markers from the Time-Mark Generator.

h. Check-The range of the IF CENTER FREQ-FINE control. Must equal or exceed + and - 1 MHz.

i. Return the VERTICAL DISPLAY switch to LIN position.

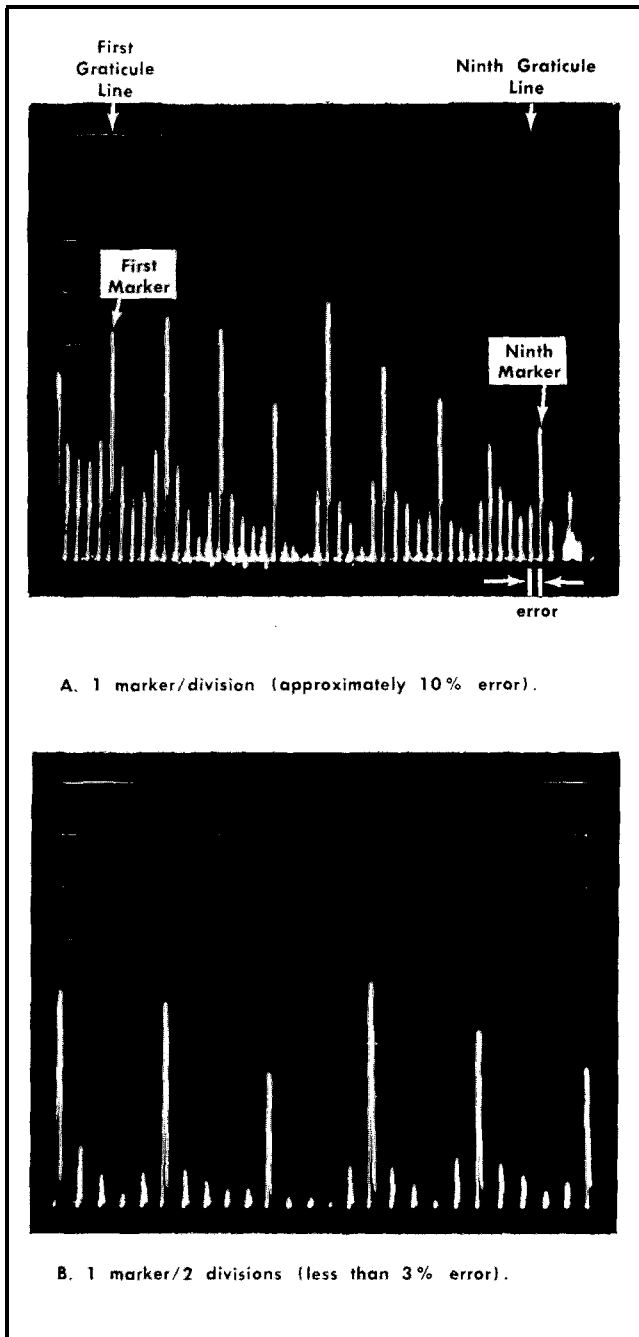

Fig. 5-2. Measuring dispersion accuracy.

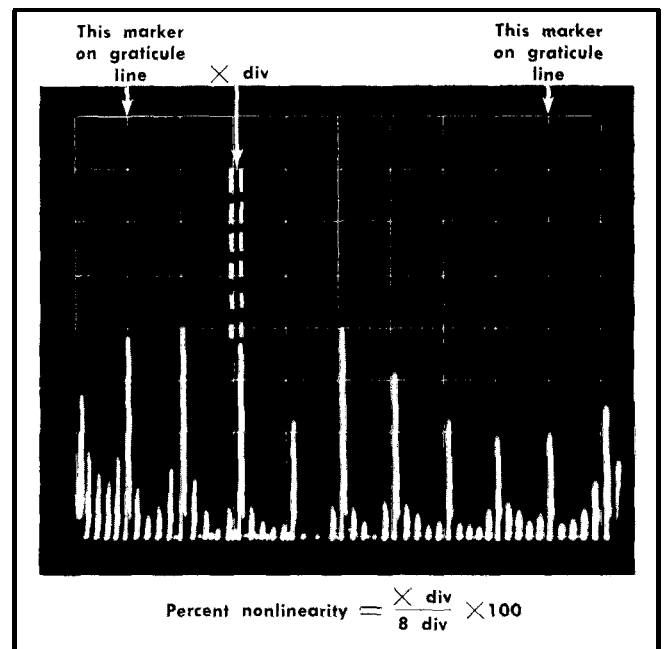

Fig. 5-3. Measuring dispersion linearity.

### 13. Check Resolution Bandwidth

a. Requirement-Resolution bandwidth is equal to or less than 1 kHz, to 100 kHz or more.

b. Apply 200 MHz (5 ns) signal from the Time-Mark Generator to band B RF INPUT connector through 20 dB attenuator. Tune CENTER FREQUENCY control to minimize interference of the converted signals (tunable signals).

c. Set the DISPERSION RANGE to kHz/DIV position and the DISPERSION to 50 kHz/div. Uncouple the RESOLUTION and turn the control fully clockwise. Set the TIME/DW to .1 s.

d. Adjust the GAIN control for an 8 division display amplitude.

e. Check the bandwidth of the 200 MHz signal at the -6 dB amplitude point by switching in -6 dB attenuation with the IF ATTENUATOR switches and noting the -6 dB amplitude point. Bandwidth must equal or exceed 100 kHz. See Fig. 5-4A.

f. Change the RESOLUTION control to 1 kHz position (fully counterclockwise) and the DISPERSION to 1 kHz/div keeping the 200 MHz signal centered on screen with the IF CENTER FREQ controls.

g. Check the resolution bandwidth at the -6 dB amplitude point, Bandwidth must not exceed 1 kHz. See Fig. 5-4B.

h. Return the RESOLUTION to the coupled position and set the DISPERSION-COUPLED RESOLUTION controls to 500 kHz/div position.

TABLE 5-2

DISPERSION Position	Marker Selection	Markers/Div	Allowable Error	Supplementary Notes
10 MHz	10 ns and .1 $\mu$ s	1	$\pm 3\%$	Change allowed with $\pm 10$ MHz change in center frequency, measured over the center 8 div.
5 MHz	10 ns and .1 $\mu$ s	1 marker/ 2 divisions	$\pm 3\%$	Over the range of the IF CENTER FREQ control ( $\pm 25$ MHz). Display linearity over a 8 division display must be within 3%.
2 MHz	10 ns and .5 $\mu$ s	1	$\pm 5\%$	
1 MHz	10 ns and 1 $\mu$ s	1	$\pm 7\%$	
.5 MHz	10 ns and 1 $\mu$ s	1 marker/ 2 divisions	$\pm 10\%$	
.2 MHz	10 ns and 5 $\mu$ s	1	$\pm 15\%$	

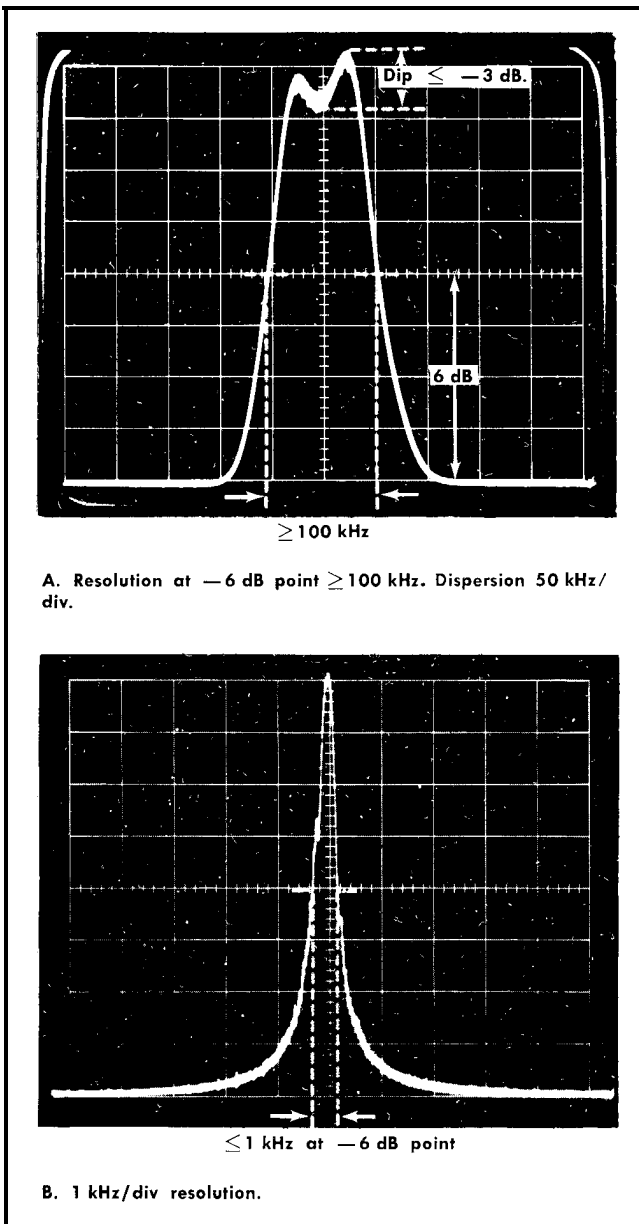

Fig. 5-4. Display pattern when resolution is correctly adjusted.

#### 14. Check Dispersion Accuracy of kHz/div Selections

Requirement: Dispersion accuracy, within 3% over + and - 2.5 MHz range of the IF CENTER FREQUENCY.

a. Apply 10 ns and 1  $\mu$ s markers from the Time-Mark Generator through a 20 dB attenuator to band A, RF INPUT, Set the band selector to A, and the DISPERSION to 500 kHz/div.

NOTE

The marker signals may also be applied through a 20 dB attenuator, a BNC to TNC adapter and the Waveguide Mixer Adapter to band C RF INPUT. (This bypasses the 1st mixer.)

b. Check the range of the IF CENTER FREQ control by rotating the control to the limit each side of center. Count the number of 1 MHz (1  $\mu$ s) markers from the IF feedthrough signal. Must equal or exceed 2.5 MHz, Note the dial reading when the control is 2.5 MHz from center. This reading will be referred to later in the procedure.

c. Center the IF CENTER FREQ controls and change the DISPERSION to 50 kHz/div. Apply 10 ns and 10  $\mu$ s (100 kHz markers) to the Type 491 RF INPUT.

d. Check the range of the IF CENTER FREQ-FINE control. Must equal or exceed 50 kHz either side of center.

e. Center the IF CENTER FREQ controls, change the DISPERSION to 50 kHz/div and again apply 10 ns and 1  $\mu$ s markers to the RF INPUT.

f. Check the dispersion accuracy at each DISPERSION selector position listed in Table 5-3.

Measure dispersion within the center 8 div of the display for each selector position and over the + and - 2.5 MHz range of the IF center frequency. Check accuracy with the IF CENTER FREQ control centered then rotate the control to the dial reading noted in step b at 2.5 MHz and recheck dispersion accuracy.



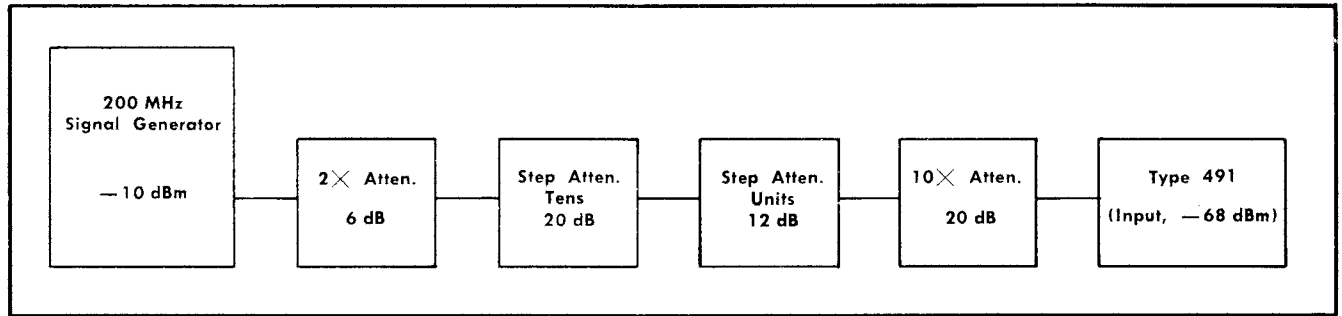

Fig. 5-5 Equipment block diagram showing setup to check attenuator accuracy.

TABLE 5-3

DISPERSION kHz/DIV	Time-Mark Generator Marker Selector	Displays in divisions per marker
500	10 ns and 1 $\mu$ s	2
200	10 ns and 5 $\mu$ s	1
100	10 ns and 10 $\mu$ s	1
50	10 ns and 10 $\mu$ s	2
20	10 ns and 50 $\mu$ s	1
10	10 ns and .1 ms	1
5	10 ns and .1 ms	2
2	10 ns and .5 ms	1
1	10 ns and .5 ms	2

Decrease the sweep rate as the dispersion is decreased and increase resolution by uncoupling the RESOLUTION control and turning it counterclockwise to optimize marker definition. Switch the VERTICAL DISPLAY to LOG and the VIDEO FILTER on, at these slower sweep rates and narrow dispersion selections.

g. Turn the VIDEO FILTER to OFF position and the VERTICAL DISPLAY selector to LIN.

## 15. Check Internal Reference Frequency

a. Requirement-Frequency is 1 MHz  $\pm$ 0.1%, variable frequency range is equal to or greater than 1 kHz, but not over 1.3 kHz, above the measured frequency when the control is in the initial on position.

b. Apply 10 ns and 1  $\mu$ s markers from the Time-Mark Generator to the band B RF INPUT connector through a 20 dB attenuator.

c. Apply the 1 MHz MARKERS OUT signal to band A RF INPUT connector,

d. Set the DISPERSION to 1 MHz/div, the TIME/DIV to 5 ms and the band selector to B.

e. Align the 1  $\mu$ s markers to the graticule lines with the IF CENTER FREQ control. If necessary, adjust the DISPERSION-CAL to calibrate the display. Note the displacement of the 9th time marker at the 9th graticule line.

f. Switch the band selector to A, adjust the GAIN control if required for a satisfactory 1 MHz marker amplitude and turn the RF CENTER FREQUENCY control to align the tunable markers with the fixed markers.

g. Check the frequency of the Internal Reference oscillator by aligning the 1st marker with the 1st graticule line and noting the displacement of the 9th marker from the 9th graticule line. (The INT REF FREQ control must be turned to the initial on position to make this frequency check.) There should be no noticeable difference in the position of the marker with the position noted in step e.

h. Set the DISPERSION RANGE to kHz/DIV and the DISPERSION to 100 kHz/div.

i. Position a 1 MHz marker to the screen center with the IF CENTER FREQ control.

j. Adjust the INT REF FREQ-VARIABLE control through its range and note the frequency shift of the Internal Reference oscillator. The display is the 200th harmonic of the 1 MHz marker signal. The range of the VARIABLE control will also be related to the 200th harmonic, so the marker signal should shift 2 to 2.6 divisions (1 kHz to less than 1.3 kHz).

k. Remove the cable between the 1 MHz MARKERS OUT connector and the RF INPUT connector. Remove the Time-Mark Generator. Set the band selector to C.

## 16. Check Phase Lock Balance Between Band A or B and Band C

a. Requirement-Band A or B, DC output level, with the FINE RF CENTER FREQ control centered, should measure within  $\pm$ 2 divisions of band C, DC output level.

b. With the band selector in position C, push the LOCK CHECK button and position the sweep to the center of the graticule with the FINE RF CENTER FREQ control.

c. Switch the band selector to band A or B and check the position of the trace. Trace position must be within  $\pm$ 2 divisions of the graticule center.

## 17. Check Dynamic Range of Vertical Display Modes

a. Requirement-The dynamic range of the screen for the three display modes is as follows:

LIN;  $\geq 26 \delta B$ .

LOG;  $\geq 40$  dB.

SQ LAW;  $\geq 13 \delta B$

b. Apply 200 MHz signal that has an amplitude less than -40 dBm, from a VHF Signal Generator that has a calibrated variable output attenuator, to band B RF INPUT connector.

c. Adjust the GAIN control and the variable attenuator of the Signal Generator for a display amplitude of 8 divisions (full screen).

d. Increase the output attenuation of the VHF Signal Generator until the signal is just visible (about 0.5 minor division) on the display. Note the difference in the attenuator readings.

e. Check the dynamic range of each VERTICAL DISPLAY switch position. Must equal or exceed the range listed in step a.

f. Return the VERTICAL DISPLAY switch to the LIN position.

### 18. Check Accuracy of IF ATTENUATOR dB Selectors

Accuracy of the IF ATTENUATOR dB selectors is checked at the factory to insure that they are within 0.1 dB/dB specification. Any change in this tolerance should be a large one and due to component failure. Step attenuators with rigid specifications are, therefore, not recommended. However, if the user desires a precise check of the attenuator error, he must either accurately calibrate the recommended equipment or use step attenuators with more rigid specification.

a. Requirement-IF ATTENUATOR selections must remain within 0.1dB/dB.

b. Apply a 200 MHz signal from the signal generator that is 10 dB below 1 mW, through a 2X attenuator (6 dB), a Tens and Units step attenuator and a 10X attenuator (20 dB) to the Type 491 RF INPUT connector. (Fig. 5-5).

c. Set the Tens attenuator for 20 dB attenuation and the Units attenuator for 12 dB attenuation.

d. Adjust the GAIN control for a signal amplitude of 6 divisions on the analyzer screen.

e. Check the accuracy of the IF ATTENUATOR dB selectors as follows:

1. Switch the Type 491 1 dB attenuator switch to ON and switch out 1 dB of attenuation through the units step attenuator.

2. Check the display amplitude. Must equal 6 div.  $\pm 0.7$  minor division (.1 dB/dB).

3. Switch the IF ATTENUATOR switch to OFF position, then check the remaining IF ATTENUATOR switch steps as directed in Table 5-4a.

TABLE 5-4a

Spectrum Analyzer	Step Attenuators		Signal Amplitude Limits (.1 dB/dB)
	Units	Tens	
1 dB	11	20	5.93 to 6.07 div
2 dB	10	20	5.86 to 6.14 div
4 dB	8	20	5.6 to 6.3 div
8 dB	4	20	5.5 to 6.6 div
16 dB	6	10	5.0 to 7.2 div
20 dB	2	10	4.7 to 7.6 div

The 1 and 2 dB measurements are very difficult, because of signal stability and the noise level. For these small signal levels, the square law mode may be used to expand the screen changes, for the same level change by the square power as listed in Table 5-4b.

TABLE 5-4b

dB	1	2	4	8	16	20
Signal Amplitude limits	5.92 to 6.08	5.86 to 6.15	5.4 to 6.6	4.8 to 7.2	3.3 to 8.7	2.5 to 9.5

An alternate method which is not as accurate but is sufficient for most applications is as follows:

1. Apply a 200 MHz signal (at 60 dB below 1 mW, as shown on the Attenuator dial) from the signal generator to the RF INPUT connector. Adjust the Spectrum Analyzer GAIN control for a signal amplitude of 5 divisions.

2. Switch the 1 dB IF ATTENUATOR switch on and adjust the signal generator output attenuator control to return the signal amplitude to 5 divisions.

3. Check the new reading of the attenuator dial. Should read -59 dBm.

4. Turn the 1 dB IF ATTENUATOR switch to OFF. Check the remainder of the IF ATTENUATOR selector steps as directed in Table 5-4c.

TABLE 5-4c

Spectrum Analyzer IF ATTENUATOR	RF Generator Attenuator Control Setting
2 dB	-58 dBm $\pm$ .2 dBm
4 dB	-56 dBm $\pm$ .4 dBm
8 dB	-52 dBm $\pm$ .8 dBm
16 dB	-44 dBm $\pm$ 1.6 dBm
20 dB	-40 dBm $\pm$ 2.0 dBm

### 19. Check Attenuation Range of IF GAIN Control

a. Requirement-The IF GAIN control range should equal or exceed 50 dB.

b. Turn the GAIN control fully counterclockwise. Adjust the VHF Signal Generator output for an 8 division signal amplitude. Note the variable attenuator dial reading.

c. Increase the output attenuation 50 dB from the noted position.

d. Adjust the GAIN control clockwise until the signal amplitude is again 8 divisions. This checks that the range of the control equals or exceeds 50 dB.

## 20. Check INTENSIFIER Control Range

a. Requirement-With the control in the OFF position (fully counterclockwise) the display, plus the baseline, must be intensified. With the control fully on, the baseline plus approximately 30% of the signal should be suppressed.

b. Change the DISPERSION to 100 kHz/div. Uncouple the RESOLUTION control and turn the control fully clockwise.

c. Set the VERTICAL DISPLAY switch to LOG position, then adjust the GAIN control and/or the Signal Generator output for a signal display amplitude of 8 divisions.

d. Turn the INTENSIFIER control to the OFF position, adjust the INTENSITY control for a display of nominal brightness. Set the CONTRAST to midrange. Note that the entire display is intensified.

e. Turn the INTENSIFIER control full on or clockwise.

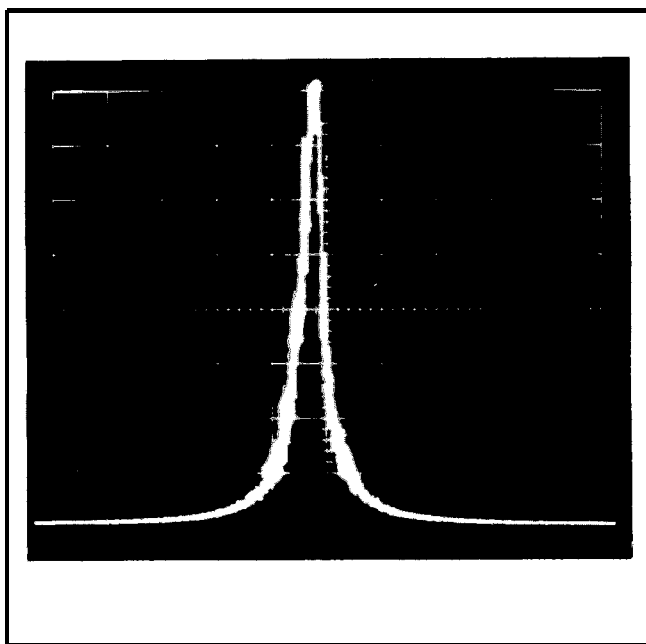

Fig. 5-6. Typical display showing incidental frequency modulation. Measure the horizontal displacement of the signal at the most vertical slope of the signal.

f. Check-The remaining intensified portion of the signal should measure between 3 and 5 divisions.

## 21. Check Signal Amplitude at the TO RECORDER Connector

a. Requirement-Signal amplitude at the TO RECORDER output connector should equal or exceed 4 mV per division of displayed signal amplitude when terminated into a 600 ohm load.

b. Set the VERTICAL DISPLAY switch to LIN, adjust the Signal Generator output and the Type 491 GAIN control for a signal amplitude of 6 divisions.

c. Connect the TO RECORDER connector on the back panel to the Vertical Input of a test oscilloscope through a 1x probe. Terminate the connector into a 600  $\Omega$  load by connecting a 600  $\Omega$  resistor from the TO RECORDER jack to chassis ground.

d. Check-Signal amplitude at the TO RECORDER connector should equal or exceed 24 mV ( $\geq 4$  mV/div).

## 22. Check Incidental Frequency Modulation

a. Requirement-With the DISPERSION RANGE at kHz/DIV the IF incidental FM should not exceed 200 Hz. The incidental FM of the local oscillator plus the IF with phase lock must not exceed 300 Hz.

### NOTE

Signal source must supply a very stable signal to accurately measure this performance and the Type 491 must be on a stable, vibration-free platform. Incidental FM measurements for bands B and C must be performed with the MIXER PEAKING adjusted to maximize signal amplitude for each display window.

b. Set the DISPERSION RANGE switch to kHz/DIV and the DISPERSION to 500 kHz/div. Set the TIME/DIV to .1 s.

c. Apply a 200 MHz signal from the Time-Mark Generator through a 20 dB attenuator to band A RF INPUT connector and center the IF feed-through signal on screen.

d. Change the DISPERSION-COUPLED RESOLUTION to 1 kHz/div, adjusting the IF CENTER FREQ control to keep the signal centered on screen.

e. Adjust the GAIN control for an 8 division signal amplitude,

f. Check the amount of signal frequency modulation (see Fig. 5-6). Must not exceed 1 minor division. ( $\leq 200$  Hz).

g. Change the DISPERSION to 100 kHz/div and move the IF feedthrough signal off screen with the IF CENTER FREQUENCY control. Center a tunable 200 MHz signal on screen with the RF CENTER FREQUENCY controls. Adjust the MIXER PEAKING control for maximum signal amplitude.

h. Turn the INT REF FREQ on and phase lock the display. See operating instructions.

i. Decrease the DISPERSION to 1 kHz/div, keeping the phase locked signal on screen with the IF CENTER FREQ controls.

j. Check the amount of frequency modulation in the display. Must not exceed 1.5 minor divisions (300 Hz).

k. Return the DISPERSION-COUPLED RESOLUTION controls to 500 kHz/div.

## 23. Check Display Flatness

a. Requirement-Display flatness with the IF CENTER FREQ controls centered, is 3 dB maximum amplitude variation

from 10 MHz to 12.4 GHz over 50 MHz dispersion on band A and over 100 MHz dispersion for bands B and C to 12.4 GHz. 6 dB maximum amplitude variation from 12.4 GHz to 40 GHz, over 100 MHz dispersion.

NOTE

Display Flatness check for bands B and C must be made with the MIXER PEAKING control adjusted to maximize signal amplitude for each display window.

b. Set the front panel controls as follows:

DISPERSION RANGE	MHz/DIV
DISPERSION	5 MHz/div
VERTICAL DISPLAY	LIN
IF ATTENUATOR	20 dB
Band Selector	A
TIME/DIV	5 ms

c. Apply the output signal from a signal generator within the frequency range of band A through a 20 dB attenuator, (Part No. 011-0086-00) to the band A RF INPUT connector.

d. Set the generator frequency and the RF center frequency to the frequencies that are listed in Table 5-5. Adjust the signal generator output attenuator and the Type 491 GAIN control for a signal amplitude of 6 divisions.

e. Check band A display flatness by tuning the signal from the left edge to the right edge of the display screen with the RF CENTER FREQUENCY control. (Frequency range + and - 25 MHz from the RF center frequency.) Signal amplitude should not change more than ±1.5 dB from its average amplitude or 3 dB (2.4 div) total.

TABLE 5-5

RF Center Frequency	Applied Signal Generator Freq.
10 MHz- 60 MHz	35 MHz
50 MHz-100 MHz	75 MHz
100 MHz-150 MHz	125 MHz
150 MHz-200 MHz	175 MHz
200 MHz-250 MHz	225 MHz
250 MHz-275 MHz	275 MHz

f. Remove the signal to band A, RF INPUT and apply a signal within the frequency range of band B to RF INPUT B. Set the band selector to B and set the DISPERSION to 10 MHz/div.

TABLE 5-6

RF Center Frequency	Applied Signal Generator Freq.
275 MHz-375 MHz	325 MHz
375 MHz-475 MHz	425 MHz
475 MHz-575 MHz	525 MHz
575 MHz-675 MHz	625 MHz
675 MHz-775 MHz	725 MHz
775 MHz-875 MHz	825 MHz
875 MHz-900 MHz	850 MHz

g. Check display flatness for band B as per Table 5-6. Maximum amplitude variation over 100 MHz window (± 50 MHz from RF center frequency) must not exceed 3 dB. Adjust MIXER PEAKING for maximum signal amplitude before measuring flatness.

h. Remove the signal from band B INPUT and apply the output from signal generators, that cover scales 4 through 6 frequency range, to band B Coaxial Mixer.

i. Check response flatness through the frequency range of the Coaxial Mixer. Maximum amplitude variation over 100 MHz dispersion window must not exceed 3 dB. Adjust MIXER PEAKING for maximum signal amplitude before measuring flatness.

j. Replace the Coaxial Mixer with the Waveguide Mixer Adapter.

k. Apply the output from a signal generator, within the frequency range of scale 8 and 9, through one of the Waveguide Mixers and the 2 foot cable (with TNC connectors) to band C Waveguide Adapter.

l. Check response flatness for the frequency range above 12.4 GHz. Maximum amplitude variation over 100 MHz dispersion window must not exceed 6 dB (+2.4 div, -1.3 div). Adjust MIXER PEAKING for maximum signal amplitude before checking flatness.

m. Remove the Waveguide Adapter and replace the Coaxial Mixer in the band C receptacle.

**24A. Check RF Center Frequency Calibration, System Sensitivity and Phase Lock Operation**

NOTE

Since signal generators with calibrated attenuators are required to check sensitivity, dial accuracy can be checked by the same instruments provided the signal source has an accuracy within 0.1% at the dial check points. The signal generators listed in Table 5-7 may be used if accuracy is checked near each dial check point, by a frequency counter or the beat frequency indicator against some accurate reference frequency.

A secondary or alternate source of accurate frequency markers is the combination of two calibration fixtures (Harmonic Generator 067-0594-00 and a 200 MHz Trap 067-0595-00) and a relatively low frequency, accurate (at least 0.1%), signal source such as a Time-Mark Generator (Type 184).

The harmonic generator will produce sufficient harmonic signal power from the Type 184 to produce frequency markers into the GHz range. The 200 MHz trap attenuates the IF feedthrough spurious response.

This procedure is divided into two steps, with step 24B describing the dial check procedure using the harmonic generator.

a. Requirement-Dial accuracy within  $\pm (2 \text{ MHz} + 1\%$  of dial reading), sensitivity within the specified limits listed in Table 5-7. Phase lock must operate through all frequency ranges.

b. Apply a frequency and amplitude calibrated signal between -60 dBm and -30 dBm, to the RF INPUT connector listed in the Table 5-7. Switch the Type 491 Band Selector to the appropriate band.

c. Set the DISPERSION to 500 kHz/div and the RESOLUTION control for a resolution bandwidth of 100 kHz (fully clockwise).

d. Adjust the GAIN control for an average noise amplitude of one division. Center the IF CENTER FREQ and FINE RF CENTER FREQ controls.

e. Tune the signal on screen with the RF CENTER FREQUENCY control. Reduce the signal amplitude with the signal generator output attenuator control for an on-screen display, then adjust the MIXER PEAKING control and sweep rate for optimum amplitude. (Sweep rate approximately 5 ms/div.)

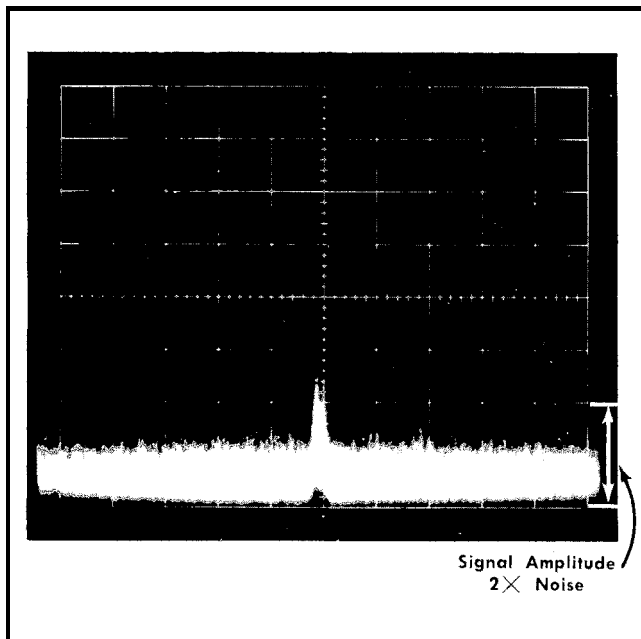

Fig. 5-7. Signal to noise ratio for measuring sensitivity.

f. Calibrate the signal generator output then adjust the variable output attenuator control on the signal generator, until the signal amplitude is two divisions (twice the noise amplitude). See Fig. 5-7.

g. Check the total signal attenuation (in dB) below 0 dBm as indicated on the signal generator attenuator dial. This is the sensitivity of the analyzer for the RF center frequency indicated. Check as listed in Table 5-7 under 100 kHz resolution. Sensitivity can also be checked for 1 kHz resolution; however, a very stable signal source is required at higher frequencies.

NOTE

Cable losses for frequencies of 10 GHz and higher became significant and must be added for correct sensitivity measurements. Refer to Fig. 6-45 for insertion loss of a 6 foot cable.

h. Center the IF CENTER FREQ controls and the FINE RF CENTER FREQ control, then tune the signal to the center of the screen with the RF CENTER FREQUENCY control. (Horizontal sweep must be centered.)

i. Check the dial accuracy as listed in Table 5-7, Must equal or exceed  $\pm (2 \text{ MHz} + 1\%$  of the dial reading).

j. As the dial accuracy is checked, depress the LOCK CHECK button and check for phase lock beats. Check for a phase lock operation at the center and extreme frequency position for each scale. Dial accuracy need only be checked for scales 1, 2 and 4. The remaining scales are harmonic settings of these fundamental frequency ranges,

k. Check phase lock operation with an external reference frequency as follows:

1) Apply a 1 V peak to peak, 1 MHz signal, from the Constant Amplitude Signal Generator (Type 191) to the REF FREQ IN connector, Use a BNC T connector to apply the input signal to the Type 491 to provide a convenient monitoring point for the test oscilloscope. The input signal voltage level must be measured at the REF FREQ IN connector. Turn the INT REF FREQ control to the OFF or EXT REF FREQ IN position,

2) Center the FINE RF CENTER FREQ control. Depress the LOCK CHECK button and adjust the RF CENTER FREQ control until a beat frequency is displayed.

3) Adjust the FINE RF CENTER FREQ control for a LO lock or until the beat reduces to zero (zero beat).

4) Repeat the above procedure with a 5 MHz signal from the signal generator.

5) Increase the input signal amplitude to 5 V peak to peak and repeat the check with the increased signal amplitude at 5 MHz and 1 MHz.

**24B. Alternate Procedure to Check Dial Accuracy, Oscillator and Mixer Operation, and Effectiveness of Local Oscillator Phase Lock**

a. Apply 100 MHz (10 ns) markers from the Time-Mark Generator through a coaxial cable, BNC to GR adapter, Harmonic Generator [calibration fixture 067-0594-00), 200 MHz Trap (calibration fixture 067-0595-00), GR to N type adapter, and the 20 dB RF attenuator (011-0086-00), to the band B RF INPUT.

b. Switch the band selector to B. Set the DISPERSION RANGE to MHz/DIV, and the DISPERSION to 2 MHz/div. Switch the VERTICAL DISPLAY selector to LOG.

c. Check dial accuracy for band B as follows:

1) Tune the RF CENTER FREQUENCY through the band. Observe the 100 MHz harmonics and their image spuri travel

towards the center of the display, merge over the IF feedthrough response than separate and move off the screen, as the center frequency is tuned through 100 MHz check points on the dial. See Fig. 5-8. Error between the dial readings and the frequency check points must not exceed  $\pm (2 \text{ MHz} + 1\% \text{ of the dial reading})$ .

2) Adjust the MIXER PEAKING control to optimize signal amplitude. Note the spectral display of the harmonic generator signals. Tune the RF CENTER FREQUENCY through the band, checking for dead spots which could be caused by either the local oscillator failure or mixer malfunction. The MIXER PEAKING must be peaked at all check points.

d. Check-Local oscillator phase lock operation as follows:

1) Turn the INT REF FREQ control on, Decrease the DISPERSION to 500 kHz/div.

2) Depress the LOCK CHECK button and adjust the FINE RF CENTER FREQ control to position the display to the center of the graticule area. Release the LOCK CHECK button.

3) Shift the IF feedthrough response approximately 2 graticule divisions off center with the IF CENTER FREQ control, then tune the RF CENTER FREQ to any harmonic signal. Depress the LOCK CHECK button and adjust the FINE RF CENTER FREQ control to establish a lock made on the harmonic signal. See Operating instructions.

4) Decrease the DISPERSION to 50 kHz/div, keeping the signal centered on the screen with the IF CENTER FREQ control.

5) Slowly adjust the FINE RF CENTER FREQ control until the LO loses the lock. The signal may shift off screen. Re-establish phase lock by adjusting the FINE RF CENTER FREQ control to return the signal on screen.

6) Slowly adjust the INT REF FREQ, VARIABLE control. Note the signal shift across the dispersion window as the reference oscillator frequency is changed. Range of the control is approximately 0.1% of the dial frequency. See step 15.

e. Remove the signal and harmonic source from band B RF INPUT connector and apply the signals to band C, coaxial mixer. Switch the band selector to C and set the DISPERSION to 2 MHz/div.

f. Check dial accuracy over scale 4, band C. Check oscillator and mixer operation and local oscillator phase lock as the dial accuracy is checked. Check these parameters by repeating the procedure described in steps (d) for band B.

#### NOTE

There is no need to check dial calibration of the upper scales of band C because they are multiples of scale 4.

g. Apply 10 MHz (.1  $\mu\text{s}$ ) marker signals and harmonics to the band A RF INPUT. Switch the band selector to A. Set the DISPERSION to 1 MHz/div.

h. Check the dial accuracy, oscillator and mixer performance, and LO phase lock operation through band A. Check by using the some procedure used to check bands B and C. Note that range of INT REF FREQ control is less because of lower ratio between reference oscillator and LO.

i. Check-Phase lock operation with an external reference frequency. Use the procedure rescribed in step 24A (k).

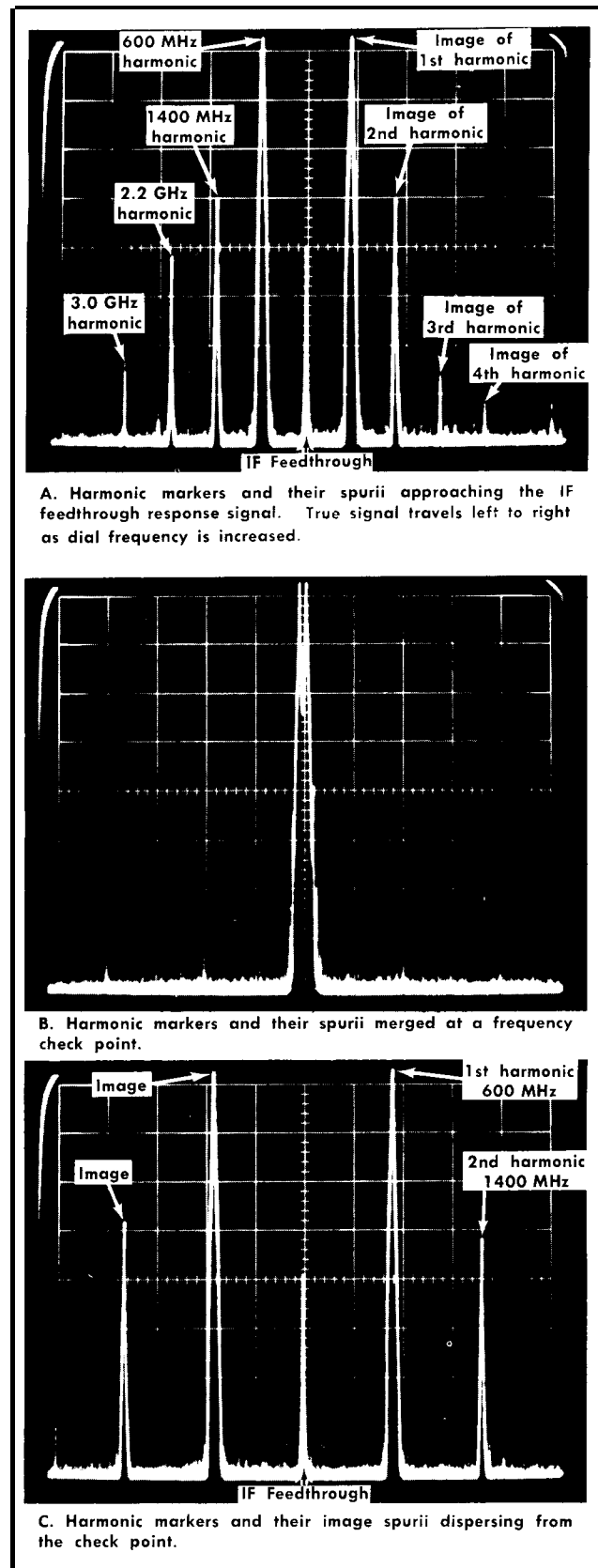

Fig. 5-8. Harmonic frequency markers used to check dial accuracy.

TABLE 5-7

Suggested Signal Generator (Refer to equipment list)	Frequency	Band	Sensitivity (50 W source) Equal to or better than		Dial Accuracy Check Frequency
			100 kHz	1 kHz	
Hewlett-Packard Model 608D	10 MHz	1	-80 dBm	-100 dBm	Every 10 MHz
	140 275				
Hewlett-Packard Model 612A	275 400	2	-90 dBm	-110 dBm	Every 100 MHz
	900				
Hewlett-Packard Model 8614A	850	3	-85 dBm	-105 dBm	Every 500 MHz
	1.5 GHz 2.0				
Hewlett-Packard Model 8616A	1.5	4 <sup>1</sup>	-90 dBm	-110 dBm	Every 1.0 GHz
	2.5 4.0				
Polarad Type 1107	4.0	5 <sup>2</sup>	-80 dBm	-100 dBm	
	6.0 8.0				
Polarad Type 1108 Hewlett-Packard Model 626A	8.0 10.0 12.0	6 <sup>1</sup>	-75 dBm	-95 dBm	
	12.4 15.0				
Hewlett-Packard Model 628A	18.0	7 <sup>2</sup>	-70 dBm	-90 dBm	
	18.0				
Hewlett-Packard Model 938	25.0	8 <sup>2</sup>	-60 dBm	-80 dBm	
Hewlett-Packard Model 940	26.5 40.0	8 <sup>2</sup>	-50 dBm	-70 dBm	

<sup>1</sup>Sensitivity is specified at the mixer input. Insertion loss through the cable, at the higher (GHz) frequency range, will become significant. Fig. 6-45 is a graph that shows the approximate loss in dB for a 6 foot coaxial cable.

<sup>2</sup>When checking the sensitivity of scales 7 and 8, apply the source signal to the Waveguide Mixer, then connect the Waveguide Mixer to the Mixer Adapter through the 2 foot cable with TNC connections.

**25. Check Amplitude of Spurious Signals from Internal Sources**

Requirement-With the DISPERSION RANGE at kHz/DIV for band A, spurious signals must not exceed 2 times noise amplitude. With DISPERSION RANGE at MHz/DIV for bands B and C, spurious signals should be down more than -40 dB with 100 kHz resolution.

b. Connect a 50 W termination on band A RF INPUT connector and switch the band selector to band A.

c. Set the DISPERSION RANGE to kHz/DIV, the DISPERSION to 500 kHz/div and the RESOLUTION control fully clockwise.

d. Adjust the GAIN control for an average noise amplitude of 1 division then tune the RF CENTER FREQUENCY control across the entire band checking that spurious signals

do not exceed 2 divisions in amplitude. (2x average noise level.)

e. Move the 50 Ω termination to band B RF INPUT connector and switch the band selector to band B. Change the DISPERSION RANGE to MHz/DIV and the DISPERSION to 10 MHz/div.

f. Adjust the GAIN control for an average noise level of 1 division, then tune across the entire band, checking for spurious signals greater than 2 divisions in amplitude.

g. Move the 50 Ω termination to band C RF INPUT connector. Change the band selector to band C.

h. Measure band C for spurious signals as above.

This concludes the performance check for the Type 491. If the instrument has met all checks it is ready to operate and will perform to specifications listed in Section 1.





# SECTION 6

## CALIBRATION

### Introduction

This spectrum analyzer is a stable laboratory instrument which should not require frequent recalibration. Performance however, should be checked as directed in Section 5, approximately every 1000 hours of operation or every six months if used intermittently. This assures proper operation or indicates the section of the instrument that needs calibration.

This calibration procedure is arranged so the instrument can be checked and calibrated with the least interaction of adjustments and reconnecting of test equipment. A single step can usually be performed, provided interaction between steps and adjustments is considered.

#### CAUTION

Removing or replacing the dust cover for the instrument may be hazardous. Remove or replace the cover as follows: Place the accessory cover (front) on the instrument. Set the instrument on the front-panel cover (do not set the instrument on the front-panel controls). The dust cover may now be removed or replaced with safety and ease.

### Recommended Equipment

The equipment required to calibrate the Type 491 is listed in three groups: 1. Basic equipment: Check and calibrates the Type 491 except for the following; sensitivity, system flatness, front-end calibration, and the honeycomb assemblies. 2. Equipment required for checking the honeycomb assembly. 3. Equipment required to check the system sensitivity and calibrate the local oscillator and mixer sections.

The calibration of the honeycomb, local oscillator and mixer sections is complex and requires special skills and equipment. We recommend returning these assemblies to Tektronix for recalibration. See the Maintenance section for instructions concerning removal of these assemblies.

Minimum test equipment specifications are listed. If substitute equipment is used, it must meet or exceed specifications of the recommended equipment. Proper dial and equipment setups of the substitute equipment must be determined by the user. Signal generators should be relatively free of harmonic content to provide a clean display.

#### Group 1

1. Test Oscilloscope and Vertical Plug-In Unit with 1x and 10x probes. Minimum sensitivity .005 V/cm, frequency response DC to 30 MHz. Tektronix Type 540 Series oscilloscope with Type 1A1 Plug-In Unit and Tektronix P6010 (10x) and P6011 (1x) test probes.

2. Time-Mark Generator. Marker outputs, .5 s to .1  $\mu$ s and frequency outputs of 20 MHz, 50 MHz, 100 MHz and 200 MHz; accuracy 0.001%. Tektronix Type 184 Time-Mark Generator.

3. Audio Signal Generator. Frequency range 10 Hz to 1 MHz, variable output amplitude to at least 10 volts peak

to peak, accuracy  $\pm 3\%$ . General Radio Model 1310A or Hewlett-Packard Model 241A.

4. VHF Signal Generator. Frequency range 10 MHz to 400 MHz, accuracy  $\pm 1\%$ , calibrated 0 to -120 dBm, variable output. Hewlett-Packard Model 608D.

5. Constant Amplitude Signal Generator. 1 MHz to 10 MHz amplitude 1 V to 5 V peak to peak. Tektronix Type 191 Constant Amplitude Signal Generator.

6. Variable Autotransformer. Voltage range 96 to 137 (192 to 274) volts nominal line. Monitor output voltage with an AC (RMS) voltmeter. General Radio Model W10-MT3W Metered Variac.

7. Multimeter. Minimum sensitivity 20,000  $\Omega$ /volt, accuracy within 1% at 10V, 12V, 125V and 3750V; ammeter range to 1 ampere, Simpson Model 262 or Triplet Model 630-PL.

8. Step Attenuators. 1 dB and 10 dB steps, accuracy  $\pm 1.5$  db to 90 dB (below 1 GHz)<sup>1</sup>. Hewlett-Packard Type 355C and 355D Step Attenuators.

9. Harmonic Generator. Tektronix Calibration Fixture 067-0594-00.

10. 200 MHz Trap. Tektronix Calibration Fixture 067-0595-00.

11. Adapter Cable. BNC female to subminiature female, 4½ inches. Tektronix Part No. 175-0321-00. Subminiature to BNC male, P6041 probe cable, Part No. 010-0164-00.

12. Two (2) GR to BNC male adapters. Tektronix Part No. 017-0064-00.

13. Clip lead adapter, BNC. Tektronix Part No. 013-0076-00.

14. Termination, 50  $\Omega$ , BNC. Tektronix Part No. 017-0083-01.

15. BNC T connector. Tektronix Part No. 103-0030-00.

16. Two (2) BNC coaxial cables, 50  $\Omega$ . Tektronix Part No. 012-0057-00.

17. 10 dB attenuator pad<sup>2</sup>, type N fitting. Tektronix Part No. 011-0085-00.

18. 20 dB attenuator pad<sup>2</sup>, type N fitting. Tektronix Part No. 011-0086-00.

19. 40 dB attenuator pad<sup>2</sup>, type N fitting. Tektronix Part No. 011-0087-00.

<sup>1</sup>Accuracy of the IF ATTN dB selectors is checked at the factory to insure they are within the 0.1 dB/dB specification. Change in this tolerance should be large and due to component failure. Step attenuators with rigid specifications are therefore not recommended, however, if the user desires to precisely check the attenuator error, he must either accurately calibrate the recommended equipment or use attenuators with more rigid specifications.

<sup>2</sup>Supplied with accessories kit.

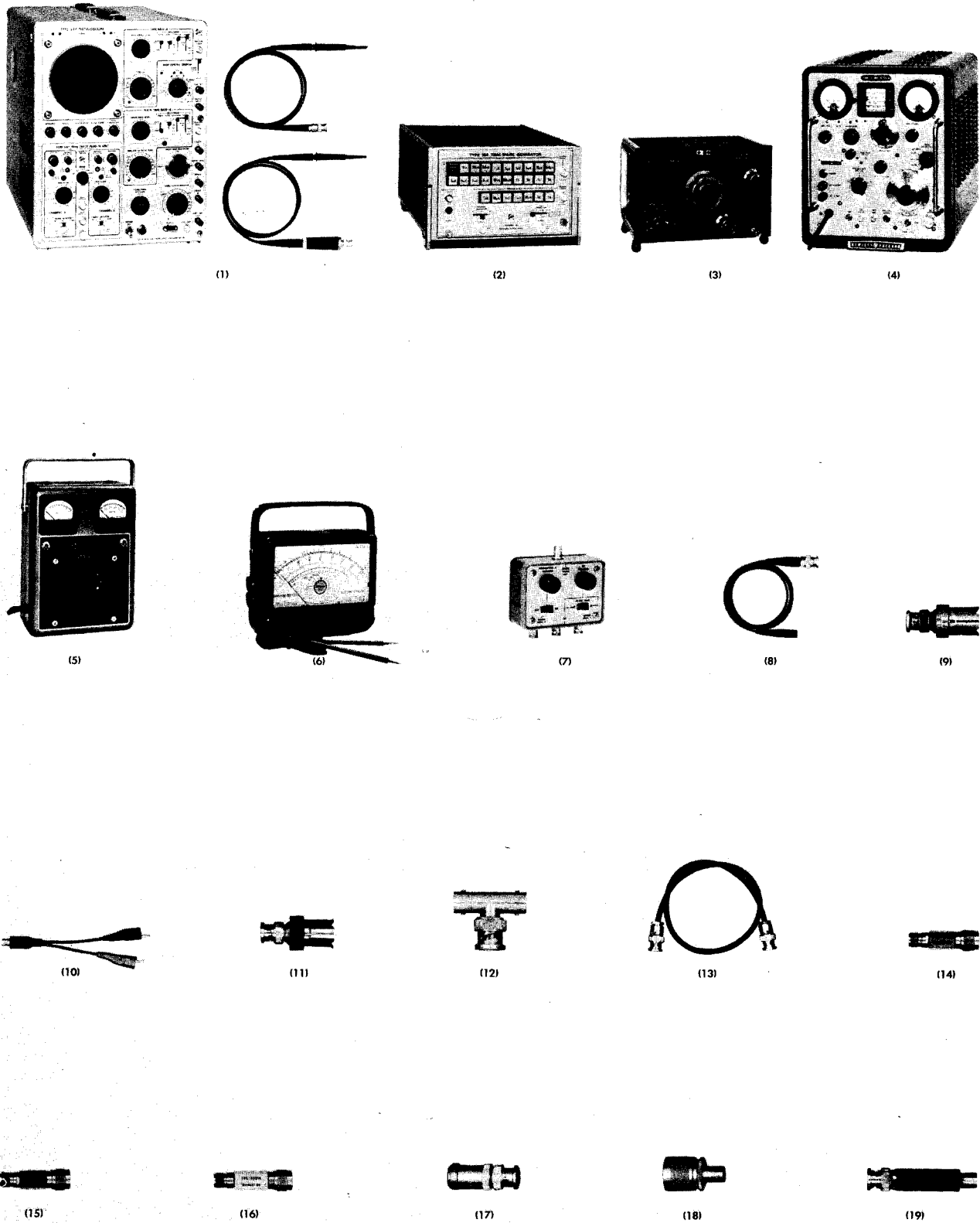

Fig. 6-1. Test equipment recommended for calibration of the Type 491.

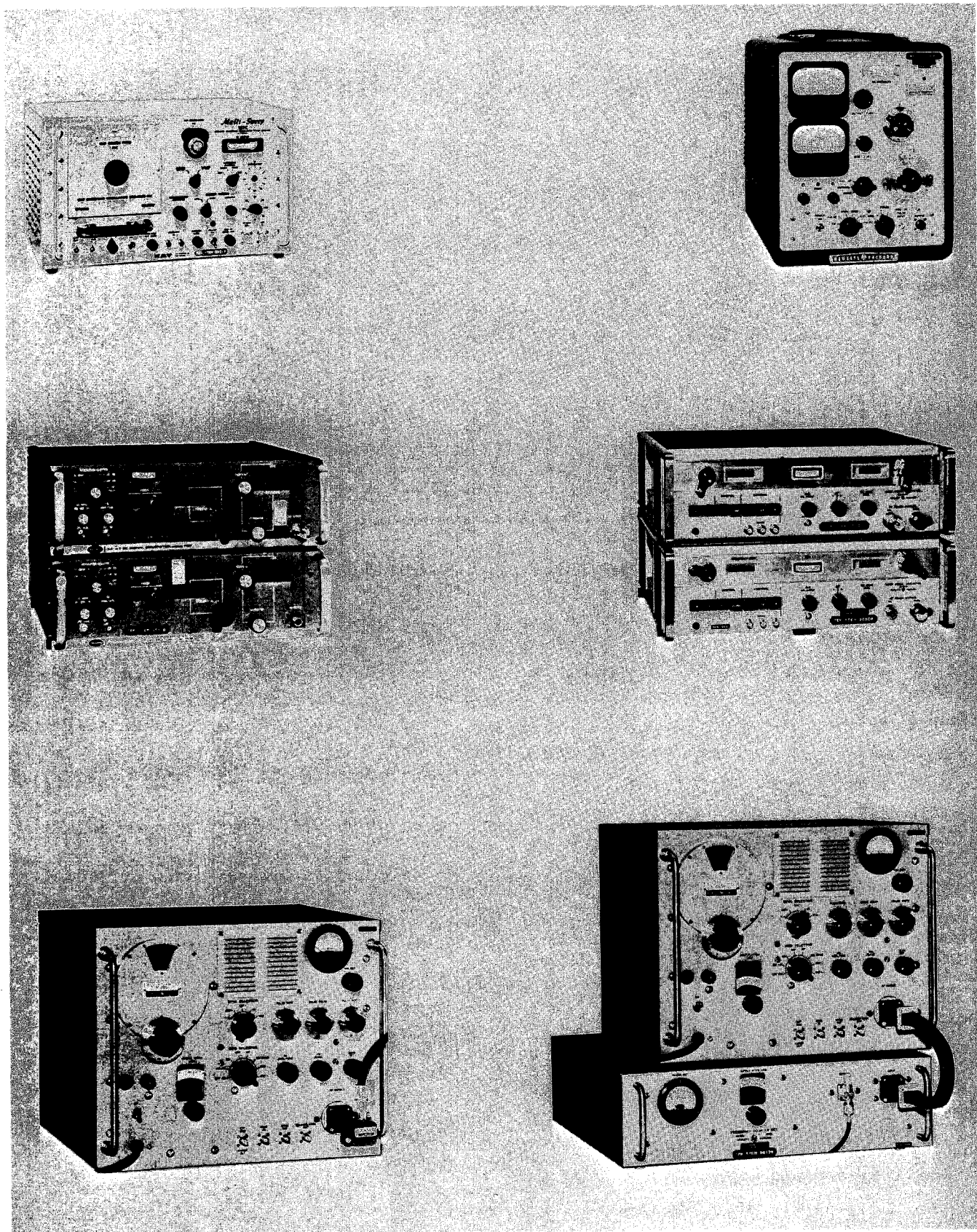

Fig. 6-2. Test equipment recommended to measure the dial accuracy, receiver sensitivity and response flatness.



Fig. 6-3. Recommended adjustment tools.

20. Two (2) adapters, BNC male to N female<sup>2</sup>. Tektronix Part No. 103-0058-00.

21. Two (2) adapters, BNC female to N male<sup>2</sup>. Tektronix Part No. 103-0045-00.

22. 10x attenuator, BNC connector. Tektronix Part No. 011-0059-00.

**Adjusting Tools.** See Fig. 6-3.

- a. Screwdriver,  $\frac{3}{32}$  blade, 3 inch shaft 003-0192-00
- b. Tuning tool
  - Handle 003-0307-00
  - Insert for  $\frac{5}{64}$  (D) hex cores 003-0310-00

**Group II (optional)**

Swept-Frequency Generator, with a frequency range 130 MHz to 280 MHz and amplitude variation less than 0.25 dB. Suggested equipment—Kay Type 121C Multi-Sweep Generator.

**Group III**

RF Signal Generators, with calibrated frequency and output power: Frequency range 10 MHz to 40 GHz, accuracy  $\pm 1\%$ ; output power -100 dBm to -30 dBm, accuracy  $\pm 1$  dB; output impedance 50  $\Omega$ . Suggested equipment:

Hewlett-Packard 612A UHF signal generator, 450 MHz to 1230 MHz.

Hewlett-Packard 8614A UHF signal generator, 800 MHz to 2400 MHz.

Hewlett-Packard 8616A UHF signal generator, 1800 MHz to 4500 MHz.

Polarad 1107 Microwave signal generator, 3.8 GHz to 8.2 GHz.

Polarad 1108 Microwave signal generator, 6.95 GHz to 11.0 GHz.

Hewlett-Packard 626A SHF signal generator, 10.0 GHz to 15.5 GHz.

Hewlett-Packard 628A SHF signal generator, 15.0 GHz to 21.0 GHz.

Hewlett-Packard 938 Frequency doubler set, 18.0 GHz to 26.5 GHz.

Hewlett-Packard 940 Frequency doubler set, 26.5 GHz to 40.0 GHz.

Hewlett-Packard X281 Wave-guide to coaxial adapter.

Hewlett-Packard NP292A Wave-guide to coaxial adapter.

Hewlett-Packard MX292B Wave-guide to coaxial adapter.

Hewlett-Packard MP292B Wave-guide to coaxial adapter.

Hewlett-Packard NK292A Wave-guide to coaxial adapter.

Hewlett-Packard 11503A Flexible wave-guide.

Hewlett-Packard 11504A Flexible wave-guide.

## CALIBRATION RECORD AND INDEX

This Abridged Calibration Procedure is provided to aid in checking the operation of the Type 491/R491. It may be used as a calibration guide by the experienced calibrator, or as a calibration record. Since the step number and titles used here correspond to those in the complete Calibration Procedure, the following procedure serves as an index to locate a step in the complete Calibration Procedure. Characteristics are those listed in the Characteristics section of the instruction manual.

Type 491, Serial No. \_\_\_\_\_

Calibration Date \_\_\_\_\_

Calibrator \_\_\_\_\_

- 1. Adjust the -10 Volt Supply. Page 6-8  
If voltage is not within tolerance ( $\pm 1\%$ ) adjust R968 for -10 volts.
- 2. Check the +10 Volt and +150 Volt Supplies. Page 6-9
- 3. Adjust the High Voltage Power Supply. Page 6-9  
Measure high voltage between pin 14 of CRT and chassis ground.  
Adjust R1000 for 3670 volts.
- 4. Adjust Intensity Range. Page 6-10  
Remove F1008 and connect ammeter across the fuse holder. Adjust R1032 for 750 mA. Be careful not to exceed 800 mA.
- 5. Check Power Supply Voltage Regulation. Page 6-10  
Refer to Table 6-2.
- 6. Adjust Trace Alignment. Page 6-11  
Adjust R1035 to align trace with horizontal graticule line.
- 7. Adjust Vertical Amplifier Gain. Page 6-13  
With 0.5 volt signal applied to pin H of Vertical Amp. board, adjust R873 for 5 division display.
- 8. Check Range of Vertical POSITION control. Page 6-13  
A 0.5 volt signal applied to pin H of the Vertical Amplifier should position out of the graticule area when the Vertical Position control is in either extreme position.
- 9. Adjust Trigger Level Centering. Page 6-14  
Adjust LEVEL control for zero volts at pin C of Horizontal Display board, then adjust Trig Level Center R724, for stable sweep triggering with + and - SLOPE on an internal signal with an amplitude of 0.2 divisions.
- 10. Check External Triggering. Page 6-15  
Check triggering with an externally applied signal with an amplitude  $\geq 0.2$  V and a frequency between 20 Hz and 100 kHz.
- 11. Check Line Triggering. Page 6-16  
Apply the line signal from pin 17 of the power transformer through a 10x attenuator probe, to pin H on the Vertical Amplifier board. Check operation of LINE trigger on + and - SLOPE positions.
- 12. Adjust Sweep Length, Page 6-17  
Adjust Sweep Length R759, for 7.5 volt peak to peak sawtooth, at pin S of the Horizontal Display board.
- 13. Adjust Sweep Calibration and Sweep Gain. Page 6-17  
Adjust Sweep Gain R813, for 10.5 division sweep length. Adjust Sweep Cal R787, for calibrated sweep. Use 1 ms timing markers applied to pin H of Vertical Amplifier board to calibrate sweep timing.
- 14. Check Sweep Timing Accuracy. Page 6-18  
Check sweep timing accuracy ( $\pm 3\%$ ), for all positions of the TIME/DIV selector.
- 15. Check VARIABLE Control Range. Page 6-18  
VARIABLE control range  $\approx 2.5:1$ .
- 16. Check SAW OUT Signal Amplitude. Page 6-18  
Check amplitude of sawtooth signal at SAW OUT connector. Should measure between 70 and 90 mV.
- 17. Check Unblinking Waveform. Page 6-19  
Check unblinking waveform at pin K of Horizontal Display board. Should measure between 0.8 and 1.0 volt, typically 0.9 V.
- 18. Adjust RF Amplitude. Page 6-19  
Adjust the RF Ampl R290, for -0.85 volt  $\pm 0.1$  V at pin, P of square pin connector on the honeycomb assembly.
- 19. Adjust Center Frequency Range. Page 6-19  
Apply 200 MHz to the RF INPUT connector. Adjust Center Freq Range R251, for minimum IF signal shift as the DISPERSION selector is switched through the MH/div range.
- 20. Adjust Sweep Center. Page 6-19  
Apply a 200 MHz signal to the band B RF INPUT connector. Adjust Sweep Center R203, to center the 200 MHz signal on the sweep.
- 21. Adjust MHz/Div Dispersion and Linearity. Page 6-20  
Apply 10 MHz (.1  $\mu$ s) and 10 ns markers to RF INPUT from the Time-Mark Generator. Adjust DISPERSION CAL R208 and C358 for dispersion accuracy and linearity.
- 22. Check Dispersion Accuracy of the MHz/ DIV Ranges and the IF CENTER FREQ Controls. Page 6-22  
Check the dispersion accuracy for each MHz/div position of the DISPERSION selector as listed in Table 6-3.
- 23. Adjust IF Amplifier Response and Resolution Bandwidth. Page 6-23  
Adjust L144, T464, T454, C435, C425 for maximum response to an IF feedthrough signal with the GAIN control fully clockwise. Adjust L444 for stable 70 MHz oscillator operation.  
  
Set the DISPERSION to 50 kHz/div, RESOLUTION fully clockwise, Connect a 10x probe from the test oscilloscope to pin B of the honeycomb assembly. Adjust C504, C508, C601, C604, C607 and C610 for optimum display symmetry and maximum amplitude with no more than 3 dB dip in the center. Set

amplitude with no more than 3 dB dip in the center. Set the RESOLUTION control fully clockwise. Adjust the 100 kHz Resolution Cal R543, for a resolution bandwidth between 100 kHz and 120 kHz at the -6 dB point. Check that the bandpass decreases to less than 1 kHz with the RESOLUTION control in the fully counterclockwise position.

- 24. Adjust the kHz/DIV DISPERSION Calibration. Page 6-25

Apply 10 ns and 1  $\mu$ s markers to the RF INPUT. Set the DISPERSION to 500 kHz/div. Preset the DISPERSION BAL to midrange position. Adjust C384 and C385 for 1 marker per two divisions. Adjust these capacitors simultaneously in opposite directions to keep the 200 MHz signal centered on screen. Adjust kHz/Div Cal R368, for optimum dispersion linearity.

- 25. Check Dispersion Accuracy of the kHz/DIV Ranges. Page 6-26

Apply time markers from the Time-Mark Generator to the RF INPUT as listed in Table 6-4 and check the kHz/div dispersion accuracy through + and - 2.5 MHz change in the IF center frequency. Dispersion accuracy must not exceed  $\pm 3\%$  over the center 8 divisions of the graticule sweep length.

- 26. Adjust Avalanche Voltage. Page 6-28

Connect the test oscilloscope to the 1 MHz MARKERS OUT, turn on the INT REF FREQ control. Adjust the Avalanche Volts R1131, from a counterclockwise position, clockwise until the avalanche transistor is just below the point of free running avalanche. Set the band selector to C. Push the LOCK CHECK button and tune the RF CENTER FREQUENCY control. Check for beat signals through band C.

- 27. Adjust 1 MHz Reference Frequency Range. Page 6-29

Apply the output from the 1 MHz MARKERS OUT connector, through a 20 dB attenuator, to J100 on the honeycomb assembly. Adjust L1108 for positive oscillator start as the INT REF FREQ control is turned from OFF to on position. Adjust L1104 for a frequency shift of 1.2 kHz in the 1 MHz oscillator, as the INT REF FREQ control is rotated through its range.

- 28. Adjust Band C Balance then Band A and B Balance. Page 6-30

Center the FINE RF CENTER FREQ control. Set the band selector to C. Push the LOCK CHECK button and adjust Band C Bal R1140, for a centered trace. Switch the band selector to B or A. Push the LOCK CHECK button and adjust band A and B Bal R1150 for a centered trace.

- 29. Check Dynamic Range of Vertical Display Modes. Page 6-31

Dynamic range of the 8 division screen is as follows: LIN  $\geq 26$  dB, LOG  $\geq 40$  dB and SQ LAW  $\geq 13$  dB.

- 30. Check Accuracy of IF ATTENUATOR selectors. Page 6-31

Apply a signal within the frequency range of one band, from a Signal Generator with a calibrated vari-

able attenuator output, to an RF INPUT connector of the Type 491. Check the accuracy of each IF ATTENUATOR dB selector against the calibrated attenuator on the Signal Generator. Accuracy must equal or exceed  $\pm 0.1$  dB/dB of attenuation.

- 31. Check Attenuation Range of IF Gain Control. Page 6-32

Check the range of the IF GAIN control. Must equal or exceed 50 dB.

- 32. Check INTENSIFIER Control Range. Page 6-32

Set the DISPERSION to 100 kHz/div, and the RESOLUTION control to maximum. Set the VERTICAL DISPLAY switch to LOG position and adjust the GAIN control for an 8 division display. Intensified portion of the display with the INTENSIFIER control fully clockwise should measure between 3.5 and 4.5 divisions.

- 33. Check Signal Amplitude to RECORDER Connector. Page 6-32

With VERTICAL DISPLAY in LIN position, the signal output to the RECORDER connector when terminated into 600  $\Omega$  load should equal or exceed 4 mV/ division of displayed signal.

- 34. Check Video Filter Operation. Page 6-32

- 35. Check Incidental Frequency Modulation. Page 6-32

Incidental FM for a 200 MHz IF signal should not exceed 200 Hz. Incidental FM for a tunable signal (IF + Local Oscillator) in phase lock condition should not exceed 300 Hz.

- 36. Adjust the Narrow Band IF Amplifier Peaking. Page 6-35

Apply a 200 MHz signal to J100 on the honeycomb assembly. Adjust T464, T454, C435 and C425, in the order listed, for optimum signal amplitude and symmetry. Adjust L444 for optimum amplitude and stable 70 MHz oscillator operation.

- 37. Adjust Wide Band Amplifier Response and Check System Flatness. Page 6-36

Apply a calibrated 75 MHz signal to J120. Connect a test oscilloscope to J188. Turn the 20 dB ATTENUATOR switch on.

Adjust L144 for maximum response to 75 MHz signal. Apply 65 MHz and adjust L147 for minimum response to 65 MHz. Remove the Signal Generator signal and test oscilloscope; reconnect honeycomb cables to J120 and J188.

Apply a frequency and amplitude calibrated signal to an RF INPUT connector and check the response flatness of the Type 491. Response flatness should vary over  $\pm 1.5$  dB over 50 MHz dispersion for band A,  $\pm 1.5$  dB over 100 MHz dispersion for bands B and C.

Adjust C137 and L134 for optimum sensitivity and response flatness. Adjust C68 on band B RF Mixer, for optimum sensitivity and bandpass flatness at the high frequency end (800 MHz) of band B.

Check system flatness as per Table 6-4, 6-5, and instructions to check band C. System flatness within  $\pm 1.5$

## CALIBRATION PROCEDURE

### General

In the following procedure, a test equipment setup is shown for each major setup change. Complete control settings are listed following the illustration. To aid in locating individual controls which have been changed during the complete calibration, the control names are printed in bold type. If only a partial calibration is performed, start with the setup preceding the desired portion of the procedure.

#### NOTE

When performing a complete recalibration, best performance will be obtained if each adjustment is

set to the exact setting, even if the Check is within the allowable tolerance. The following procedure uses the equipment listed under Equipment Required.

### Preliminary Procedure

Remove the instrument from the container, connect the autotransformer (if used) to a suitable power source, then connect the Type 491 power cord to the autotransformer output (or directly to the power source). Set the autotransformer output voltage to 115 (230) volts, check the rear panel power selector and set to the same nominal voltage. Turn the Type 491 power switch to on and allow at least 20 minutes warmup at 25° C, ±5° C before checking the instrument to the given accuracy.

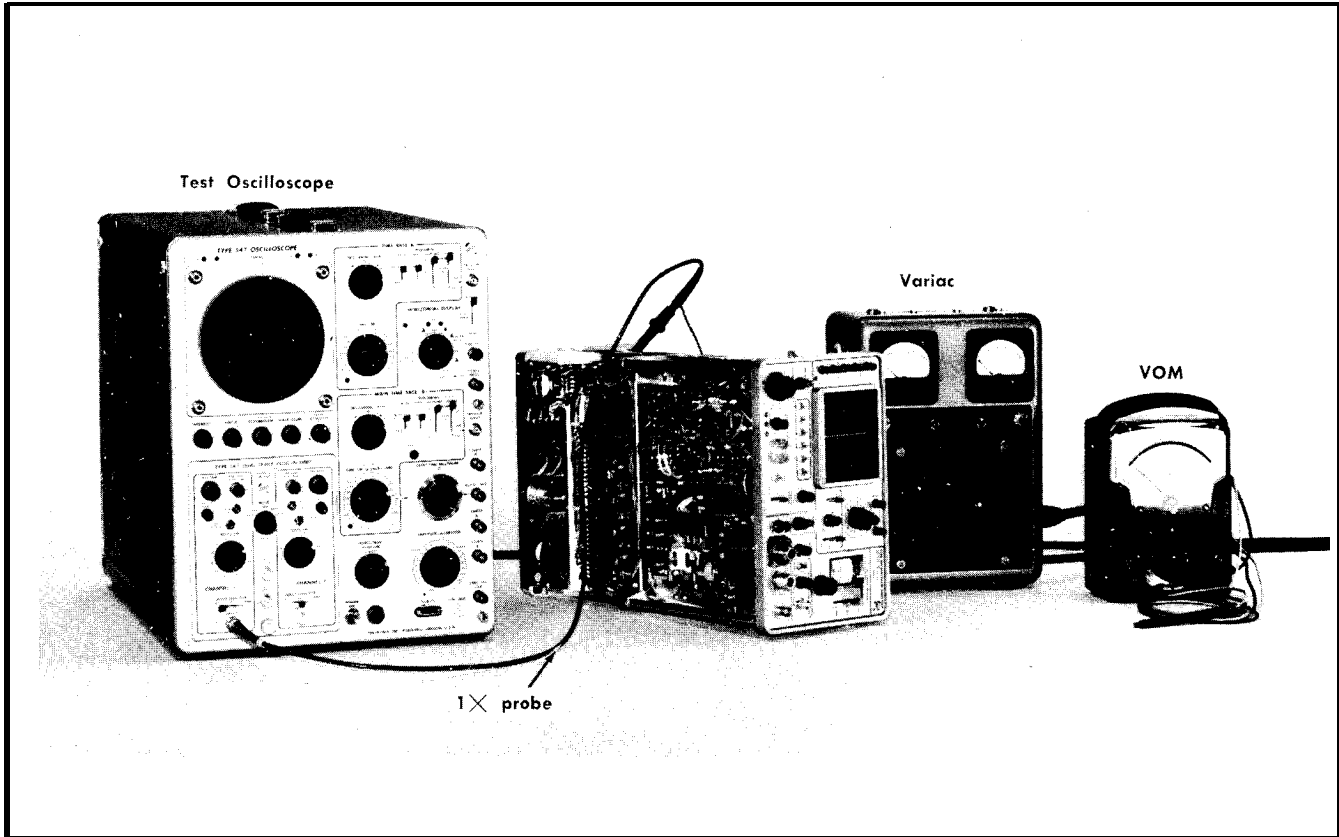

Fig. 6-4. Equipment setup for adjusting and checking the low and high voltage power supplies. Steps 1 through 6.

**Type 491**

**CRT Controls**

INTENSITY	CCW
FOCUS	Midrange
SCALE ILLUM	CCW
ASTIGMATISM	Midrange
INTENSIFIER	CCW-OFF
CONTRAST	Midrange
POSITION [Horizontal and Vertical]	Midrange

**TIME/DIV Controls**

TIME/DIV	2 mS
VARIABLE	CAL

**TRIGGER Controls**

SLOPE	+
LEVEL	FREE RUN
SOURCE	INT

**DISPERSION Controls**

DISPERSION RANGE	MHz/DIV
DISPERSION-COUPLED RESOLUTION	2 (Outside Ring)
IF ATTENUATOR dB	All switches in off position
IF CENTER FREQ Controls	Midrange (000)

VIDEO FILTER	OFF
VERTICAL DISPLAY	LIN
GAIN	Midrange
POWER	O N
MIXER PEAKING	SEARCH
FINE RF CENTER FREQ	Centered
PHASE LOCK Controls	
INT REF FREQ	O N
Band Selector	B
POWER SELECTOR	Proper voltage settings for power source used. See Operating Instructions.

**Test Oscilloscope**

Time/Cm	1 ms
Volts/Cm	.005
Input Coupling	AC

**1. Adjust - 10 volt supply**

**NOTE**

The - 10 volt supply affects the calibration of most circuits in the Type 491. If the voltage is within tolerance ( -9.9 to -10.1 volts), this adjustment should not be altered unless a complete recalibration is to be performed.



a. Equipment setup is shown in Fig. 6-4.

b. Turn the POWER switch to ON position, then connect a calibrated voltmeter between pin K on the Vertical Amplifier and Blanking circuit board, and chassis ground (see Fig. 6-5).

c. If the voltage is not within tolerance, adjust the -10 Volts adjustment R968, for a meter reading of -10 volts.

## 2. Check +10 Volt and + 150 Volt Power Supplies

### NOTE

The high voltage supply must be operating before the + 150 volt supply will regulate. If the high voltage supply is not operating, a substitution may be made by connecting a 30 volt battery between the + 150 volt supply and the high voltage 175 V supply as follows:

Connect the + lead of the battery to pin AO on the power supply board. Connect the - lead of the battery to pin AI.

a. Equipment setup is given in step 1.

b. Connect the voltmeter between pin L of the Vertical Amplifier and Blanking circuit board and chassis ground (see Fig. 6-5). Check the +10 volt supply. Must read between +9.7 and +10.3 volts (10 V  $\pm$ 3%).

c. Connect the voltmeter between pin M, of the Vertical Amplifier and Blanking circuit board, and ground. Check the +150 volt supply. Must read between +145.5 and +154.4 volts (+150V  $\pm$ 3%).

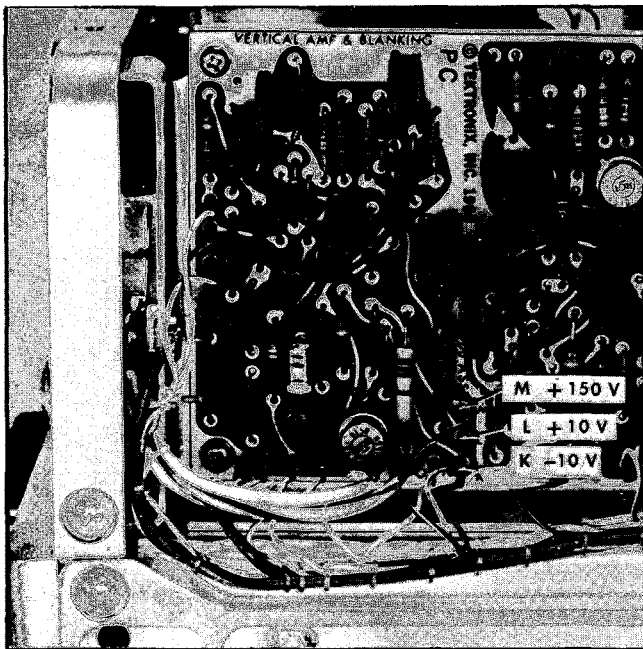

Fig. 6-5. Location of the low voltage check points.

## 3. Adjust High Voltage Power Supply 0

a. Test equipment setup is given in step 2.

b. Turn the POWER switch to OFF position. Remove the CRT base socket, then remove the plastic CRT base socket cover. Replace the base socket on the CRT.

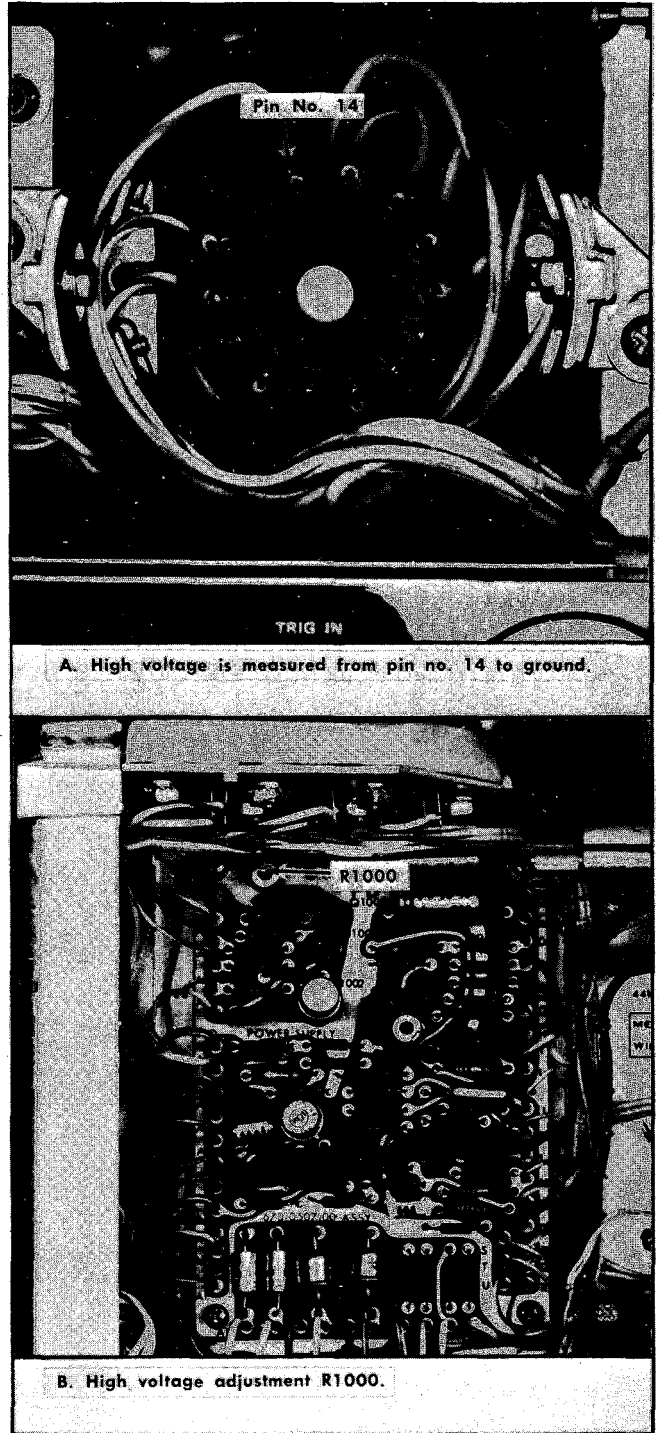

Fig. 6-6. Adjusting the - 3670 V supply.

c. Connect the voltmeter between pin 14 of the CRT base socket and chassis ground. (See Fig. 6-6). Set the voltmeter range to measure approximately 4000 volts.

d. Turn the POWER switch to ON and adjust the High Voltage Adj R1000 (Fig. 6-6) for a meter reading of -3670 volts.

e. Turn the POWER switch to OFF, remove the meter lead probes and replace the plastic protective cover over the

CRT base. (Align the two holes in the cover to the holes in the socket).

#### 4. Adjust Intensity Range

①

a. Test equipment setup is given in step 3.

b. Turn the POWER switch to the OFF position, then remove the high voltage fuse F1008.

c. Connect an ammeter across the fuse holder (Fig. 6-7). Set the ammeter range to 1A.

d. Turn the vertical POSITION control fully counterclockwise to position the beam off the CRT screen, turn the POWER switch to ON and the INTENSITY control fully clockwise.

#### NOTE

Be careful not to exceed 800 mA meter reading. If the Intensity Range is misadjusted, the current may exceed 800 mA and blow the high voltage fuse.

e. Adjust the Intensity Range R1032 for a current reading of 750 mA.

f. Turn the POWER switch to OFF, remove the meter leads and replace the high voltage fuse. Check that the fuse is a 1A fast blow. Turn the POWER switch to ON, then readjust the INTENSITY and POSITION controls for a centered trace of nominal brightness.

#### 5. Check Power Supply Voltage Regulation and Ripple Amplitude

a. Test equipment setup is given in step 4.

b. Connect the VOM to the voltage check points (Fig. 6-5), and check the voltage regulation of each regulated supply as the input line voltage is varied through the input line voltage range as shown in Table 6-1.

Connect the 1x probe from the test oscilloscope to the voltage check points and note the ripple amplitude. Voltage regulation and typical ripple amplitudes are listed in Table 6-2.

The input line voltage to the Type 491 is adjusted by means of the autotransformer which is connected between the source and the Type 491 input power connector.

TABLE 6-1

Line Voltage Selector	Input Voltage Range
LOW	90-110 VAC
MED	104-126 VAC
HIGH	112-136 VAC

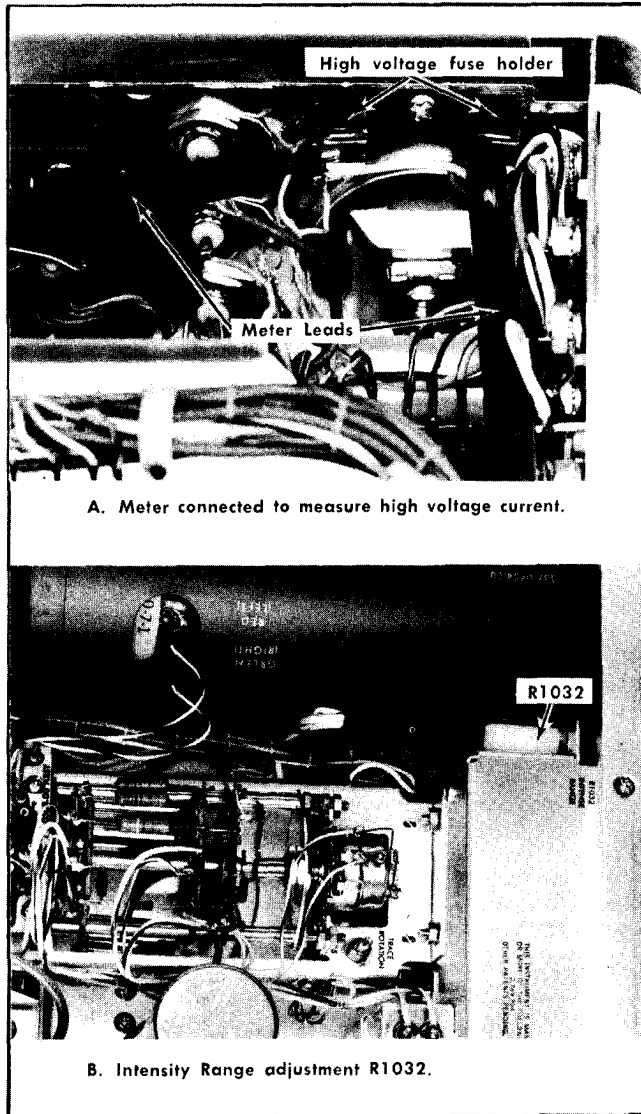

Fig. 6-7. Setting the high voltage current.

### CAUTION

When changing the input power selector range, the power should be removed by either turning the autotransformer power switch to off, or by disconnecting the input power cord to the Type 491.

TABLE 6-2

Supply	Voltage Regulation	Typical Ripple Amplitude
- 10 V	-9.9 to -1 0.1 V	$\leq 1$ m V
+ 10 V	9.7 to 10.3 V	$\leq 2$ m V
+150 V	145.5 to 154.5 V	$\leq 5$ m V

c. The following calibration steps do not require a line voltage control unit. Return the Line Voltage Selector to the operating range for the existing power source voltage. The Type 491 may be connected directly to the power source for the remainder of the calibration.

## 6. Adjust Trace Alignment



- a. Test equipment setup is given in step 5.
- b. Position a free running trace to the graticule center horizontal line.

c. Adjust the Trace Alignment R1035 (see Fig. 6-8) so the trace is aligned with the horizontal graticule centerline.

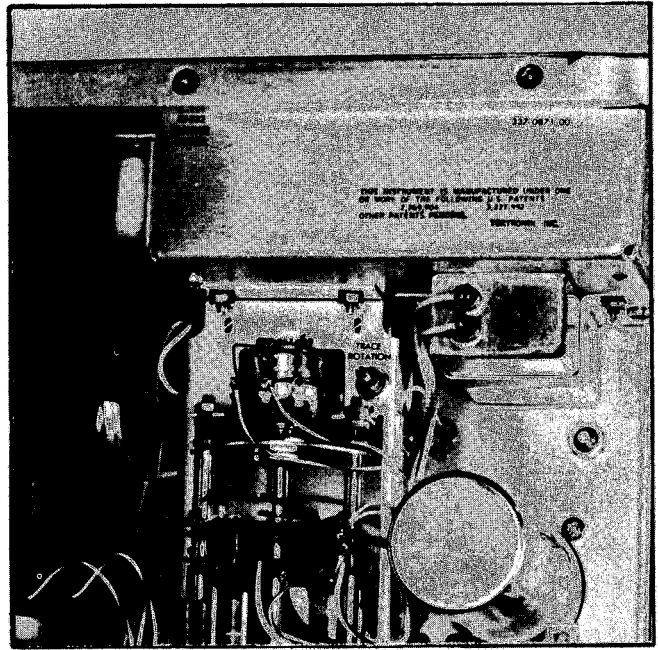

Fig. 6-8. Location of Trace Rotation R1035.

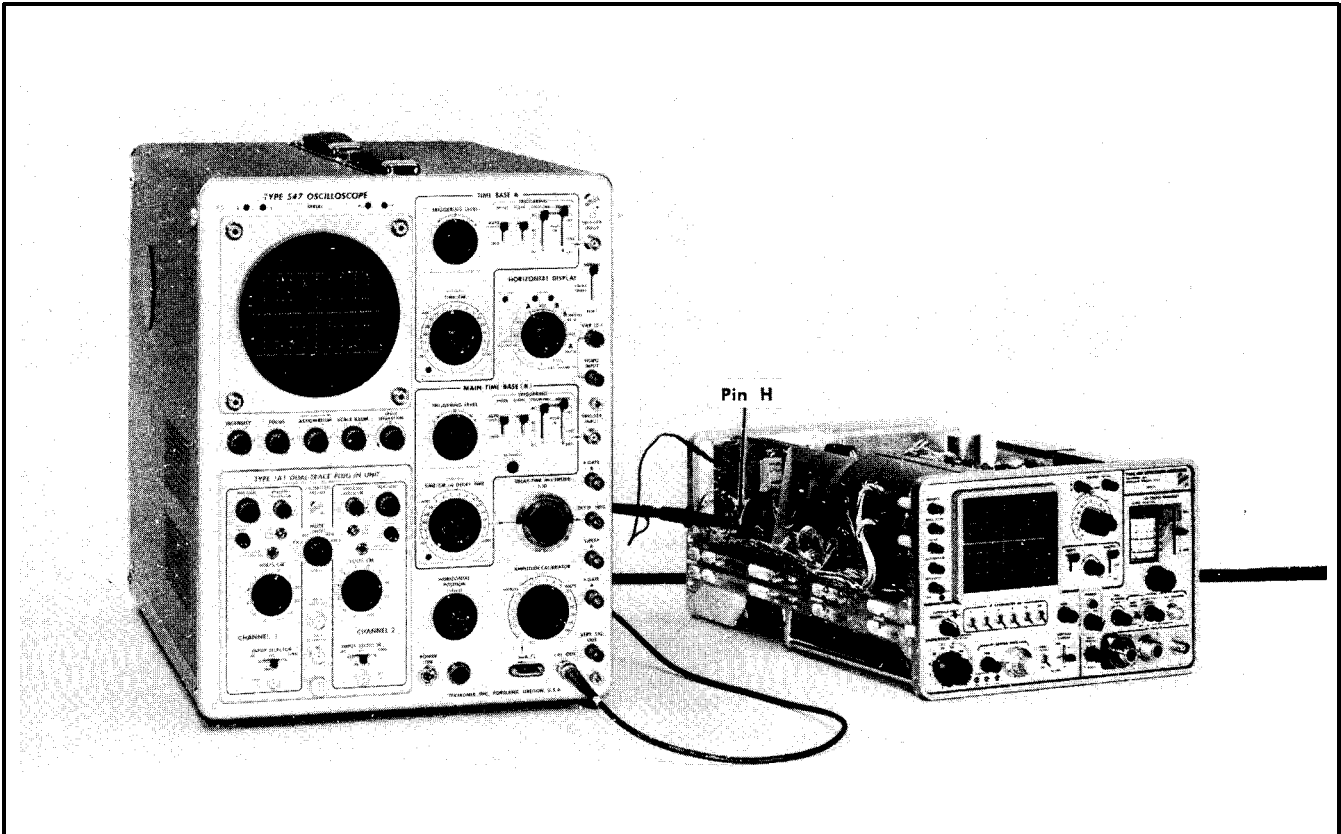

Fig. 6-9. Test equipment setup for adjusting Vertical Amplifier Gain.

**Type 491**

- INTENSITY Display of nominal brightness
- FOCUS and ASTIGMATISM Adjusted for optimum display definition
- SCALE ILLUM As desired
- POSITION (Horizontal and Vertical) Adjusted for a horizontally centered sweep on the graticule baseline
- TIME/DIV 2 mS
- VARIABLE TRIGGER CAL
- SLOPE +
- LEVEL FREE RUN
- SOURCE INT
- DISPERSION RANGE MHz/DIV
- DISPERSION-COUPLED RESOLUTION 5 MHz/div
- IF ATTENUATOR dB All switches in off position
- IF CENTER FREQ Controls Midrange (000)
- VIDEO FILTER OFF
- VERTICAL DISPLAY LIN
- GAIN CCW
- POWER ON

- MIXER PEAKING
- FINE RF CENTER FREQ
- PHASE LOCK Controls
- INT REF FREQ
- SEARCH Centered
- OFF or EXT REF FREQ IN

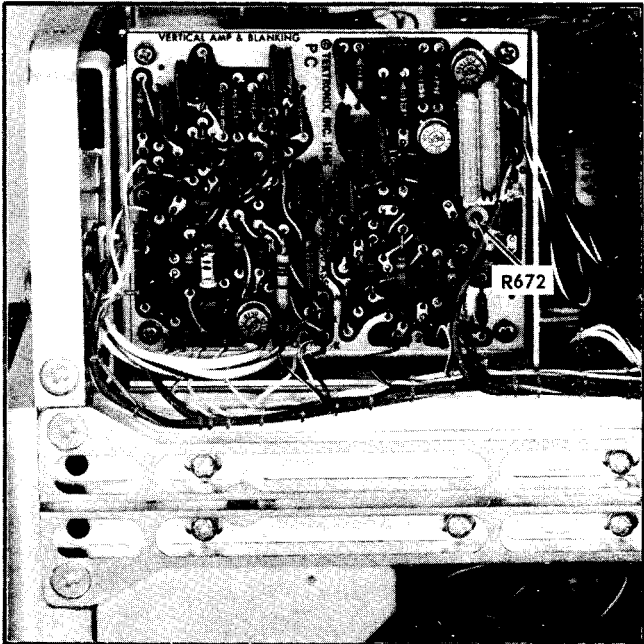

Fig. 6-10. Location of Vertical Amplifier Gain adjustment R672.

### Test Oscilloscope

Time/Cm	1 mS
Volts/Cm	.2
Input Coupling	DC
Trigger	Adjusted for free running sweep

#### 7. Adjust Vertical Amplifier Gain



- Test equipment setup is shown in Fig. 6-9.
- Set the Amplitude Calibrator of the test oscilloscope for a signal output of 0.5 volts.

c. Apply the output from Amplitude Calibrator through a 1x test probe to pin H of the Vertical Amplifier circuit board.

d. Adjust the Vertical Amplifier Gain R672 (Fig. 6-10) for a signal amplitude on the Type 491 of 5 major divisions.

#### 8. Check Range of Vertical Position Control

- Test equipment setup is given in step 7.
- With a 0.5 volt signal applied to pin H of the Vertical Amplifier board, adjust the Vertical POSITION control through its range.
- Check-The display should move out of the graticule area in each extreme position of the Vertical POSITION control.

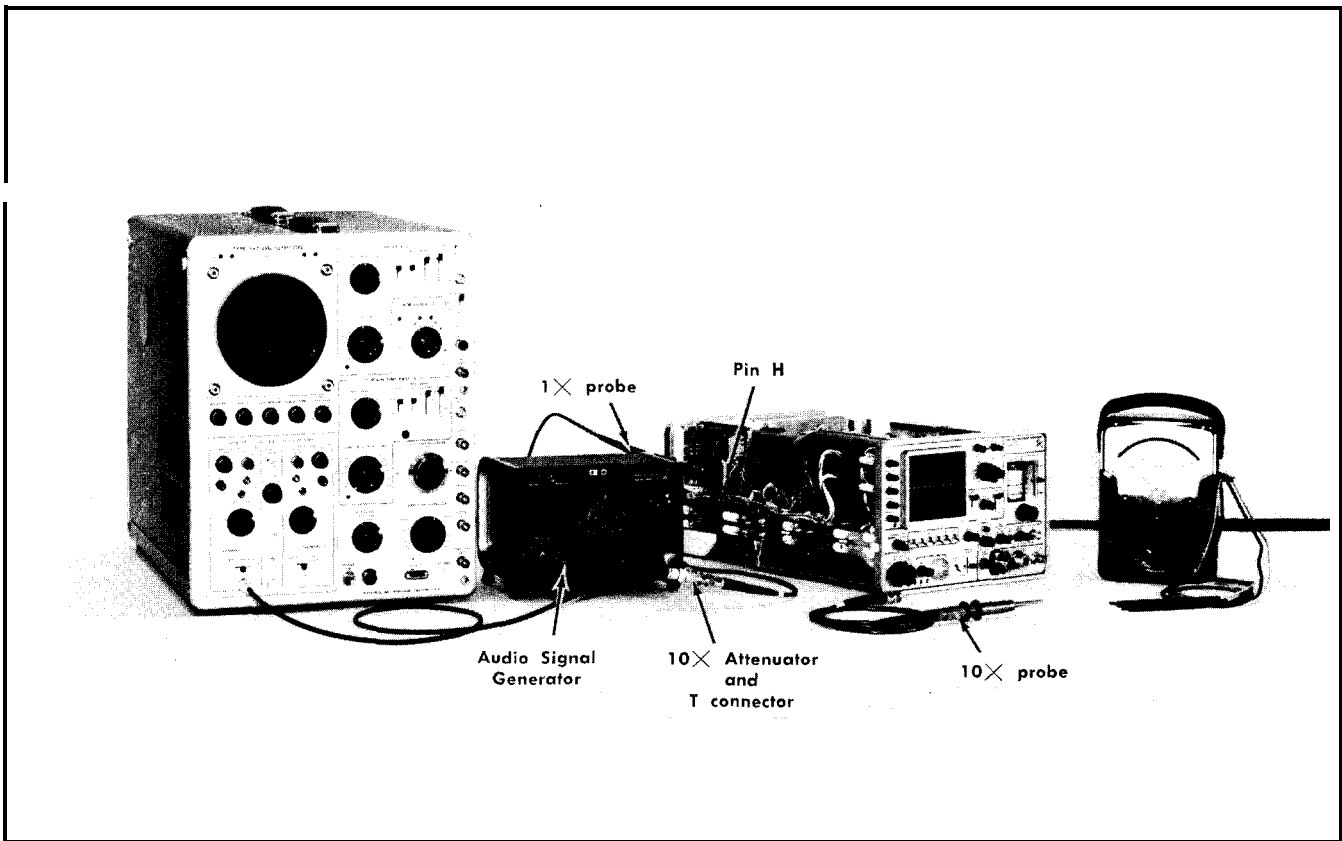

Fig. 6-11. Equipment setup for adjusting and checking triggering,

**Type 491**

INTENSITY	Display of nominal brightness
FOCUS and ASTIGMATISM	Adjusted for optimum display definition
INTENSIFIER	OFF
SCALE ILLUM	As desired
POSITION (Horizontal and Vertical)	Adjusted for a horizontally centered sweep on the graticule baseline
TIME/DIV	2 ms
VARIABLE	CAL
TRIGGER	
SLOPE	+
LEVEL	FREE RUN
SOURCE	INT
DISPERSION RANGE	MHz/DIV
DISPERSION-COUPLED RESOLUTION	5 MHz/DIV
IF ATTENUATOR dB	All switches in off position
IF CENTER FREQ	Midrange (000)
VIDEO FILTER	OFF
VERTICAL DISPLAY GAIN	LIN Midrange

POWER	O N
MIXER PEAKING	SEARCH
FINE RF CENTER FREQ	Centered
<b>PHASE LOCK Controls</b>	
INT REF FREQ	O N

**Test Oscilloscope**

Time/Cm	1 ms
Volts/Cm	.2
Input Coupling	DC
Trigger	Adjust for free running sweep

**9. Adjust Trigger Level Centering**



- a. Equipment setup is shown in Fig. 6-11.
- b. Apply the output signal of the Audio Signal Generator to pin H of the Vertical Amplifier circuit board. Set the Audio Signal Generator frequency to 20 kHz.
- c. Adjust the Trigger LEVEL control for a voltmeter reading of 0 volts between pin C (see Fig. 6-12) of the Horizontal Display board and chassis ground.
- d. Adjust the output of the Audio Generator for 0.2 division (1 minor division) display amplitude on the Type 491.
- e. Adjust the Trig Lev Center R724, for stable sweep triggering on both + and - SLOPE switch positions.

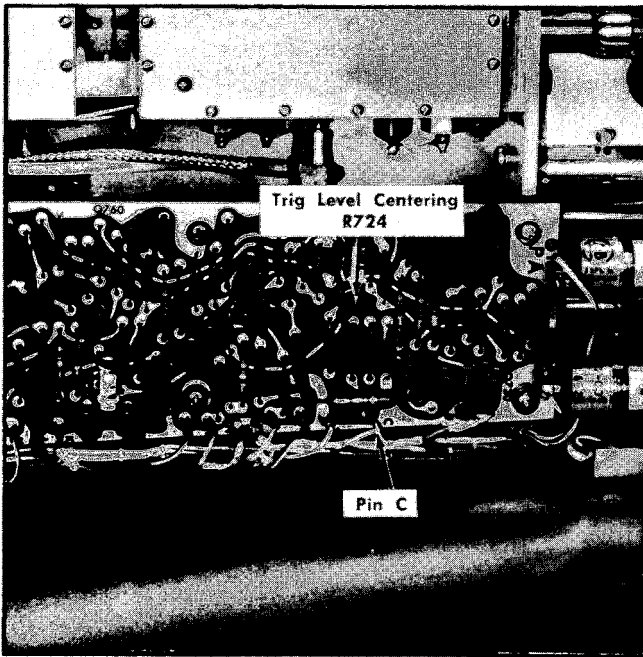

Fig. 6-12. Adjustments for trigger circuit on the horizontal display circuit board assembly.

## 10. Check External Triggering

- a. Equipment setup is given in step 9.
- b. Remove the audio signal connection from pin H of the Vertical Amplifier circuit board and apply the signal to both the TRIG IN connector on the rear panel of the Type 491 and to a test oscilloscope so the signal amplitude may be monitored.
- c. Set the Audio Signal Generator frequency to 20 Hz and adjust the output for 0.2 volts. (Monitor the output amplitude with the test oscilloscope.)
- d. Change the Type 491 Triggering SOURCE switch to EXT position and the TIME/DIV switch to .1 s position.
- e. Check external triggering. Must trigger with a 20 Hz, 0.2 volt signal applied, with the SLOPE switch in either the + or - positions.
- f. Increase the Audio Signal Generator frequency to 100 kHz. Readjust the output amplitude to 0.2 volts peak to peak.
- g. Check triggering-Must trigger with a 100 kHz, 0.2 V signal in the + and - SLOPE positions.
- h. Remove the audio signal from the TRIG IN connector.

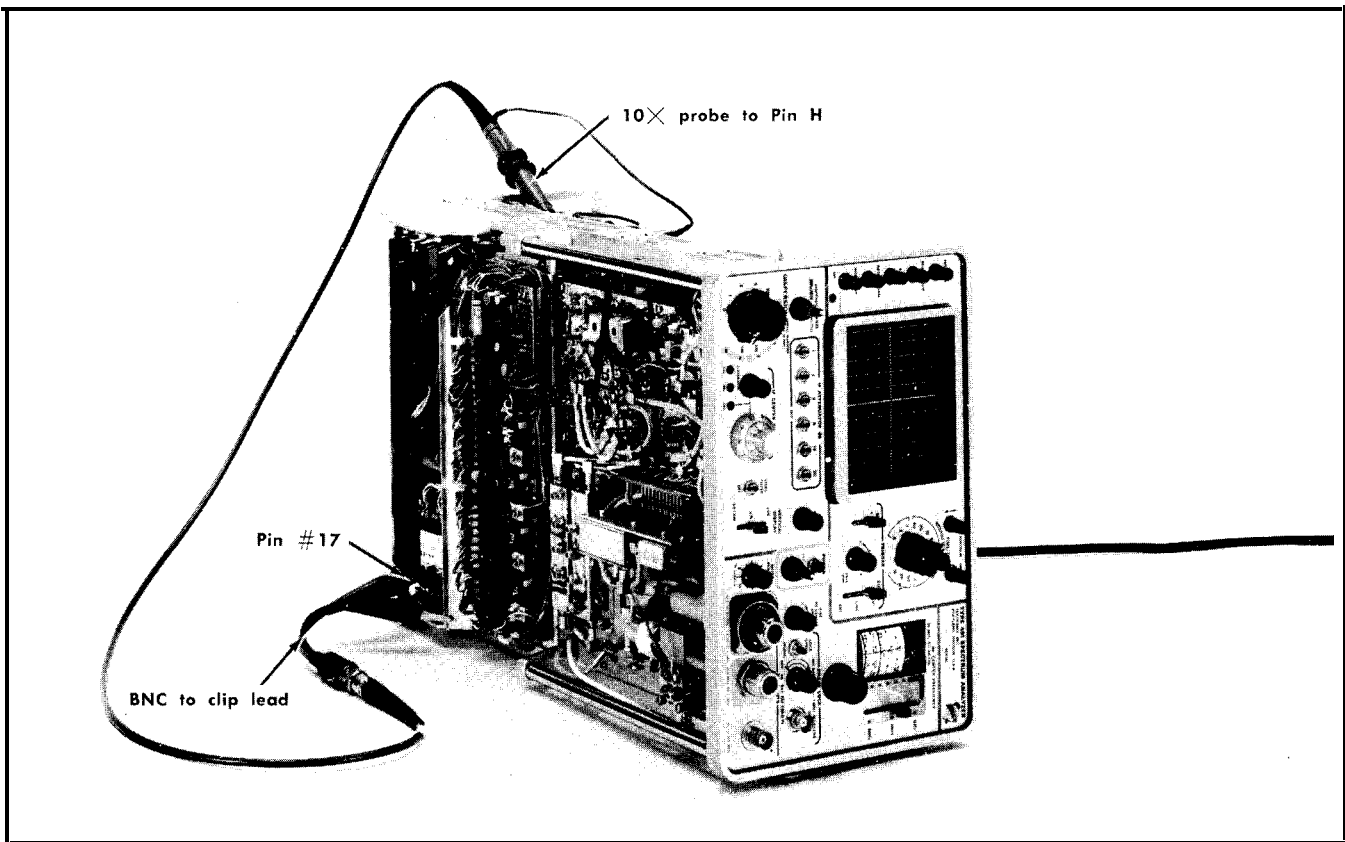

Fig. 6-13. Setup to check LINE triggering operation.

## 11. Check line Triggering

- a. Equipment setup is shown in Fig. 6-13.
- b. Switch the Triggering SOURCE selector to LINE position.
- c. Turn the POWER switch OFF, then connect a 10x test probe and a BNC to clip lead adapter between pin H of the Vertical Amplifier circuit board and pin 17 of the power transformer. See Fig. 6-13.

### CAUTION

- Use special care to avoid shorting the transformer terminal to ground or other transformer terminal.
- d. Set the TIME/DIV selector to 10 ms and turn the POWER switch to the ON position.
  - e. Check line triggering with the SLOPE switch in both the + and - positions. Display must trigger on the correct slope.
  - f. Remove the 10x probe and clip lead adapter. Return the TIME/DIV switch to 2 ms position and the Triggering SOURCE switch to INT position.



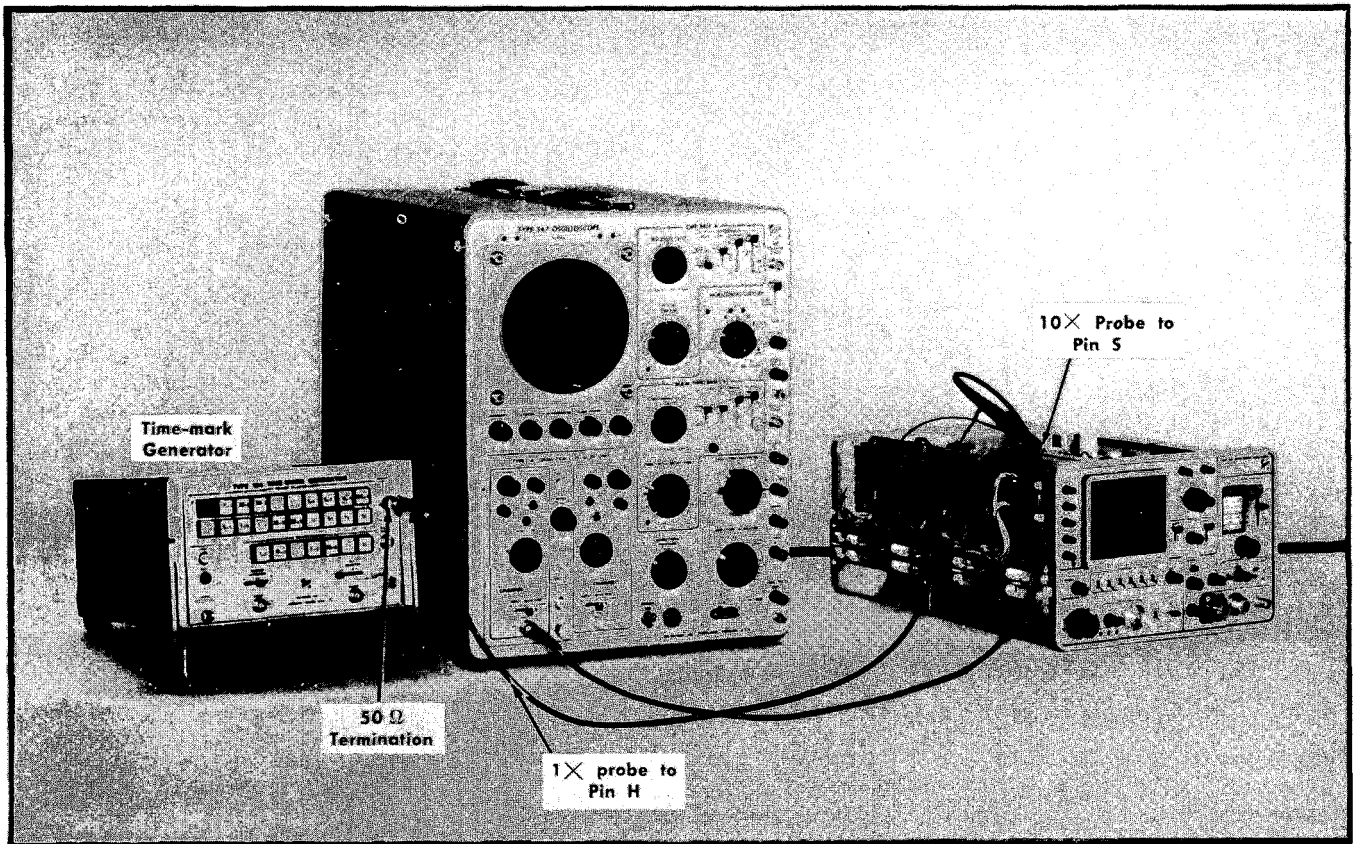

Fig. 6-14. Equipment setup to check and adjust sweep circuits, Steps 12 through 20.

### Type 491

INTENSITY	Display of nominal brightness
FOCUS and ASTIGMATISM	Adjusted for optimum display definition
INTENSIFIER	OFF
SCALE ILLUM	As desired
POSITION (Horizontal and Vertical)	Adjusted for a horizontally centered sweep on the graticule baseline
TIME/DIV VARIABLE	2 ms
TRIGGER	CAL
SLOPE	+
<b>LEVEL</b>	<b>FREE RUN</b>
SOURCE	INT
DISPERSION RANGE	MHz/DIV
DISPERSION-COUPLED RESOLUTION	5 MHz/div
<b>DISPERSION BAL</b>	<b>Centered</b>
IF ATTENUATOR dB	All switches in off position
IF CENTER FREQ	Midrange (000)
VIDEO FILTER	OFF
VERTICAL DISPLAY GAIN	LIN
POWER	Midrange
	ON

MIXER PEAKING	SEARCH
FINE RF CENTER FREQ	Centered
<b>PHASE LOCK Controls</b>	
INT REF FREQ	<b>OFF</b>

### Test Oscilloscope

Time/Cm	1 ms
<b>Volts/Cm</b>	<b>2</b>
Input Coupling	DC
<b>Trigger</b>	<b>Int.-Triggered display</b>

## 12. Adjust Sweep Length ①

- a. Equipment setup is given in Fig. 6-14,
- b. Connect the probe from the test oscilloscope to pin 5 of the Horizontal Amplifier circuit board.
- c. Adjust the Sweep Length R759 (see Fig. 6-15) for a 7.5 V peak to peak sawtooth waveform on the test oscilloscope

## 13. Adjust Sweep Calibration and Sweep Gain ①

- a. Equipment setup is given in step 12.
- b. Apply 0.1 ms markers from the Time-Marker Generator to pin H of the Vertical Amplifier circuit board. Set the Type 491 TIME/DIV selector to .1 ms. Adjust the LEVEL control for a triggered display.

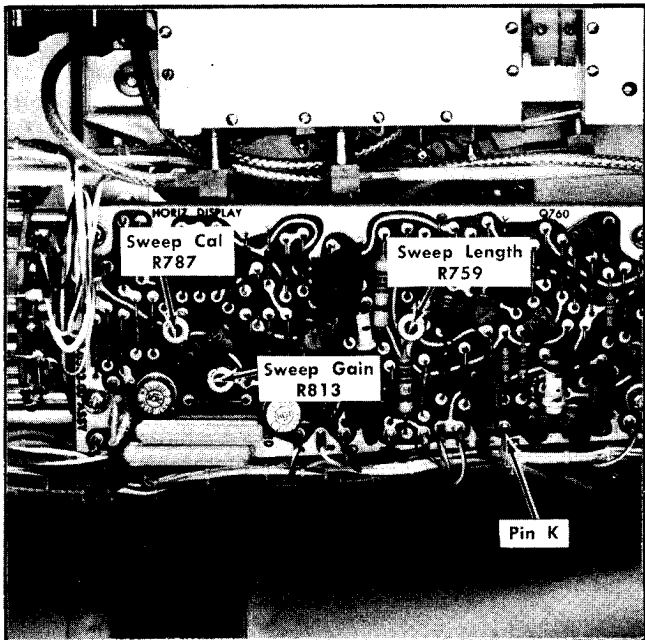

Fig. 6-15. Location of trigger and sweep adjustments.

c. Preset the Sweep Cal R787 to midrange. Adjust the Sweep Gain R813 (see Fig. 6-15) for 10.5 divisions of sweep length. Adjust Sweep Cal R787 for 1 marker per division. Sweep timing must be within  $\pm 3\%$  (1.2 minor divisions) over the center 8 graticule divisions.

TABLE 6-3

TIME/DIV	Time Marker Selector	Display (markers/div)
1 ms	1 ms	1
2 ms	1 ms	2
5 ms	5 ms	1
10 ms	10 ms	1
20 ms	10 ms	2
50 ms	50 ms	1
.1 s	.1 s	1
.2 s	.1 s	2
.5 s	.5 s	1
.5 ms	.5 ms	1
.2 ms	.1 ms	2
.1 ms	.1 ms	1
50 $\mu$ s	50 $\mu$ s	1
20 $\mu$ s	10 $\mu$ s	2
10 $\mu$ s	10 $\mu$ s	1

#### 14. Check Sweep Timing Accuracy

- Equipment setup is given in step 13.
- With the Marker Output signal from the Time-Mark Generator applied to pin H of the Vertical Amplifier circuit board, adjust the LEVEL control for a stable triggered trace.

Position the zero timing mark and the start of the trace on the left graticule line.

- Check timing accuracy ( $\pm 3\%$ ) at each position of the TIME/DIV selector. Marker input and Type 491 display for each position is listed in Table 6-3.

#### 15. Check VARIABLE Control Range

- Equipment setup is given in step 14
- Apply 5 ms markers to pin H of the Vertical Amplifier circuit board assembly. Set the Type 491 TIME/DIV selector to 1 ms and adjust the Triggering LEVEL control for a stable display. (One 5 ms marker/5 divisions.)
- Turn the VARIABLE control fully counterclockwise.
- Check-A minimum of five markers should be displayed within the 10 division graticule width. Variable control range 2.5:1.

#### 16. Check SAW OUT Signal Amplitude

- Equipment setup is given in step 12.
- Connect the 1x probe from the test oscilloscope to the SAW OUT connector on the rear panel of the Type 491.

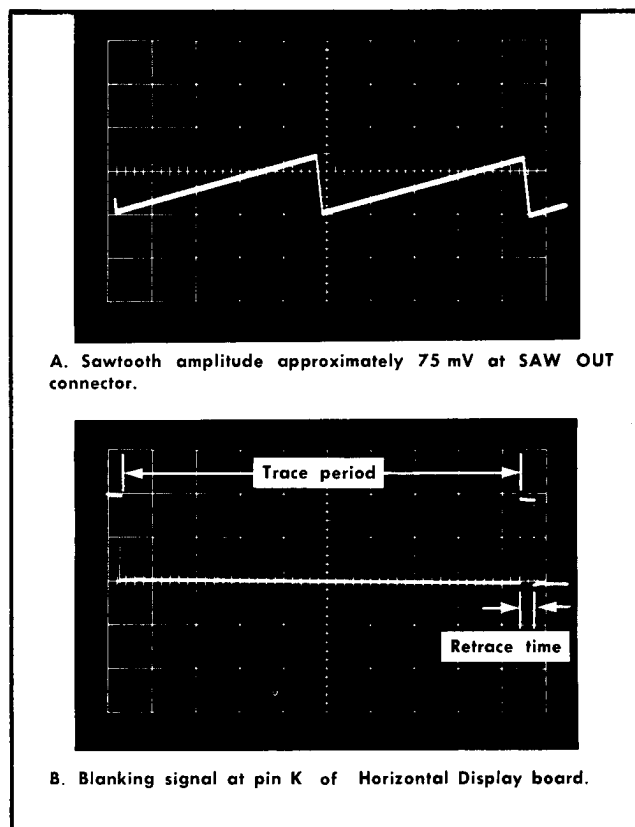

Fig. 6-16. Sawtooth waveform and blanking waveform.

c. Check—The amplitude of the SAW OUT signal, should measure between 70 and 90 mV.

## 17. Check Unblinking Waveform

- Equipment setup is given in step 16.
- Connect the 1x probe from the test oscilloscope to pin K of the Horizontal Display circuit board.
- Check unblinking waveform. Amplitude should measure between 8.0 V and 9.0 V, typically 9.0 V (see Fig. 6-16).
- Remove the 1x probe.

### Sweep Circuit

## 18. Adjust RF Amplitude ①

- Test equipment setup is given in Fig. 6-14.
- Set the TIME/DIV selector to 20 ms. Apply a calibrated 200 MHz signal from the Time-Mark Generator (2nd harmonic of 10 ns sine wave) through a 20 dB attenuator to band B RF INPUT connector. Switch the RF INPUT selector to band B. Set the TIME/DIV to 20 ms.
- Adjust the GAIN control for a displayed IF signal amplitude of 6 divisions. Tune the RF CENTER FREQUENCY control for minimum converted signal interference.
- Establish zero volt reference level on the test oscilloscope by connecting the probe to chassis ground on the Type 491, then connect the probe to pin P of the square pin connector for the honeycomb assembly. See Fig. 6-17.

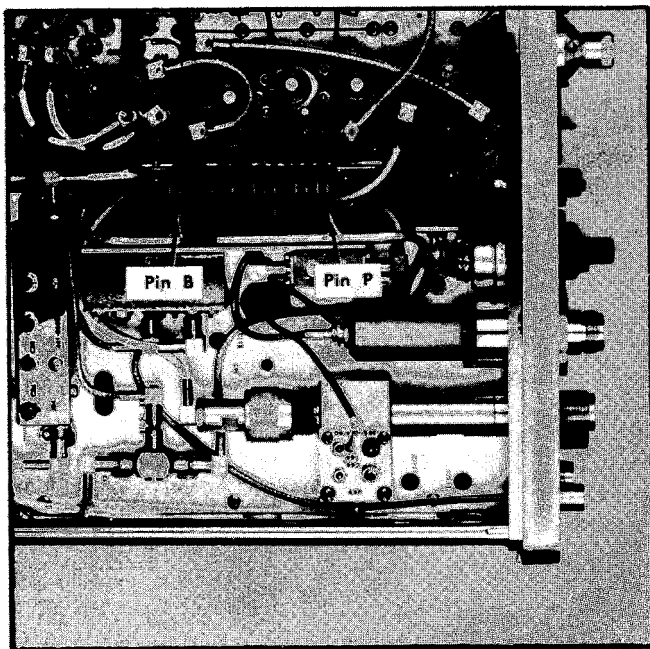

Fig. 6-17. Location of pin P on the honeycomb square pin connector.

e. Adjust the RF Ampl R290 (see Fig. 6-18) for  $-0.85$  volts  $\pm 0.1$  volt of trace deflection on the test oscilloscope.

f. Switch the VERTICAL DISPLAY switch to LOG position and check the display with 100 kHz dispersion. If the RF Ampl

voltage is too high it will produce a display similar to an amplitude modulated signal, with sidebands 100 kHz to 180 kHz from the IF feedthrough signal. If this type of display is present reduce the RF amplitude voltage to eliminate the side bands.

g. Return the DISPERSION RANGE and DISPERSION selectors to the 10 MHz/div positions. Switch the VERTICAL DISPLAY selector to LIN. Remove the probe from pin P of the honeycomb connector.

## 19. Adjust Center Frequency Range ①

- Test equipment setup is given in step 18.

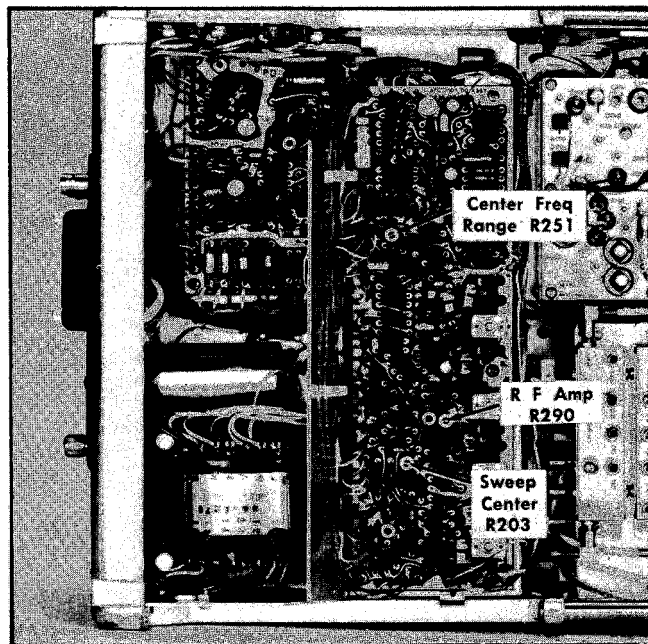

Fig. 6-18. Sweeper circuit adjustments.

### NOTE

The IF CENTER FREQ controls and the IF CENTER FREQ-CAL adjustment must be centered (000).

b. Adjust the Center Freq Range R251 (Fig. 6-18) for minimum IF signal shift as the DISPERSION selector is rotated through the 10 MHz to the .2 MHz positions. The DISPERSION RANGE switch must be in the MHz/DIV position for this adjustment.

c. Return the DISPERSION selector to the 10 MHz position.

## 20. Adjust Sweep Center ①

- Equipment setup is given in step 19.
- Adjust the Horizontal POSITION control to center the sweep. ( $\frac{1}{4}$  of a division sweep extension from either end of the graticule.)
- Adjust the Sweep Center R203 (Fig. 6-18) to position the 200 MHz signal at the graticule center horizontal line.

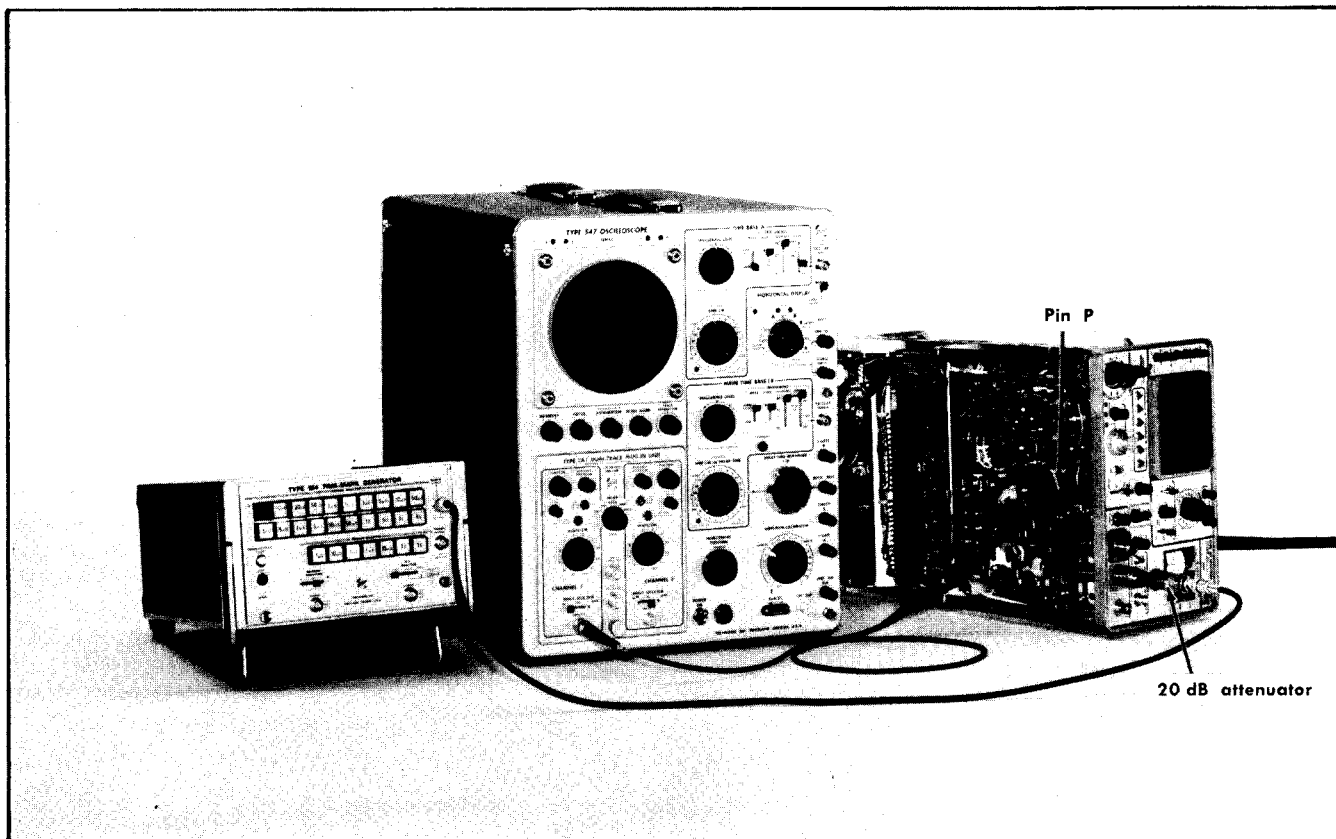

Fig. 6-19. Test equipment setup to adjust and check dispersion accuracy.

### Type 491

INTENSITY	Display of nominal brightness
FOCUS and ASTIGMATISM	Adjusted for optimum display definition
INTENSIFIER	OFF
SCALE ILLUM	As desired
POSITION (Horizontal and Vertical)	Adjusted for a horizontally centered sweep on the graticule baseline
TIME/DIV	20 ms
VARIABLE	CAL
TRIGGER	
SLOPE	+
LEVEL	Triggered sweep
SOURCE	LINE
DISPERSION RANGE	MHz/DIV
<b>DISPERSION-COUPLED RESOLUTION</b>	<b>10 MHz/div</b>
<b>DISPERSION CAL</b>	<b>Midrange</b>
<b>DISPERSION BAL</b>	<b>Midrange</b>
IF ATTENUATOR dB	All switches in off position
IF CENTER FREQ	Midrange (000)
VIDEO FILTER	OFF
VERTICAL DISPLAY	LIN
GAIN	Midrange
POWER	ON
MIXER PEAKING	SEARCH

FINE RF CENTER FREQ	Centered
PHASE LOCK Controls	
INT REF FREQ	OFF

### Test Oscilloscope

Time/Cm	1 ms
Volts/Cm	.5
Input Coupling	AC

## 21. Adjust MHz/DIV Dispersion and Linearity



### NOTE

Dispersion accuracy is a measure of the frequency dispersion error within 8 divisions of a 10 division display. It is measured by positioning the 1st frequency marker on the 1st graticule line, then noting the dispersion error as the distance the 9th marker is displaced from the 9th graticule line. See Fig. 6-20.

Linearity error is the measured distance any marker is displaced from its respective graticule line when compared over an 8 major division display. See Fig. 6-21.

Dispersion accuracy and the display linearity are affected by the RF output amplitude, circuit constants, etc. DISPERSION CAL adjustment R208 primarily affects the dispersion accuracy and C358 the linearity. If these two adjustments will not

calibrate the dispersion to specifications, the following techniques may be tried.

Shift the sweep oscillator RF output voltage to a new level. (The output voltage level must remain

within 0.75 to 1.0 volt). If the level is changed, the Center Freq Range adjustment and a check for sidebands must be repeated.

Interchange Q310, Q340 and Q350. The slight differences between the transistor parameters will have some effect on display linearity. Changing these transistors is only recommended if new transistors have been installed or components have been changed and linearity cannot be obtained by other means,

a. Equipment setup is given in Fig. 6-19.

b. Apply .1  $\mu$ s and 10 ns markers from the Time-Mark Generator (Type 184) through a 20 dB attenuator to band B RF INPUT connector, Set the VERTICAL DISPLAY switch to LOG position.

c. Adjust the Type 491 GAIN control for a display amplitude of approximately 6 divisions. See Fig. 6-20. Set the SOURCE switch to LINE and adjust the LEVEL control for a triggered display.

NOTE

More than one set of 1 MHz markers may appear on the display. To avoid confusion, tune the RF CENTER FREQUENCY and FINE FREQ controls to align the tunable markers with the fixed (IF feed-through markers).

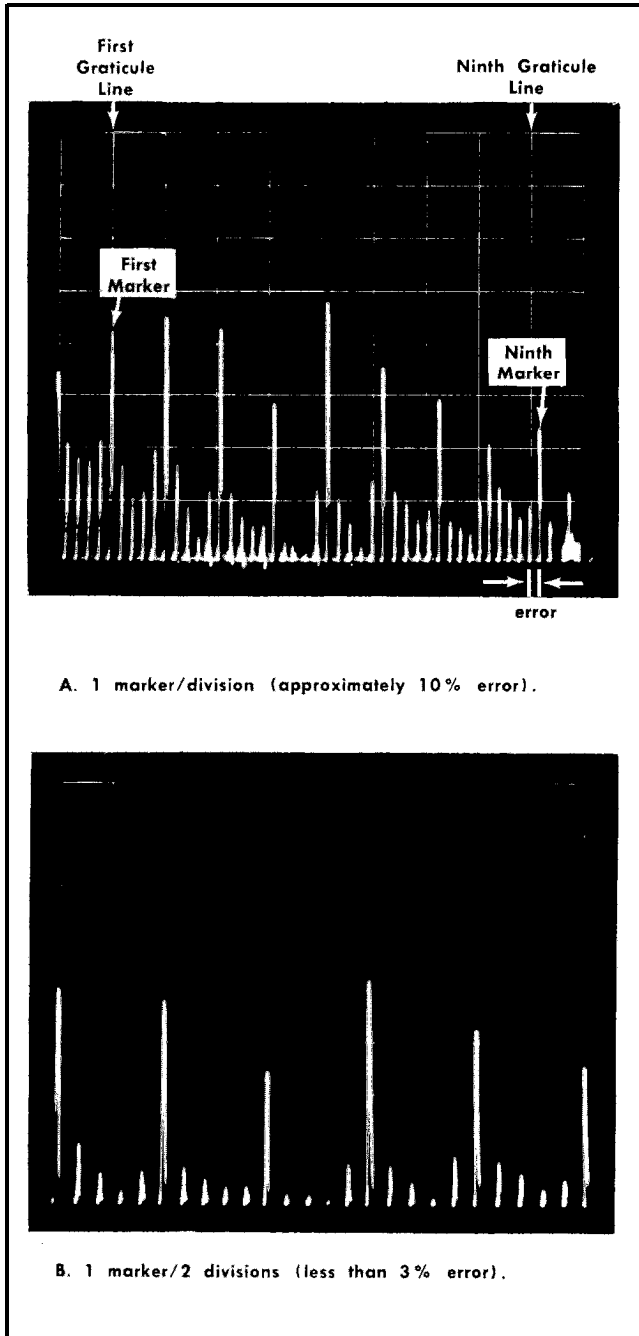

Fig. 6-20. Measuring dispersion accuracy.

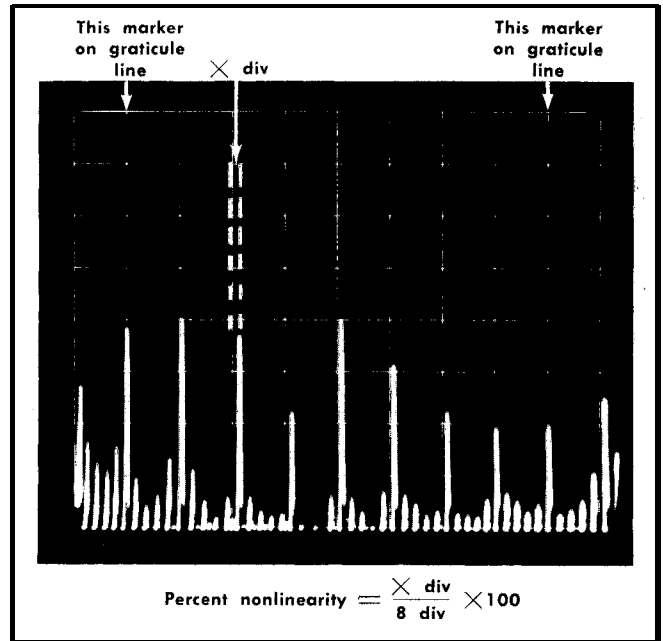

Fig. 6-21. Measuring dispersion linearity.

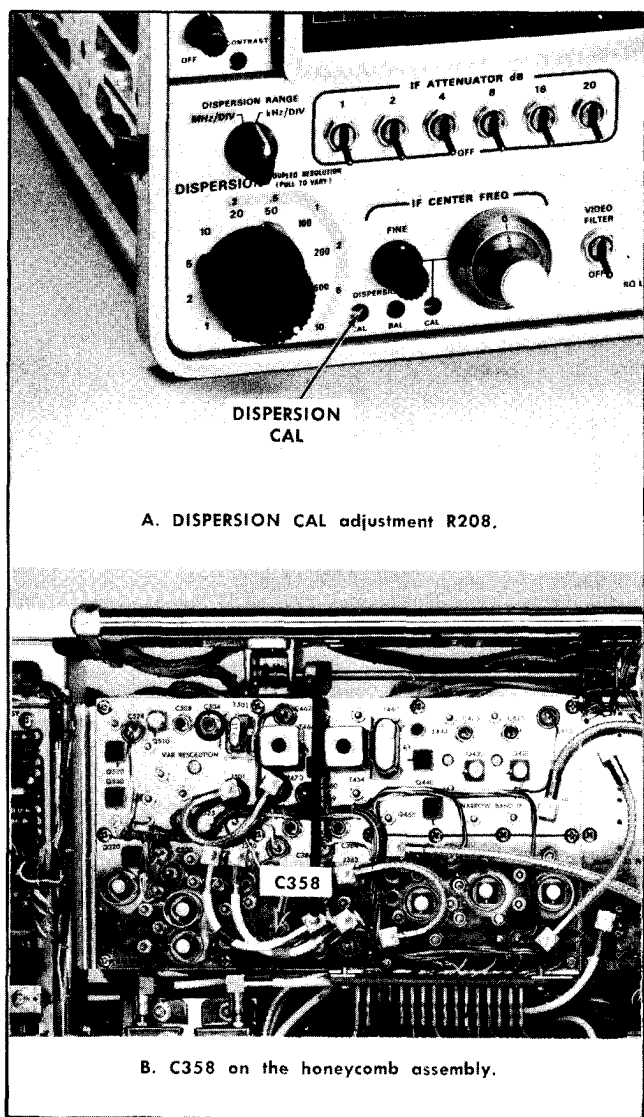

Fig. 6-22. Dispersion calibration adjustments.

d. Adjust the DISPERSION CAL R208 (Fig. 6-22) for 1 marker/division over the center 8 graticule divisions, then adjust C358 for display linearity.

e. Repeat the adjustment of R208 and C358 for optimum dispersion accuracy and display linearity. If the dispersion linearity is not within tolerance, a slight re-adjustment of the RF Ampl R290 and the Center Freq Range R251 adjustments may be required. Monitor the voltage at pin P of the honeycomb square pin connector with the test oscilloscope to keep the RF voltage amplitude within 0.75 to 1.0 volts and recheck step 18.

## 22. Check Dispersion Accuracy of MHz/DIV Ranges and Range of IF CENTER FREQ Control

- Test equipment setup is given in step 21.
- Center the IF CENTER FREQ controls.
- Check the dispersion accuracy for each MHz/DIV setting of the DISPERSION selector as listed in Table 6-4. The Horizontal POSITION central, or the IF CENTER FREQ control may be used to align the prime markers to the graticule divisions. As the DISPERSION is decreased, the RESOLUTION control should remain in the coupled position.
- Check the range of the IF CENTER FREQ control plus the dispersion accuracy and linearity over this range, in the 5, 2, 1, .5 and .2 MHz positions of the DISPERSION selector.

Range of the coarse control should equal or exceed + and - 25 MHz from its centered position. It is checked by rotating the control to both extreme positions from center and noting the frequency shift of the .1  $\mu$ s or 10 MHz markers as the control is rotated. Dispersion accuracy and display linearity must remain within the listed specifications of Table 6-4 to the + and - 25 MHz positions.

e. Center the coarse IF CENTER FREQ control. Set the DISPERSION control to 1 MHz position and apply 10 ns and 1  $\mu$ s markers from the Time-Mark Generator.

f. Check the range of the IF CENTER FREQ-FINE control. Must equal or exceed + and - 1 MHz from its centered position.

TABLE 6-4

DISPERSION Position	Marker Selector	Markers/Div	Allowable Error	Supplementary Notes
10 MHz	10 ns and .1 $\mu$ s	1	$\pm 3\%$	Change allowed with $\pm 10$ MHz change in center frequency, measured over the center 8 div.
5 MHz	10 ns and .1 $\mu$ s	1 marker/2 div	$\pm 3\%$	Over the $\pm 25$ MHz range of the IF CENTER FREQ control. Display linearity over a 10 division display must be within $\pm 3\%$ .
2 MHz	10 ns and .5 $\mu$ s	1	$\pm 5\%$	
1 MHz	10 ns and 1 $\mu$ s	1	$\pm 7\%$	
.5 MHz	10 ns and 1 $\mu$ s	1 marker/2 div	$\pm 10\%$	
.2 MHz	10 $\mu$ s and 5 $\mu$ s	1	$\pm 15\%$	

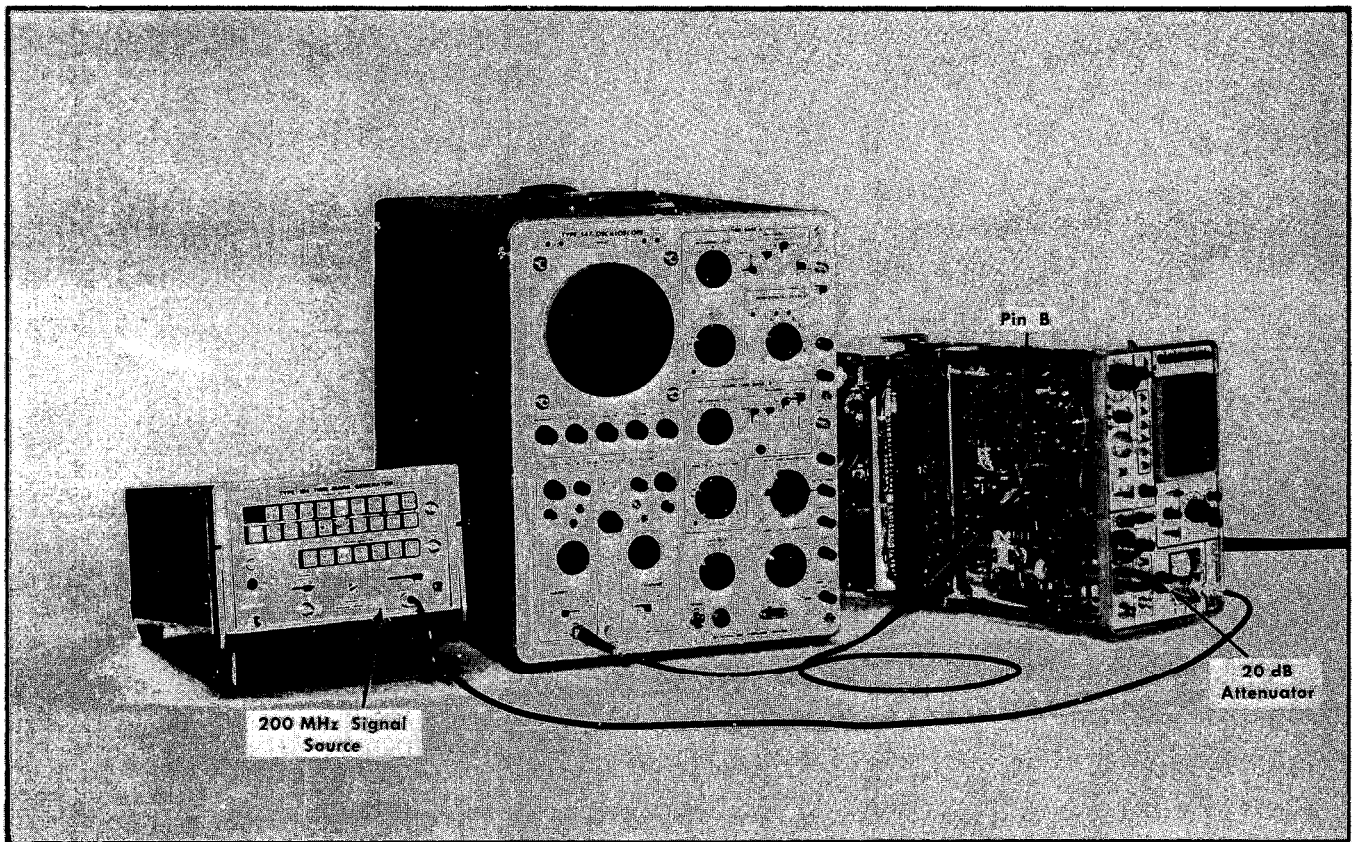

Fig. 6-23. Test equipment setup to adjust IF amplifier and the resolution bandwidth.

**Type 491**

INTENSITY	Display of nominal brightness
FOCUS and ASTIGMATISM	Adjusted for optimum display definition.
INTENSIFIER	OFF
SCALE ILLUM	As desired
POSITION (Horizontal and Vertical)	Adjusted for a horizontally centered sweep on the graticule baseline.
TIME/DIV	2 ms
VARIABLE	CAL
TRIGGER	
SLOPE	+
LEVEL	Triggered sweep
SOURCE	LINE
<b>DISPERSION RANGE</b>	<b>kHz/DIV</b>
<b>DISPERSION-COUPLED RESOLUTION</b>	<b>Set the DISPERSION to 50, uncouple the RESOLUTION control and turn fully clockwise.</b>
IF ATTENUATOR dB	All switches in off position
IF CENTER FREQ Controls	Midrange (000)
VIDEO FILTER	OFF
VERTICAL DISPLAY	LIN

GAIN	Midrange
POWER	ON
MIXER PEAKING	SEARCH
FINE RF CENTER FREQ	Centered
PHASE LOCK Controls	
INT REF FREQ	OFF
<b>Test Oscilloscope</b>	
Time/Cm	1 ms
Volts/Cm	.05
Input Coupling	AC
Trigger	LINE

**23. Adjust IF Amplifier Response and Resolution Bandwidth**

a. Equipment setup is shown in Fig. 6-23.

**NOTE**

Resolution bandwidth should be pre-adjusted before calibrating the kHz/div dispersion. Repeat this step after adjusting kHz/div dispersion if kHz/div dispersion error is greater than 6%.

b. Apply 200 MHz signal (2nd harmonic of 10 ns) from the Time-Mork Generator (Type 184) through a 20 dB attenuator and proper adapter to the RF INPUT connector.

Two alternate methods of 200 MHz signal application are as follows:

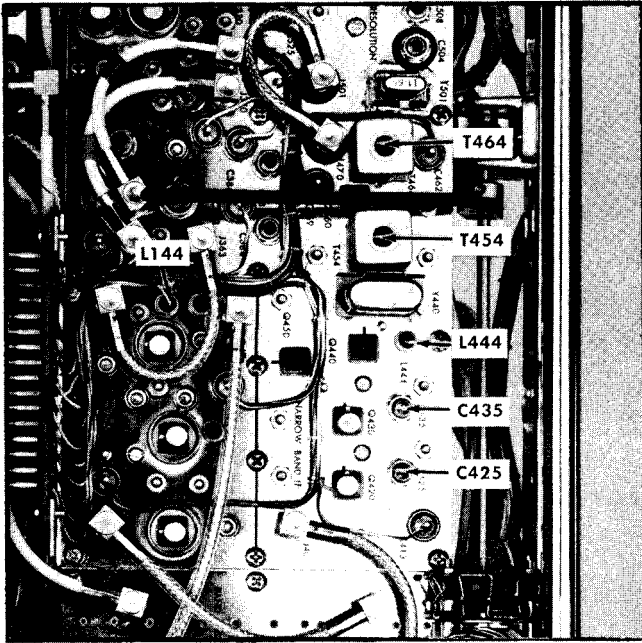

Fig. 6-24. Location of narrow band IF amplifier adjustments.

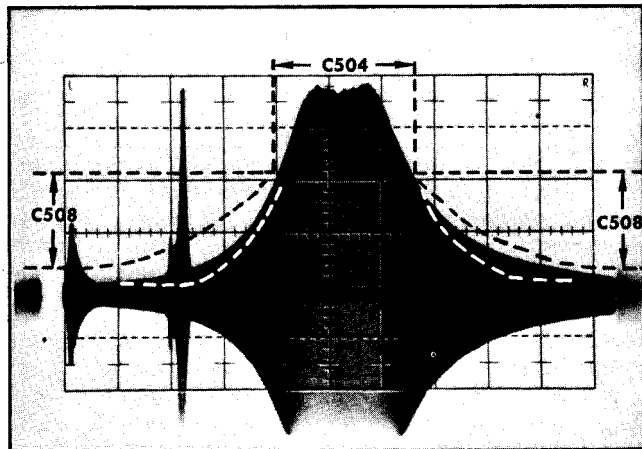

Fig. 6-25. Typical test oscilloscope display when C504 and C508 are adjusted correctly. Dispersion 50 kHz/div, RESOLUTION selector fully clockwise.

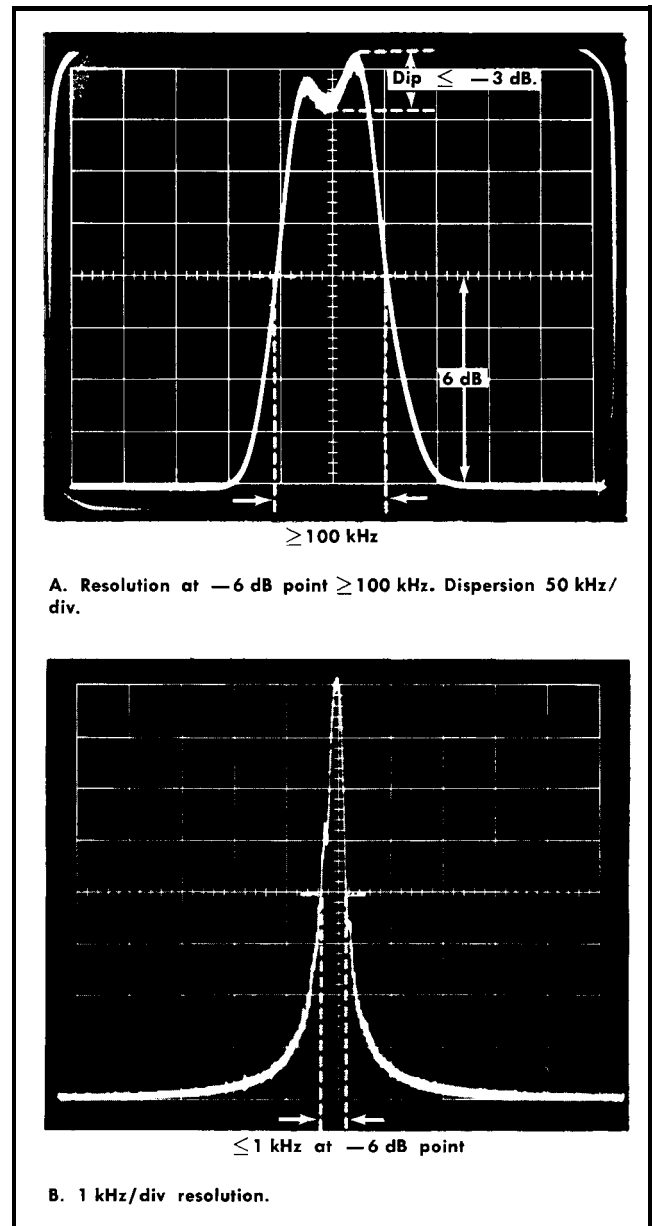

Fig. 6-26. Display pattern when resolution is correctly adjusted.

1. Install the Waveguide Mixer Adapter into band C, RF INPUT receptacle. Apply the 200 MHz signal from the Time-Mark Generator through a 20 dB attenuator and adapter to the Waveguide Mixer adapter. Switch the band selector to c.

2. Apply 200 MHz signal below - 50 dBm from an accurate signal generator through a 50  $\Omega$  termination or attenuator and a P6041 or P6040 probe cable adapter to subminiature connector J100 on the wide band-pass filter of the honeycomb assembly.

c. Turn the GAIN central fully clockwise and switch in the required IF ATTENTION to reduce the signal amplitude to approximately 4 divisions.



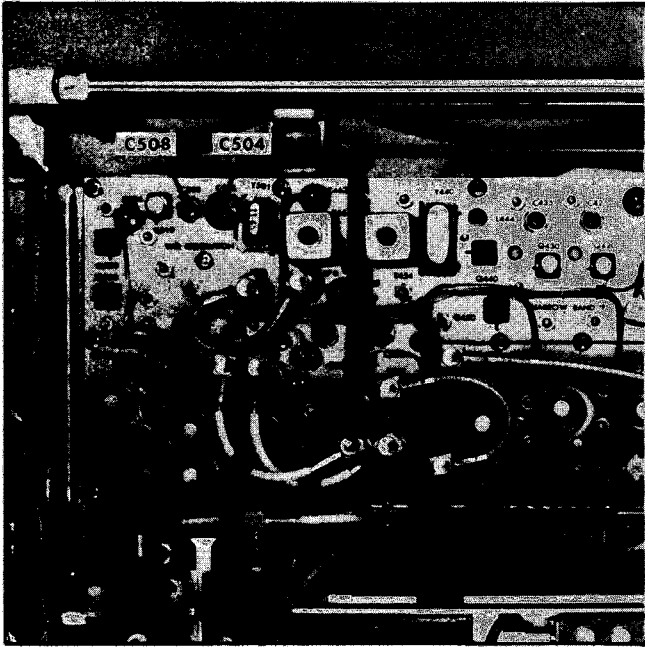

Fig. 6-27. Location of C504 and C508.

d. Adjust L444 (wide band amplifier), T464, T454, C435 and C425 (Fig. 6-24) in the order listed for optimum signal amplitude.

e. Adjust L444 for stable 60 MHz oscillator operation. The stable point is midway between the oscillator dropout points when the core of L444 is turned in and out through the operating range. (Remove the P6041 or P6040 cable if connected and reconnect the cable to J100.)

f. With 200 MHz signal applied to the RF INPUT as described in step b, set the DISPERSION to 50 kHz/div, the RESOLUTION fully clockwise, IF ATTENUATOR for 20 dB, and adjust the GAIN control for a signal amplitude of 8 divisions. Center the display with the IF CENTER FREQ controls. Tune the RF CENTER FREQUENCY if necessary to minimize interference from converted signals.

g. Connect a test oscilloscope through a 10x probe to pin B of the honeycomb square pin connector. Adjust the test oscilloscope sensitivity for a display amplitude of approximately 6 divisions then adjust the triggering controls for a stable display. See Fig. 6-25. (Test oscilloscope sweep rate should be the same as the analyzer sweep rate.)

h. Adjust 100 kHz Resol Cal R543 (Fig. 6-28) so the display begins to show evidence of over coupling (slight dip in the center). Bandpass response on the analyzer display should decrease to approximately 60 kHz at the -6 dB point when the RESOLUTION selector is turned counterclockwise one step from the fully clockwise position.

i. Set, the RESOLUTION selector fully clockwise. Adjust C504 and C508 (Fig. 6-27) for optimum display symmetry on the test oscilloscope See Fig. 6-25. Adjust C504 for the slope of the response and C508 for symmetry. Turn the RESOLUTION selector counterclockwise one step from fully clockwise position. Adjust C601, C604, C607 and C610 for optimum display symmetry and amplitude.

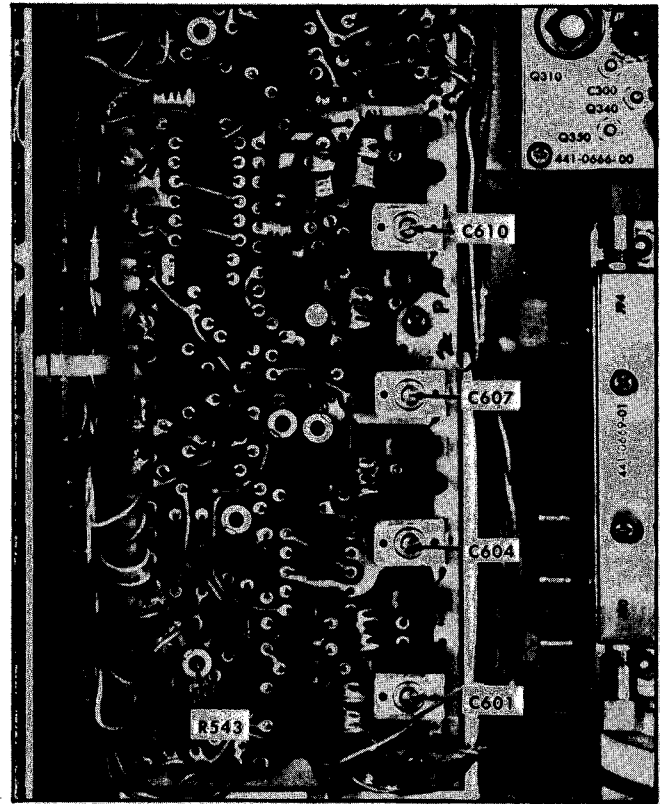

Fig. 6-28. location of resolution filter adjustments and 100 kHz Resolution Cal R543.

j. Check display symmetry through each position of the RESOLUTION selector. When these adjustments are correct, display will remain fairly symmetrical through the range of the selector. Remove the 10x probe and return the RESOLUTION selector to the fully clockwise position.

k. Check the Type 491 resolution bandwidth at the -6 dB point. (This point can be located by switching in the 2 and 4 dB IF ATTENUATOR dB switches and noting the display amplitude.) Bandwidth must equal or exceed 100 kHz at the -6 dB point.

l. If the bandpass is less than 100 kHz in step k, adjust the 100 kHz Resolution Cal R543 (Fig 2-28) to obtain a bandpass between 100 kHz and 120 kHz at the -6 dB point.

m. Turn the RESOLUTION control one position counterclockwise from the fully clockwise position (DISPERSION is 50 kHz.) Readjust the GAIN control for a full 8 division display and check the bandpass at the -6 dB point. Bandpass should decrease to approximately 60 kHz.

n. These adjustments interact. When properly set, the resolution bandwidth should vary from approximately 100 kHz, with the control in the full clockwise position, to 1 kHz or less with the RESOLUTION control in the fully counterclockwise position. As the DISPERSION is reduced to the 1 kHz/div position, the sweep rate must also be decreased to approximately .2 s/div to maintain a symmetrical response.

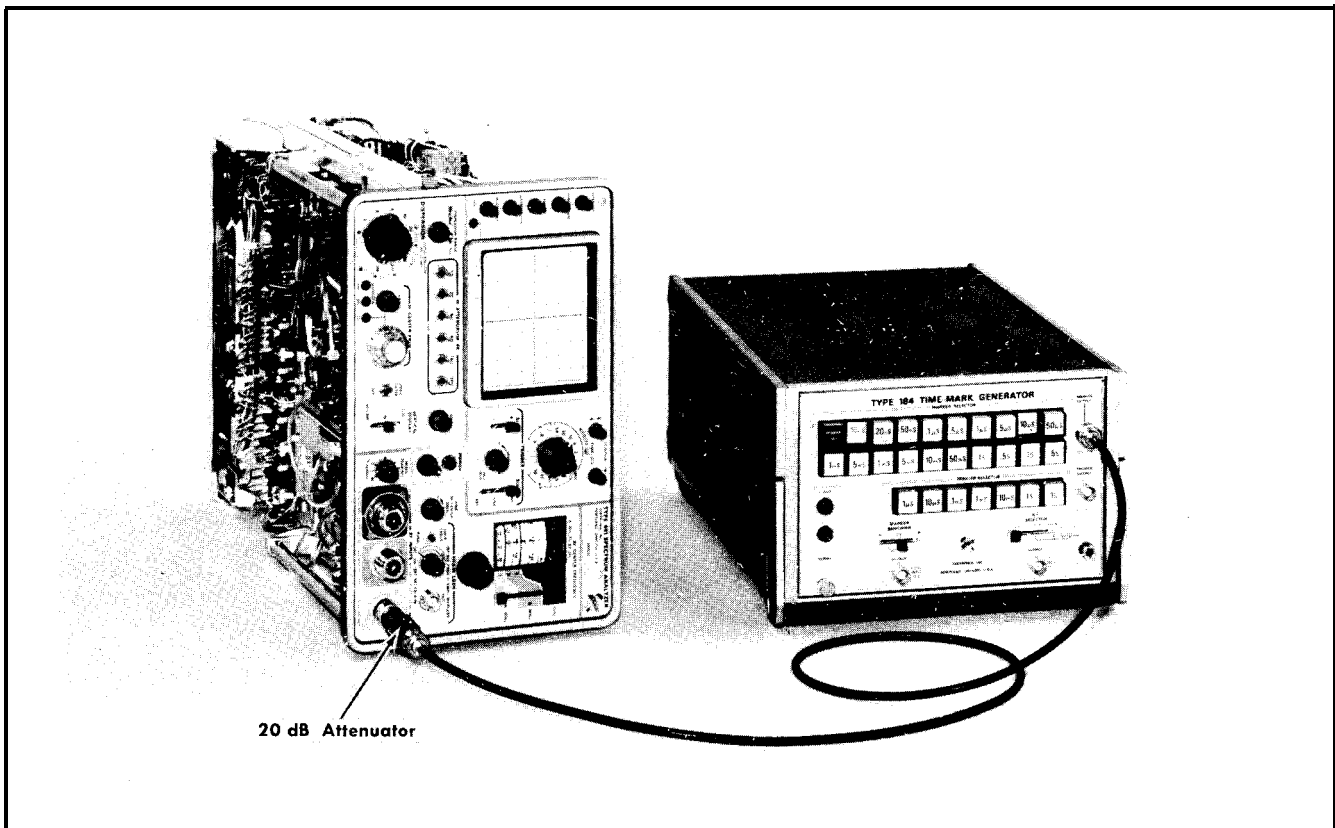

Fig. 6-29. Test equipment setup to adjust and check kHz/DIV dispersion accuracy.

**Type 491**

INTENSITY	Display of nominal brightness
FOCUS and ASTIGMATISM	Adjusted for optimum display definition.
SCALE ILLUM	As desired
POSITION (Horizontal and Vertical)	Adjusted for a horizontally centered sweep on the graticule baseline.
TIME/DIV	.1 s
VARIABLE	CAL
TRIGGER	
SLOPE	+
LEVEL	Triggered sweep
SOURCE	LINE
DISPERSION RANGE	kHz/DIV
DISPERSION-COUPLED	500 kHz/div
RESOLUTION	
IF ATTENUATOR dB	All switches in off position
IF CENTER FREQ	Midrange (000)
VIDEO FILTER	OFF
VERTICAL DISPLAY	LIN

OFF	VIDEO FILTER
GAIN	Midrange
POWER	ON
MIXER PEAKING	SEARCH
FINE RF CENTER FREQ	Centered
PHASE LOCK Controls	
INT REF FREQ	OFF

**24. Adjust kHz/DIV Dispersion**

a. Equipment setup is shown in Fig. 6-29.

**NOTE**

An alternate setup to check kHz/div dispersion is as follows: Replace the Coaxial Mixer for band C with the Waveguide Adapter. Apply the output of the Time-Mark Generator (Type 184) through a 20 dB attenuator and a BNC to TNC adapter to the band C RF INPUT. Switch the band selector to band C. This permits the direct application of an IF feedthrough signal. Markers down to 1 kHz/div can now be readily observed over the range of the IF CENTER FREQ control.

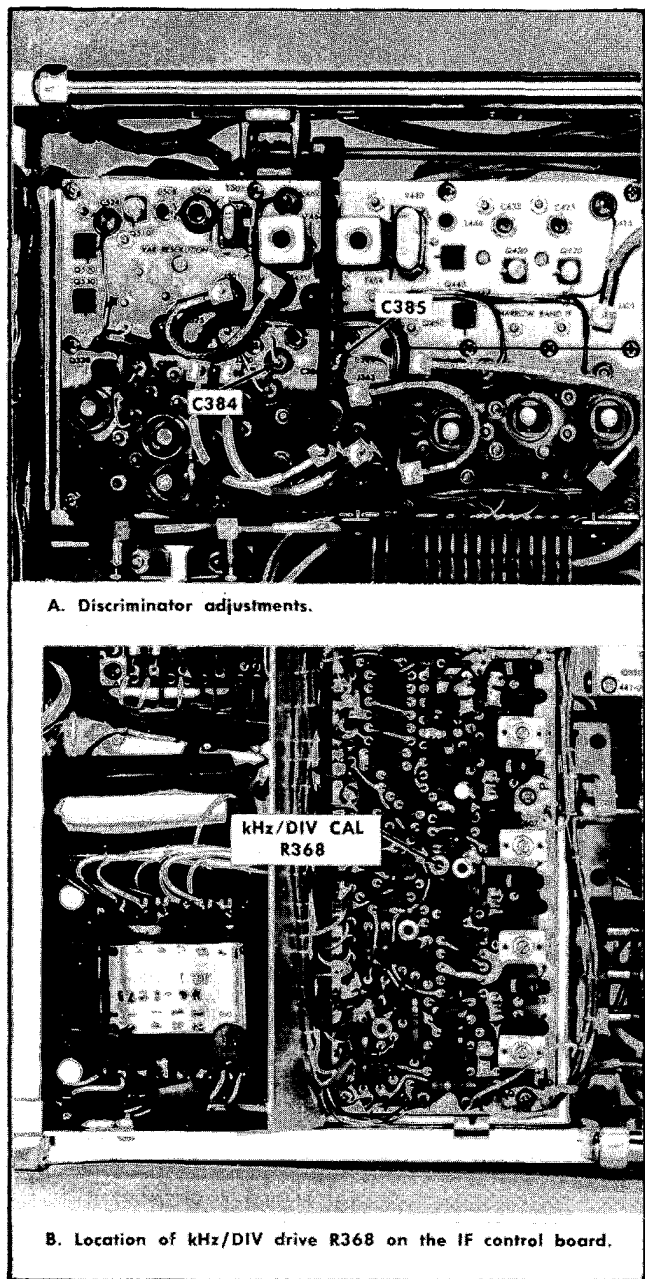

Fig. 6-30. Adjustments for the kHz/DIV discriminator.

b. Apply 10 ns and 1  $\mu$ s markers from the Time-Mark Generator through the 20 dB attenuator to the band A RF INPUT. Set the DISPERSION to 500 kHz/div. Preset the DISPERSION BAL R234, to its midrange position and the kHz/div Cal R368 (Fig. 6-30) approximately 90° counterclockwise from its fully clockwise position.

c. Adjust C384 and C385 simultaneously for 1 marker/2 div. Keep the IF feedthrough signal centered on the graticule as this adjustment is made.

d. Adjust the kHz/div Cal R368, for optimum dispersion linearity. These adjustments interact, so repeat the adjustments until optimum dispersion linearity and accuracy is obtained.

**NOTE**

An alternate source of frequency markers may be obtained by using the Harmonic Modulator (See equipment list) with a 100 MHz or 200 MHz source and an accurate audio signal source. Apply the RF signal to the RF Input and the audio frequency to the Mod Freq 1 Input of the Harmonic Modulator. Connect the Modu Harm Out connector through a 20 dB attenuator to the RF INPUT connector of the Type 491. This will provide an IF feedthrough signal modulated by the audio frequency for frequency markers.

**25. Check Dispersion of the kHz/div Selector Positions**

a. Test equipment setup is described in step 24.

b. Apply 10 ns and 1  $\mu$ s markers from the Time-Mark Generator through the 20 dB attenuator and proper adapter to band A RF INPUT or through the proper adapter to the Waveguide Adapter for band C. Set the band selector to the appropriate band and the DISPERSION selector to 500 kHz/div.

c. Check-The range of the IF CENTER FREQ control by rotating the control to the limits each side of center. Count the number of 1 MHz (1  $\mu$ s) markers from the 200 MHz (20 ns) feedthrough signal. Must equal or exceed 2.5 MHz. Note the dial reading when the control is 2.5 MHz from center. This reading will be used later in the procedure.

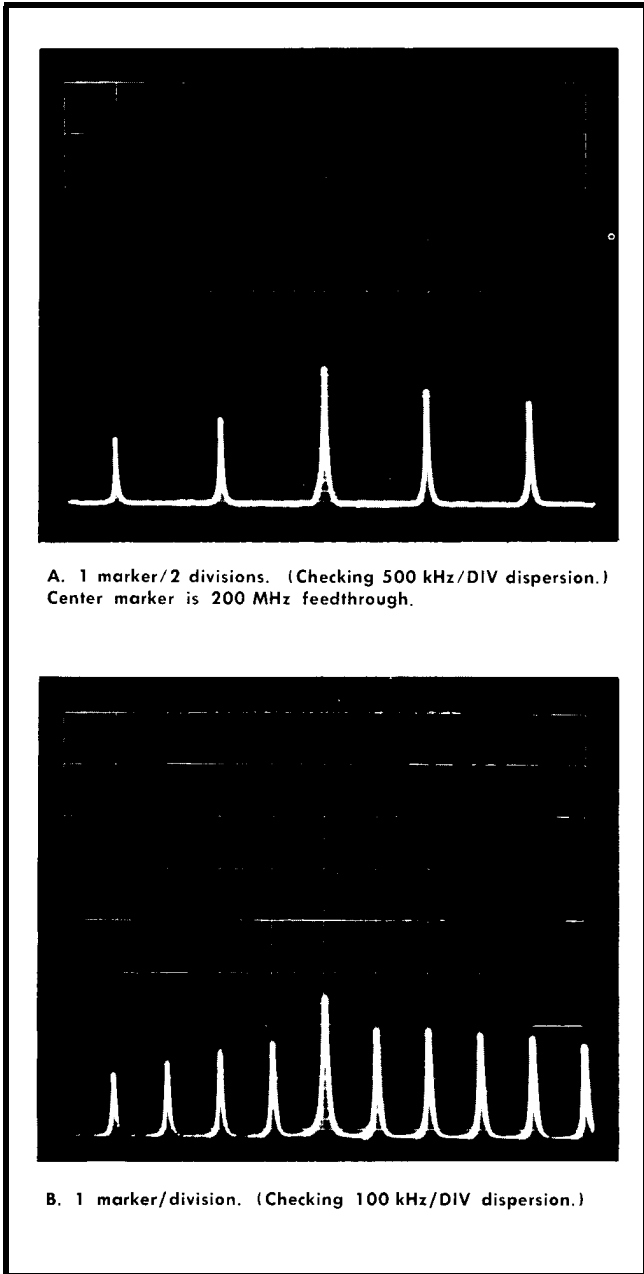

Fig. 6-31. Typical displays when checking or adjusting kHz/DIV

d. Center the IF CENTER FREQ controls and change the DISPERSION to 50 kHz/div.

e. Apply 10 ns and 10  $\mu$ s markers from the Time-Mark Generator to the RF INPUT.

f. Check the range of the IF CENTER FREQ-FINE control. Must equal or exceed 50 kHz either side of center.

g. Center the IF CENTER FREQ controls, change the DISPERSION back to 500 kHz/div and apply 10 ns and 1  $\mu$ s markers,

h. Check the dispersion accuracy (Fig. 6-31) at each DISPERSION selector position noted in Table 6-5.

Measure dispersion accuracy within the center 8 div of the display for each selector position and over the + and - 2.5 MHz range of the IF center frequency. Check the accuracy with the IF CENTER FREQ control centered, then rotate the control to the dial reading noted in step c for 2.5 MHz from center, and check the dispersion accuracy.

Decrease the sweep speed as the dispersion is decreased, and increase resolution by uncoupling the RESOLUTION selector. Turn the control counterclockwise to optimize marker definition. Switch the VERTICAL DISPLAY selector to LOG and the VIDEO FILTER on at these slower sweep rates and narrow dispersion settings.

i. Turn the VIDEO FILTER to OFF and the VERTICAL DISPLAY selector to LIN.

TABLE 6-5

DISPERSION kHz/DIV	Time-Mark Generator Marker Selector	Divisions per marker
500	10 ns and 1 $\mu$ s	2
200	10 ns and 5 $\mu$ s	1
100	10 ns and 10 $\mu$ s	1
50	10 ns and 10 $\mu$ s	2
20	10 ns and 50 $\mu$ s	1
10	10 ns and .1 ms	1
5	10 ns and .1 ms	2
2	10 ns and .5 ms	1
1	10 ns and .5 ms	2

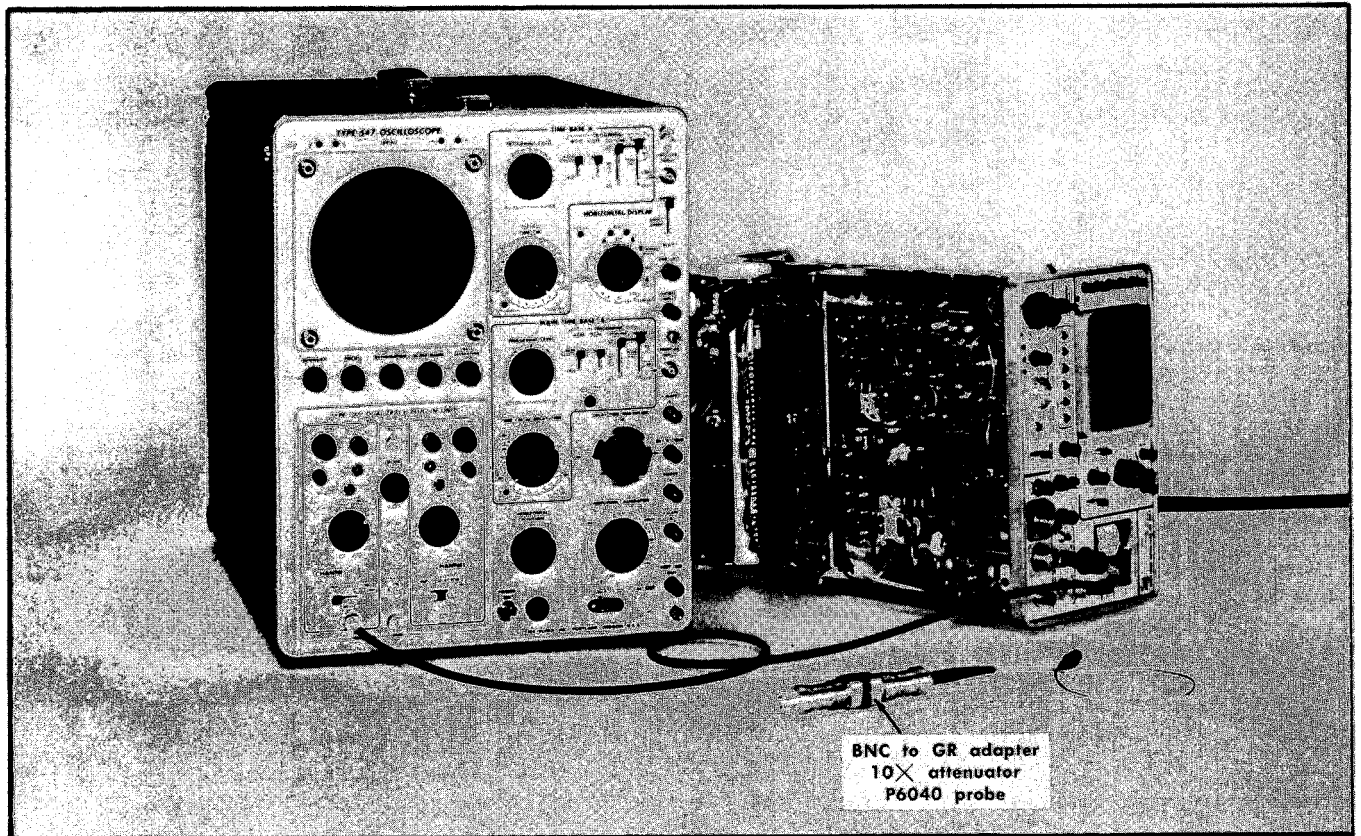

Fig. 4-32. Test equipment setup to check or adjust the phase lock circuit.

Type 491	
INTENSITY	Display of nominal brightness
FOCUS AND ASTIGMATISM	Adjusted for optimum display definition
SCALE ILLUM	As desired
POSITION (Horizontal and Vertical)	Adjusted for a horizontally centered sweep on the graticule baseline.
<b>TIME/DIV</b>	<b>2 ms</b>
VARIABLE	CAL
TRIGGER	
SLOPE	+
LEVEL	Triggered
SOURCE	LINE
DISPERSION RANGE	kHz/DIV
<b>DISPERSION-COUPLED RESOLUTION</b>	<b>50 kHz/div</b>
IF ATTENUATOR dB	All switches in off position
IF CENTER FREQ	Midrange (000)
VIDEO FILTER	OFF
VERTICAL DISPLAY	LIN
GAIN	Midrange
POWER	ON

MIXER PEAKING	SEARCH
FINE RF CENTER FREQ	Centered

#### PHASE LOCK Controls

INT REF FREQ	ON
--------------	----

#### Test Oscilloscope

Time/Cm	.5 $\mu$ s
Volts/Cm	.05
Input Coupling	AC
Triggering	Int.

#### Phase Lock Circuit

### 26. Adjust Avalanche Voltage ❶

a. Equipment setup is given in Fig. 6-32.

b. Connect the Vertical Input of the test oscilloscope to the 1 MHz MARKERS OUT connector and turn the INT REF FREQ control on.

c. Adjust the test oscilloscope for a triggered display. See Fig. 6-33B.

d. Adjust the Avalanche Volts R1131. (Fig. 6-33), from a fully ccw position, clockwise until the avalanche transistor is

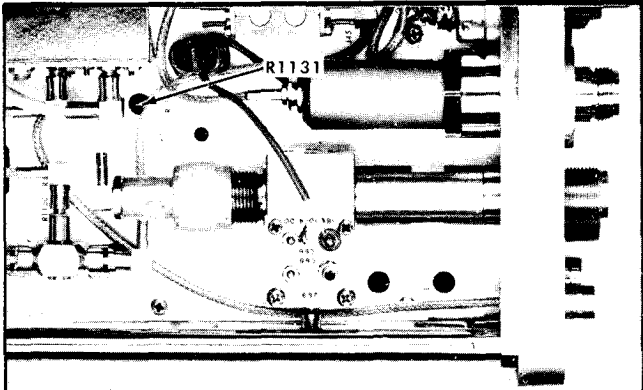

A. Location Avalanche Volts R1131 Adjustment.

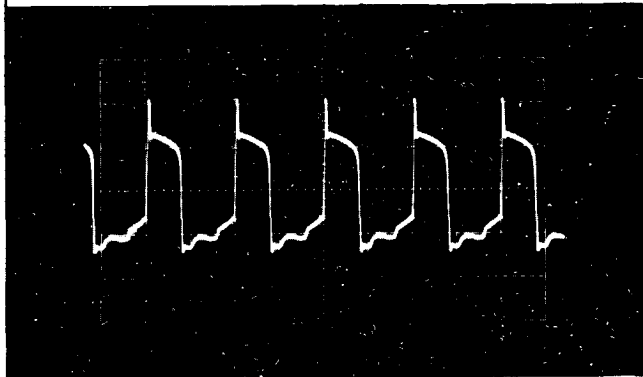

B. Avalanche voltage correctly adjusted. Stable 1 MHz display.

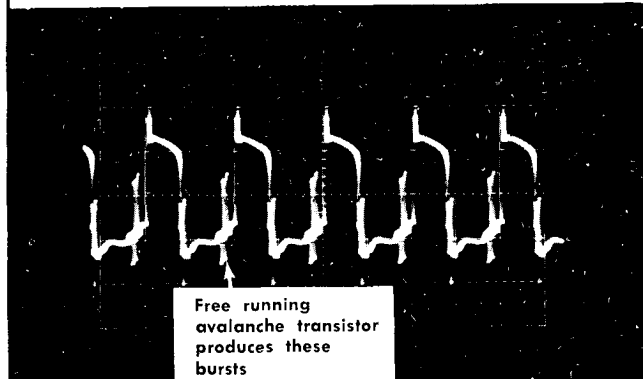

C. Avalanche voltage misadjustment avalanche transistor oscillating.

Fig. 6-33. Adjusting avalanche voltage.

just below the state of free running avalanche. Free running avalanche, appears as an RF burst signal between the 1 MHz pulses as shown in Fig. 6-33C; or with the INT REF FREQ control in the OFF position, the free running avalanche transistor signal will feed through to the 1 MHz MARKERS OUT connector, and appear on the test oscilloscope as a 2 MHz burst. If free running avalanche does not occur, turn the adjustment fully clockwise.

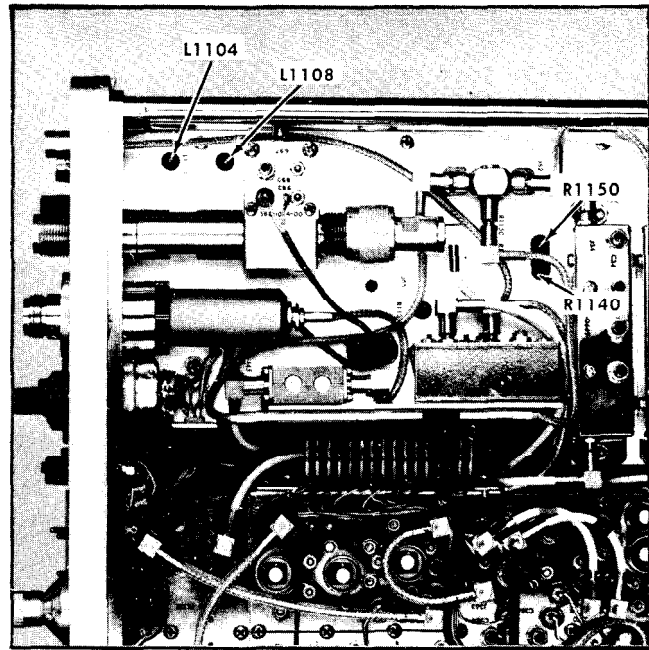

Fig. 6-34. Location of L1104 and 1108, R1150 and R1140.

e. Switch the band selector to band C. Turn the INT REF FREQ control on.

f. Push the LOCK CHECK button. Check for beat signal displays as the FINE RF CENTER FREQ control is rotated through its range.

## 27. Adjust 1 MHz REF FREQ Range ①

a. Equipment set up is given in step 26.

b. Apply the output from the 1 MHz MARKERS OUT signal through a 10x attenuator to J120 on the honeycomb assembly as follows: Connect a GR to Sealectro adapter (such as a P6040 probe cable), a GR to BNC adapter and a 20 dB attenuator, (see Fig. 6-32) between the 1 MHz MARKERS OUT connector and J120. Disconnect the Sealectro connector from J120.

c. Set the DISPERSION to 100 kHz/Div and position a 1 MHz marker to the screen center with the IF CENTER FREQ control.

d. Adjust L1108 (Fig. 6-34) for a positive oscillator start when the INT REF FREQ control is turned from its OFF to ON position. The signal position on the screen should be consistent as the INT REF FREQ control is switched from OFF to the initial ON position. (The control must not be turned past the initial ON position or the oscillator frequency will be changed.)

e. Rotate the INT REF FREQ control through its range Check the total frequency shift of the internal reference 1 MHz marker.

f. Adjust L1104 (Fig. 6-34) until the oscillator shift range, as the INT REF FREQ is rotated, is 1.2 kHz. The display is the 200th harmonic of the 1 MHz signal. The range of the INT REF FREQ control will also be related to the 200th harmonic, so  $1.2 \text{ kHz} \times 200 = 240 \text{ kHz}$ . With  $100 \text{ kHz/Div}$  dispersion this will equal 2.4 divisions.

g. Remove the P6040 Probe, attenuator and adapters, then reconnect the coaxial cable between J120 and J109.

## 28. Adjust Band C Balance then Band A and B Balance

a. Equipment setup is as given for step 26.

b. Turn the INT REF FREQ control ON and the band selector to band C.

c. Set the FINE RF CENTER FREQ control to its midrange position.

d. Push the LOCK CHECK button and adjust the Band C Bal R1140 for a centered trace.

e. Switch the band selector to B or A.

f. Push the LOCK CHECK button and adjust the A and B Bal R1150 for a centered trace,

g. Check the DC balance between the level for band A or B to band C by switching the band selector between B and C. Adjust A and B, DC level to set level for band C.

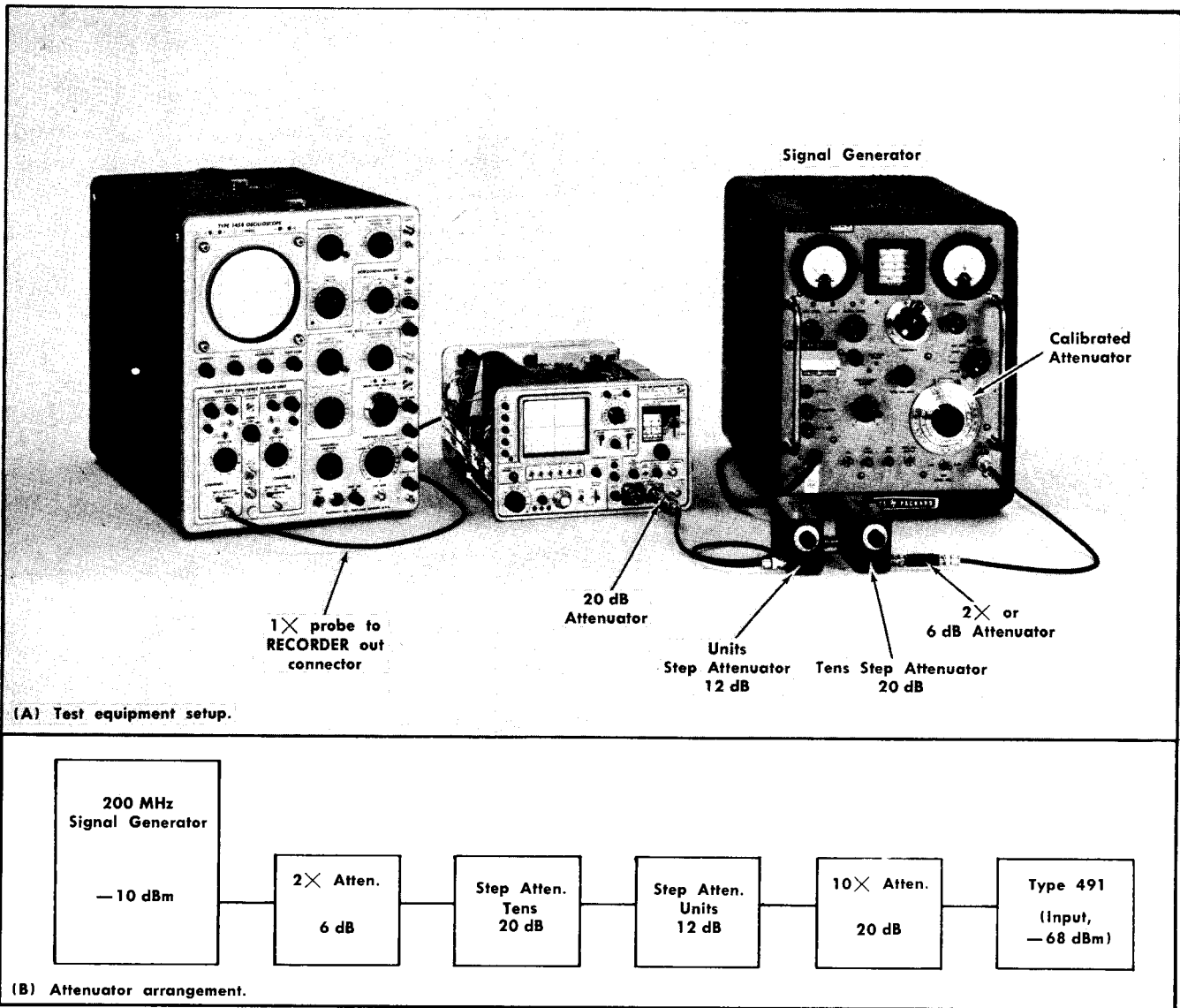

Fig. 6-35. Test equipment setup to check dynamic range, IF GAIN control range, IF ATTENUATOR dB accuracy RECORDER signal out amplitude and incidental FM.

### Type 491

INTENSITY	Display of nominal brightness
FOCUS and ASTIGMATISM	Adjusted for optimum display definition
INTENSIFIER	OFF
SCALE ILLUM	As desired
POSITION (Horizontal and Vertical)	Adjusted for a horizontally centered sweep on the graticule baseline.
TIME/DIV	10 ms
VARIABLE	CAL
TRIGGER	
SLOPE	+

LEVEL
SOURCE
DISPERSION RANGE
DISPERSION-COUPLED
RESOLUTION
IF ATTENUATOR dB
IF CENTER FREQ
VIDEO FILTER
VERTICAL DISPLAY
GAIN
POWER
MIXER PEAKING
FINE RF CENTER FREQ
PHASE LOCK Controls
INT REF FREQ

FREE RUN
INT
kHz/DIV
500 kHz/div
All switches in off position
Midrange (000)
OFF
LIN
Midrange
ON
SEARCH
Centered
OFF



## 29. Check Dynamic Range of Vertical Display Modes

- a. Equipment setup is shown in Fig. 6-35.
- b. Apply a 200 MHz signal from an RF Signal Generator with a calibrated variable output attenuator to band A RF INPUT connector. Signal amplitude should be less than -40 dBm
- c. Adjust the GAIN control and the Variable Output Attenuator for a display amplitude on the Type 491 of 8 divisions.
- d. Increase the output attenuation of the Signal Generator until the signal is just visible (about 0.5 minor divisions). Note the difference in attenuator reading between the full screen display and the 0.5 minor division display.
- e. Check the dynamic range of each VERTICAL DISPLAY switch mode to the following specifications:

LIN;  $\geq 26$  d B

LOG;  $\geq 40$  d B

SQ LAW;  $\geq 13$  d B

## 30. Check Accuracy of IF ATTENUATOR dB Selectors

Accuracy of the IF ATTENUATOR dB selectors is checked at the factory to insure they are within the 0.1 dB/dB specification. Any change in this tolerance should be a large one and due to component failure. Step attenuators with rigid specifications are, therefore, not recommended. However, if the user desires to precisely measure the error of the dB selectors, he must accurately calibrate the recommended equipment or use an attenuator with more rigid specification.

- a. Equipment setup is shown in Fig. 6-35.
- b. Apply a 200 MHz signal, that is 10 dB below 1 mW, from the signal generator through a 2x Attenuator (6 dB), a Tens and Units Step Attenuator and a 10x Attenuator (20 dB) to the Type 491 RF INPUT connector.
- c. Set the Tens Step Attenuator for 20 dB and the Units Step Attenuator for 12 dB attenuation.
- d. Adjust the GAIN control for a signal amplitude of 6 divisions on the analyzer.
- e. Check the accuracy of the IF ATTENUATOR dB selectors as follows:
  1. Switch the 1 dB ATTENUATOR switch to on and switch out 1 dB attenuation through the Units Step Attenuator.
  2. Check the display amplitude. Must equal 6 divisions  $\pm 0.7$  minor divisions.
  3. Switch the 1 dB ATTENUATOR switch to the OFF position, then check the remaining IF ATTENUATOR dB steps as directed in Table 6-6a.

TABLE 6-6a

Spectrum Analyzer IF ATTENUATOR Switch on	Step Attenuators		Signal Amplitude Limit (.1 dB/dB)
	Units	Tens	
1 dB	11	20	5.93 to 6.07 div
2 dB	10	20	5.86 to 6.14 div
4 dB	8	20	5.7 to 6.3 div
8 dB	4	20	5.5 to 6.6 div
16 dB	6	10	5.0 to 7.2 div
20 dB	2	10	4.8 to 7.5 div

The 1 and 2 dB measurements are very difficult because of signal stability and the noise level. Over these small levels the square law mode may be used. This expands the screen changes for the same level change by the square power as listed in Table 6-6b. Use reference signal amplitude of 5 divisions to avoid going outside the graticule area.

TABLE 6-6b

dB	1	2	4	8	16	20
Signal	4.96	4.75	4.5	4.0	2.8	2.0
Amplitude	to	to	to	to	to	to
limits	5.06	5.25	5.5	6.0	7.3	8.0

An alternate method which is not as accurate but is sufficient for most applications is as follows:

1. Apply a -60 dBm, 200 MHz signal from the signal generator to the RF INPUT connector. Adjust the Spectrum Analyzer GAIN control for a signal amplitude of 5 divisions.
2. Switch the 1 dB ATTENUATOR switch on and adjust the signal generator Attenuator control to return the signal amplitude to 5 divisions.
3. Check the new reading of the Attenuator dial. Should read -50 dBm  $\pm 0.1$  dBm.
4. Turn the 1 dB ATTENUATOR switch to OFF. Check the remainder of the IF ATTENUATOR selector steps as directed in Table 6-6c.

TABLE 6-6c

Spectrum Analyzer IF ATTEN switch ON	RF Generator Attenuator Control Setting
2 dB	-58 dBm $\pm .2$ dBm
4 dB	-56 dBm $\pm .4$ dBm
8 dB	-52 dBm $\pm .8$ dBm
16 dB	-44 dBm $\pm 1.6$ dBm
20 dB	-40 dBm $\pm 2.0$ dBm

## 31. Check Attenuation Range of IF GAIN Control

- a. Equipment setup is given in step 30.
- b. Turn the GAIN control fully counterclockwise. Adjust the Signal Generator variable output attenuator for an 8

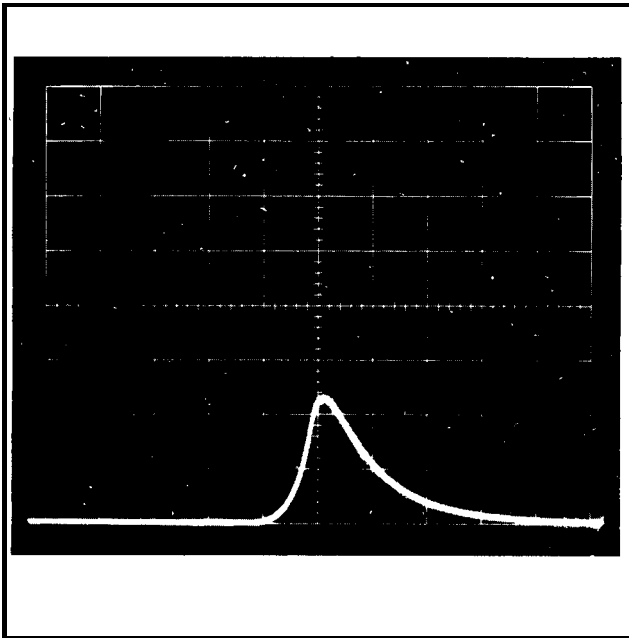

Fig. 6-36. Typical Video Filter integrated display of 200 MHz RF

division signal amplitude on the Type 491. Note the dBm reading of the Signal Generator attenuator dial, increase the variable output attenuation of the Signal Generator 50 dB. Adjust the GAIN control for a 8 division display.

c. Check—Range of GAIN control must equal or exceed 50 dB.

#### NOTE

If the IF GAIN control does not meet this requirement, perform step 36 then recheck.

### 32. Check INTENSIFIER Control Range

- a. Test equipment setup is given in step 29.
- b. Change the DISPERSION selector to 100 kHz/div. Uncouple the RESOLUTION control and turn the control fully clockwise (maximum resolution bandwidth).
- c. Set the VERTICAL DISPLAY switch to LOG position then adjust the GAIN control and the Signal Generator output for a signal amplitude of approximately 8 divisions.
- d. Turn the INTENSIFIER control to the OFF position (fully c.c.w). Set the INTENSIFIER control for a display of nominal brightness. Set the CONTRAST adjustment to midrange.
- e. Turn the INTENSIFIER control fully c.w. The intensified portion of the signal should measure between 3.5 and 4.5 major divisions.

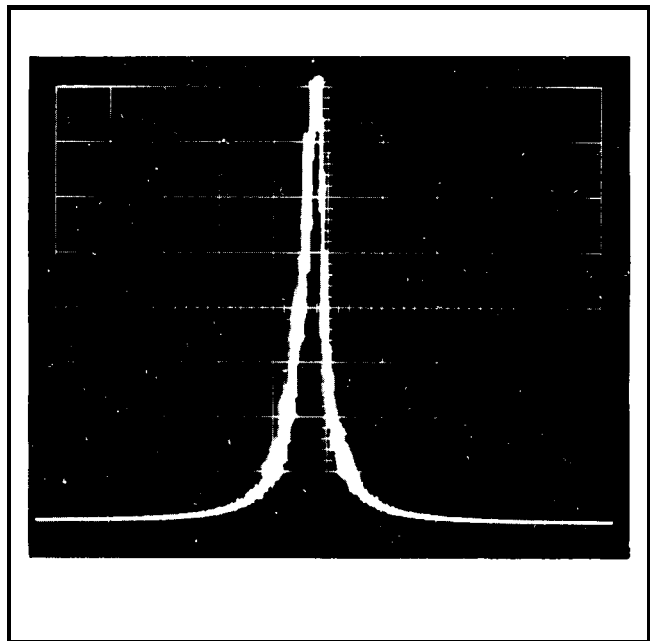

Fig. 6-37. Typical display showing incidental frequency modulation,

### 33. Check Signal Amplitude at the TO RECORDER Connector

- a. Equipment setup is given in step 29.
- b. Set the VERTICAL DISPLAY switch to the LIN position, adjust the Signal Generator output and the Type 491 GAIN control for a signal amplitude of 6 divisions.
- c. Connect a 1x probe from the test oscilloscope to the TO RECORDER connector on the back panel. Terminate the connector into a 600 W load by connecting a 600 W resistor from the TO RECORDER lack to ground.
- d. Check—Signal amplitude should equal or exceed 24 mV ( $\geq 4$  mV division of displayed signal amplitude).

### 34. Check Video Filter Operation

- a. Equipment setup is given in step 33.
- b. With the DISPERSION selector at 100 kHz/DIV and the TIME/DIV at 5 ms, uncouple the RESOLUTION control and turn counterclockwise one position from the full clockwise position.
- c. Turn the VIDEO FILTER switch ON.
- d. Check—The display should resemble Fig. 6-36.
- e. Decrease the TIME/DIV to .5 s position and check the display. There should be no appreciable change in the display, when the FILTER is switched ON or OFF, unless there is noise in the display. Set the FILTER to the OFF position.

### 35. Check Incidental Frequency Modulation

#### NOTE

Signal source must supply a very stable 200 MHz signal to accurately measure incidental FM and the Type 491 must be on a vibration-free platform.

- a. Equipment setup is given in step 34.
- b. Set the DISPERSION RANGE switch to kHz/DIV and the DISPERSION to 500 kHz/div. Set the TIME/DIV to .1 s.
- c. Apply a 200 MHz signal from the Time-Mark Generator through a 20 dB attenuator to band A RF INPUT connector and center the IF feedthrough signal on screen.
- d. Change the DISPERSION-COUPLED RESOLUTION to 1 kHz/div, adjusting the IF CENTER FREQ control to keep the signal centered on screen.
- e. Adjust the GAIN control for an 8 division signal amplitude.
- f. Check the display frequency modulation (see Fig. 6-37). Must not exceed 1 minor division ( $\leq 200$  Hz).
- g. Change the DISPERSION to 100 kHz/div and move the IF feedthrough signal off screen with the IF CENTER FREQUENCY control. Center the tunable 200 MHz signal on screen with the RF CENTER FREQUENCY controls.
- h. Turn the INT REF FREQ on and phase lock the display. See Operating Instructions.
- i. Decrease the DISPERSION to 1 kHz/div, keeping the phase locked signal on screen with the IF CENTER FREQ controls.
- j. Check the frequency modulation of the display. Must not exceed 1.5 minor divisions (300 Hz).
- k. Return the DISPERSION-COUPLED RESOLUTION controls to 500 kHz/div.

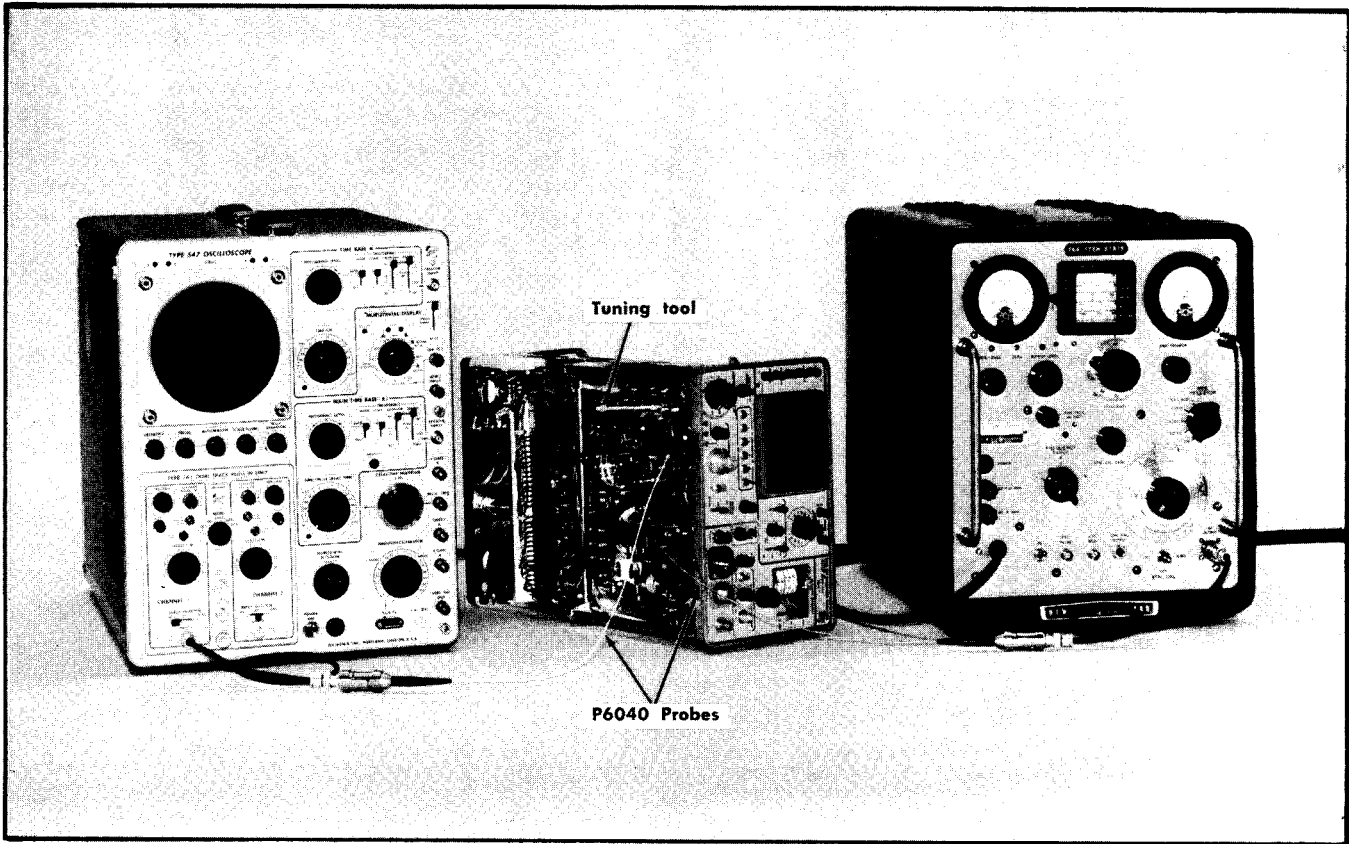

Fig. 6-38. Equipment setup to adjust wide band IF amplifier and check flatness.

### Type 491

INTENSITY	Display of nominal brightness
FOCUS and ASTIGMATISM	Adjusted for optimum display definition.
SCALE ILLUM	As desired
POSITION (Horizontal and Vertical]	Adjusted for a horizontally centered sweep on the graticule baseline
<b>TIME/DIV</b>	<b>20 ms</b>
VARIABLE	CAL
TRIGGER	
SLOPE	+
LEVEL	FREE RUN
SOURCE	INT
<b>DISPERSION RANGE</b>	<b>MHz/DIV</b>
<b>DISPERSION-COUPLED RESOLUTION</b>	<b>5 MHz/DIV</b>
IF ATTENUATOR dB	20 dB switch on
IF CENTER FREQ Controls	Midrange (000)
VIDEO FILTER	OFF
VERTICAL DISPLAY	LIN
<b>GAIN</b>	<b>Midrange</b>
POWER	<b>O N</b>
MIXER PEAKING	Manual

FINE RF CENTER FREQ	Centered
PHASE LOCK Controls	
INT REF FREQ	O N

### Test Oscilloscope

<b>Time/Cm</b>	<b>1 ms</b>
<b>Volts/Cm</b>	<b>.005</b>
Input Coupling	AC
Trigger	Int

### 36. Adjust the Wide Band Amplifier Response and Check the System Response Flatness ①

#### NOTE

The Type 491 response flatness and sensitivity is dependent on the combined response of the wide band amplifier, the bandpass filter, the low pass filters and the RF mixer. Each circuit assembly must be adjusted as part of the complete system, since the circuit response for each unit is dependent on the impedance presented by the preceding and following circuit.

The low-pass and bandpass filters should require recalibration only after circuit components have been replaced. If recalibration is required, the analyzer should be returned to Tektronix for cali-

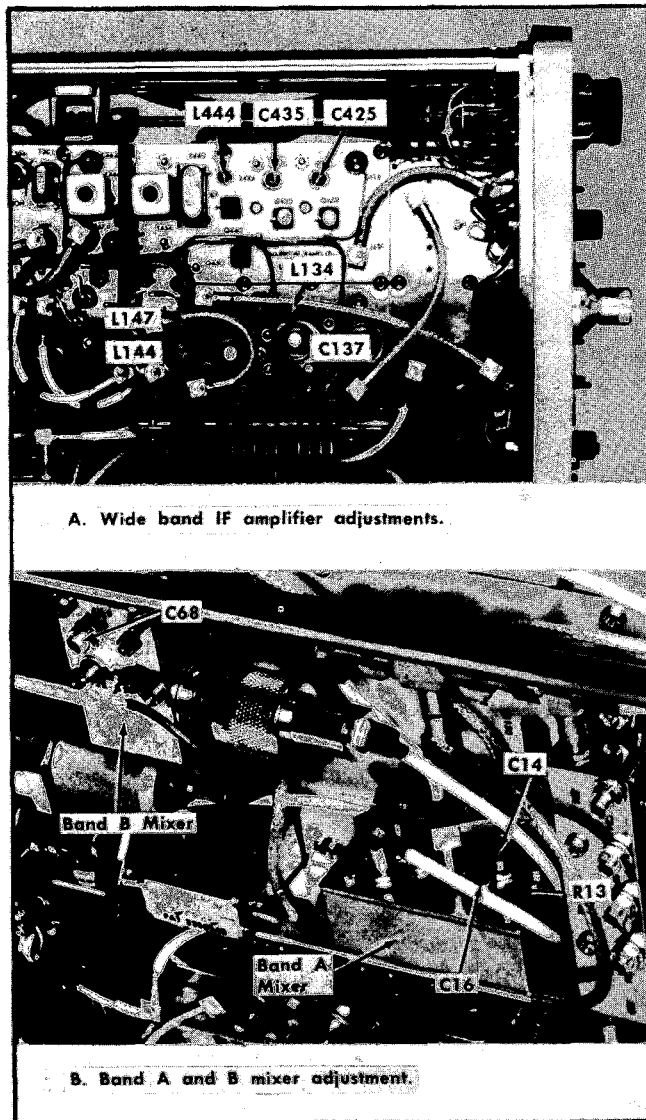

Fig. 6-39. Wide band IF and Mixer tuning adjustments.

bration. These filters require special test equipment and technique to calibrate. Contact your local Tektronix Field Office or representative.

This procedure does not require a Sweep Generator, however, a Sweep Generator such as the Kay Model 121 C Multi-Sweep Generator may be used to check flatness.

a. Equipment setup is given in Fig. 6-38.

b. Disconnect the cable connector from J120 on the honeycomb assembly and apply a calibrated 65 MHz signal ( $-30$  dBm) from the signal generator to J120 as described in step 23.

c. Disconnect the cable connector from J188 (output of the IF Attenuator). Connect the output of J188 through a subminiature to BNC adapter and coaxial cable to the Vertical connector of the test oscilloscope.

d. Turn the 20 dB ATTENUATOR switch for the Type 491 to the ON position. Adjust the variable output attenuator on the signal generator for an approximate 3 mV display amplitude on the test oscilloscope.

e. Adjust L147 (Fig. 6-39), the 65 MHz trap, for minimum response to the 65 MHz signal.

f. Remove the signal generator signal and the test oscilloscope connection. Reconnect the Sealectro connectors and cables to J120 and J188.

9. Apply a calibrated signal within the frequency range of band B through a 20 dB attenuator (Part No. 011-0086-00) to band B RF INPUT connector.

h. Set the Dispersion to 10 MHz/div. Tune the RF center frequency to the applied signal frequency. Adjust the MIXER PEAKING for maximum signal amplitude. Adjust the GAIN plus the variable attenuator of the signal generator for a signal amplitude of 6 divisions.

i. Calibrate the output amplitude of the RF signal from the signal generator.

j. Tune the signal generator frequency through a 100 MHz band and check the response flatness of the Type 491. Signal amplitude should not vary over  $\pm 1.5$  dB, or a total of 3 dB from the maximum to minimum amplitude point, with a constant amplitude input signal to the RF INPUT connectors. Adjust the MIXER PEAKING for maximum signal amplitude for each display window.

#### NOTE

This is not a conclusive check because the local oscillator power may vary over this frequency range. Try other input frequencies and oscillator frequency ranges.

k. If the response flatness is not within tolerance, adjust C137 and L134 (Fig. 6-39) for optimum sensitivity and flatness. Adjusting C137 will produce a noticeable affect on the response slope. Adjust L134 for optimum sensitivity at the high frequency end of the response.

l. Increase the signal generator frequency to 800 MHz and tune the Type 491 to this frequency.

m. Adjust the MIXER PEAKING control for maximum signal amplitude.

n. Adjust C68 (Fig. 6-39) on the band B RF mixer for optimum sensitivity and bandpass flatness. Tune the signal across the screen with the RF CENTER FREQUENCY control to check flatness.

o. Check the display flatness over the frequency range of the instrument as follows:

#### NOTE

Each time the signal generator frequency is changed it will be necessary to recalibrate the output amplitude.

1) Set the front panel controls as follows:

RF CENTER FREQUENCY	10 MHz
DISPERSION RANGE	MHz/DIV
DISPERSION	5 MHz/div
IF ATTENUATOR	20 dB
VERTICAL DISPLAY	LIN
TIME/DIV	5 ms
Band Selector	A

2) Apply the output signal from a signal generator within the frequency range of band A, to the band A RF INPUT connector.

3) Set the generator frequency and the RF center frequency to the frequencies that are listed in Table 6-7. Adjust the signal generator output attenuator and the Type 491 GAIN control for a signal amplitude of 6 divisions.

4) Check band A display flatness by tuning the signal from the display screen left edge to the right edge with the RF CENTER FREQUENCY control. (Frequency range + and -25 MHz of the RF center frequency.) Signal amplitude should not change more than  $\pm 1.5$  dB from its average amplitude or 3 dB total.

TABLE 6-7

RF Center Frequency	Applied Signal Generator Freq.
10 MHz-60 MHz	35 MHz
50 MHz-100 MHz	75 MHz
100 MHz-150 MHz	125 MHz
150 MHz-200 MHz	175 MHz
200 MHz-250 MHz	225 MHz
250 MHz-275 MHz	275 MHz

5) Remove the signal to band A, RF INPUT and apply a signal within the frequency range of band B to RF INPUT

B. Set the band selector to B and set the DISPERSION to 10 MHz/div.

TABLE 6-8

RF Center Frequency	Applied Signal Generator Freq.
275 MHz-375 MHz	325 MHz
375 MHz-475 MHz	425 MHz
475 MHz-575 MHz	525 MHz
575 MHz-675 MHz	625 MHz
675 MHz-775 MHz	725 MHz
775 MHz-875 MHz	825 MHz
875 MHz-900 MHz	850 MHz

6) Check display flatness as per Table 6-8. 3 dB maximum amplitude variation over 100 MHz window ( $\pm 50$  MHz from RF center frequency). Maximum signal amplitude with the MIXER PEAKING control before measuring flatness.

7) Remove the signal from band B INPUT and apply the output from signal generators, that cover scales 4 through 6 frequency range, to band C Coaxial Mixer.

8) Check response flatness through the frequency range of the Coaxial Mixer. Maximum amplitude variation over 100 MHz dispersion window must not exceed 3 dB. Adjust MIXER PEAKING for maximum signal amplitude before measuring flatness.

9) Replace the Coaxial Mixer with the Waveguide Mixer Adapter.

10) Apply the output from o signal generator, within the frequency range of scale 8 and 9 through one of the Waveguide Mixers and the 2 foot cable (with the BNC connectors) to band C Waveguide Adapter.

11) Check response flatness for the frequency range above 12.4 GHz. Maximum amplitude variation over 100 MHz dispersion window must not exceed 6 dB. Adjust Mixer PEAKING for maximum signal amplitude before measuring flatness.

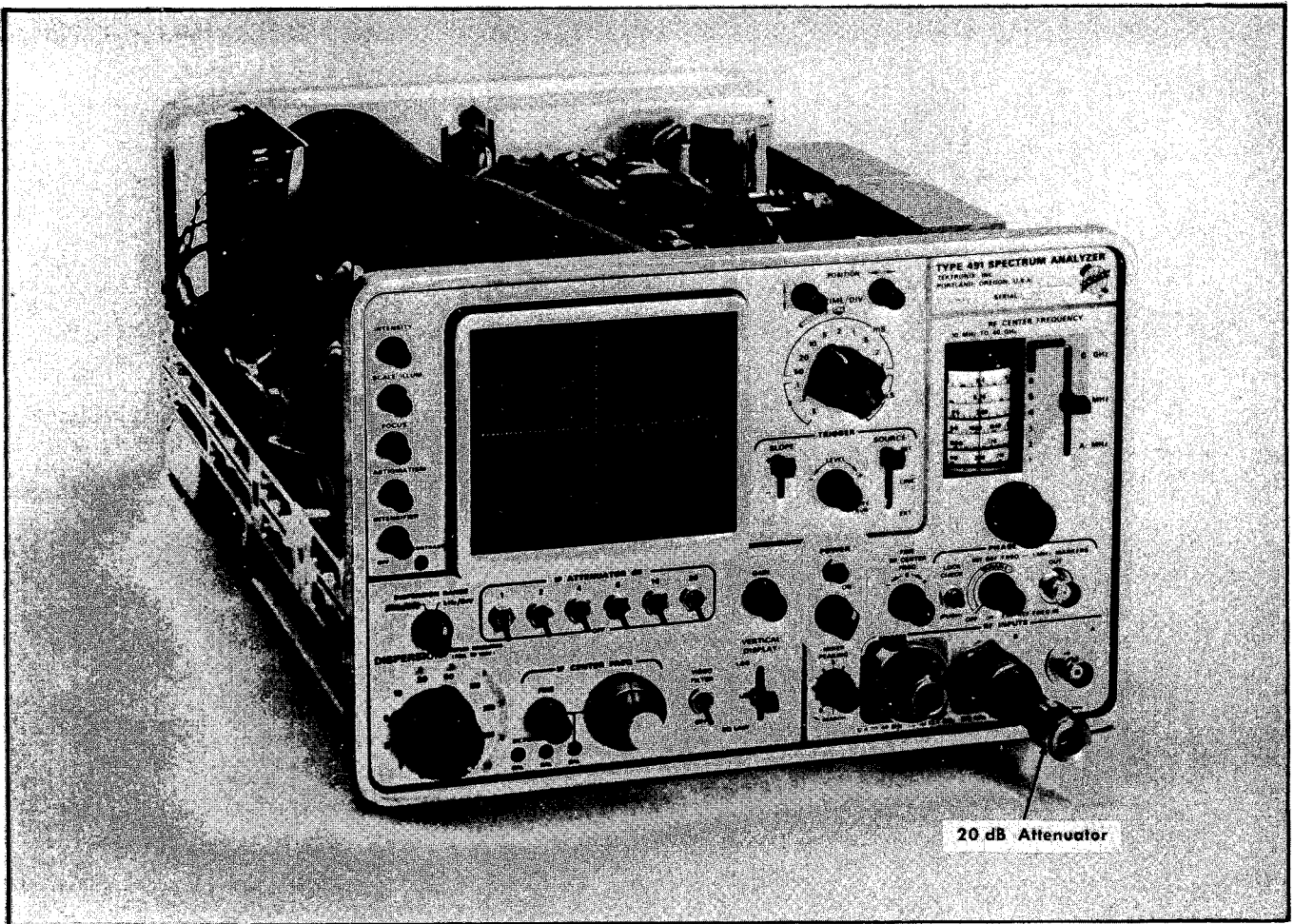

Fig. 6-40. Equipment setup to check internal spurious responses.

	Type 491		
INTENSITY	Display of nominal brightness	DISPERSION RANGE	MHz/DIV
FOCUS & ASTIGMATISM	Adjusted for optimum display definition	DISPERSION	2
SCALE ILLUM	As desired	RESOLUTION	Fully CW
POSITION (Horizontal and Vertical)	Adjusted for a horizontally centered sweep on the graticule baseline	IF ATTENUATOR dB	20
TIME/DIV	5 ms	IF CENTER FREQ	Midrange (000)
VARIABLE	CAL	VIDEO FILTER	OFF
TRIGGER SLOPE	+	VERTICAL DISPLAY	LIN
LEVEL	FREE RUN	GAIN	Midrange
SOURCE	INT	POWER	ON
		MIXER PEAKING	SEARCH
		FINE RF CENTER FREQ	Centered
		PHASE LOCK Controls	
		INT REF FREQ	OFF

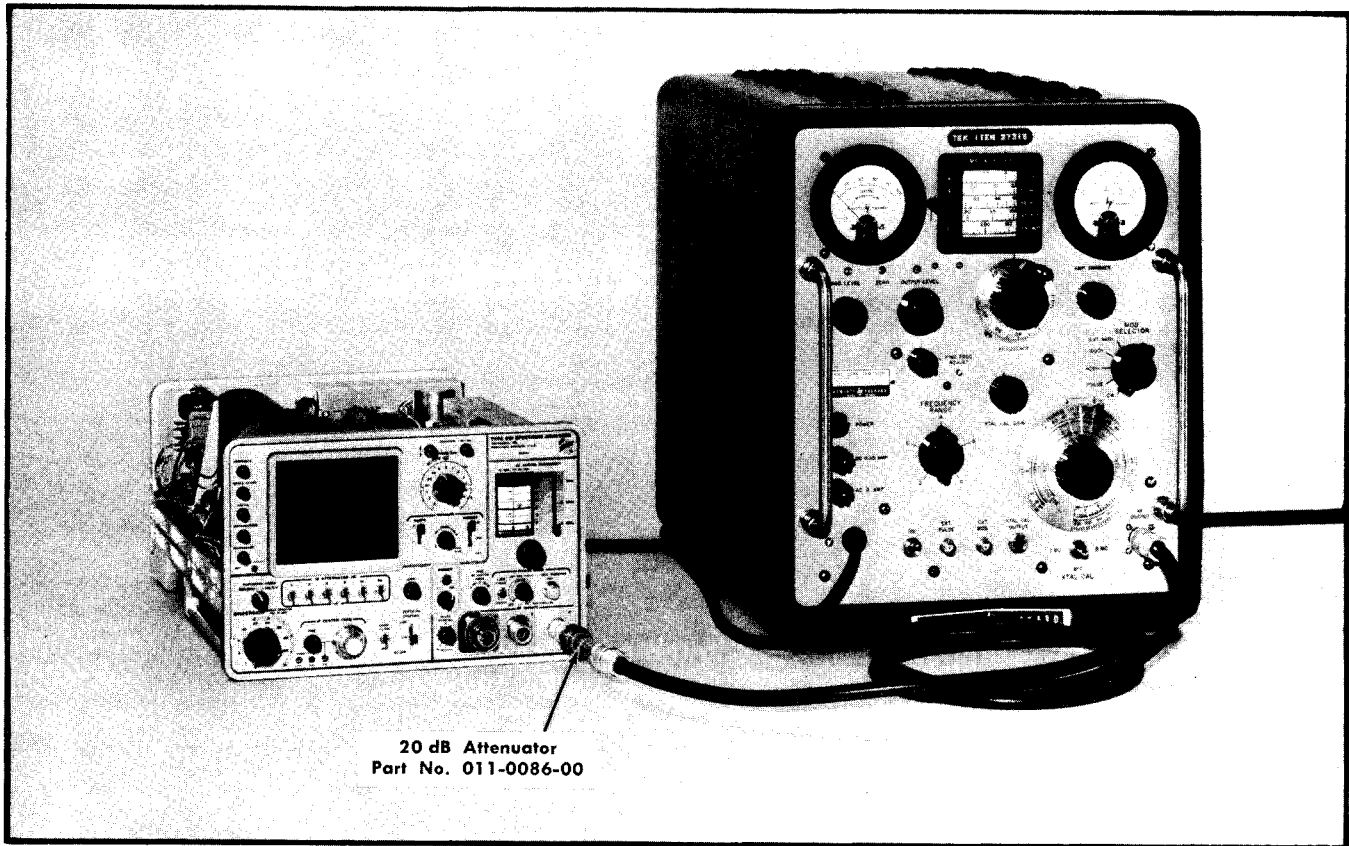

Fig. 6-41. Typical equipment setup to check response flatness, sensitivity, frequency calibration and phase lock operation.

### 37. Adjust Band A Mixer Balance—Check Amplitude of Spurious Signals from Internal Sources

- a. Equipment setup is shown in Fig. 6-40.
- b. Connect a  $50\ \Omega$  termination to band A RF INPUT connector. Switch the band selector to A.
- c. Adjust the GAIN control so noise amplitude is about 1 division.
- d. Tune the RF CENTER FREQUENCY to the low end of the dial against the stop. At this center frequency setting with a dispersion of 2 MHz/div, a local oscillator feedthrough spur should be visible on the display.
- e. Tune the RF CENTER FREQUENCY to center the feedthrough spur, then decrease the dispersion to 1 MHz/div.
- f. Adjust C14, C16 and R13 (band A mixer, see Fig. 6-39) to minimize the amplitude of this feedthrough spur over the 5 MHz dispersion window.
- g. Check through band A frequency range for spurious signals. Amplitude of any spur with the exception of the local oscillator feedthrough signal must not exceed  $2\times$  noise amplitude. If a spur appears at approximately 37.5 MHz, readjust the mixer balance.

- h. Move the  $50\ \Omega$  termination to band B RF INPUT connector, switch the band selector to B and set the DISPERSION to 10 MHz/div.

- i. Adjust the GAIN control for 1 division of noise, then tune through the band B frequency range checking for spurious signals whose amplitude exceeds  $2\times$  noise level.

- j. Move the  $50\ \Omega$  termination to band C RF INPUT connector. Set the band selector to C.

- k. Check through the frequency range of band C for spurious signals with amplitudes that should exceed  $2\times$  noise level.

### 38A. Check Dial Accuracy, Analyzer Sensitivity and Local Oscillator Phase Lock Operation

#### NOTE

Since signal generators with calibrated attenuators are required to check sensitivity, dial accuracy can be checked by the same instruments, provided the signal source has an accuracy within 0.1% at the dial check points. The signal generators listed in Table 6-9 may be used if their accuracy is checked near each dial check point, by a frequency counter or by the beat frequency indicator against some accurate reference frequency.



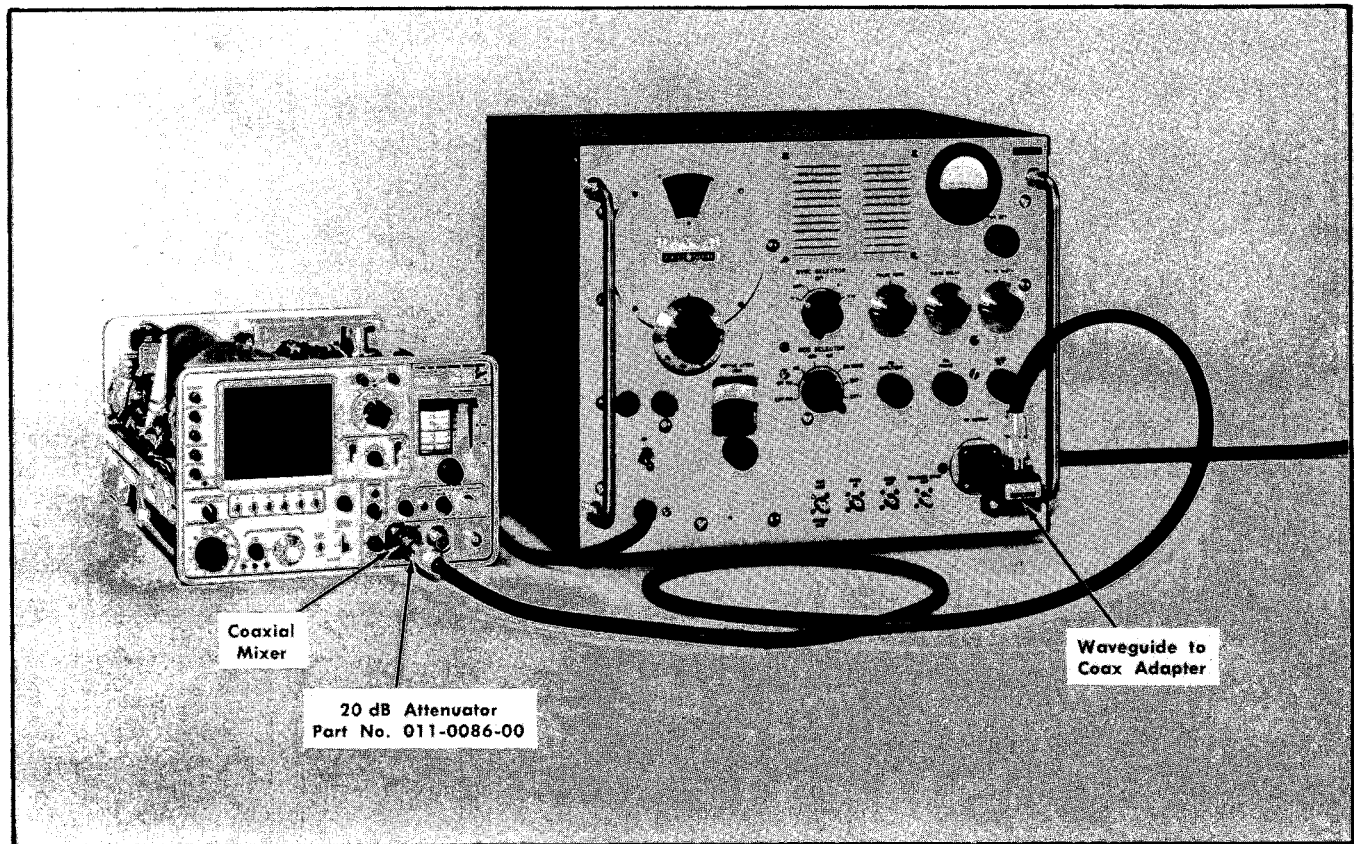

Fig. 6-42. Typical equipment setup to check response flatness, sensitivity, frequency calibration and phase lock operation for band C.

A secondary or alternate source of accurate frequency markers is the combination of two calibration fixtures (Harmonic Generator 067-0594-00 and a 200 MHz Trap 067-0595-00) and a relatively low frequency, accurate (at least 0.1%) signal source such as a Time-Mark Generator (Type 184).

The harmonic generator will produce sufficient harmonic signal power, from the Type 184, to produce frequency markers into the GHz range. The 200 MHz trap attenuates the IF feedthrough spurious response.

This procedure is divided into two steps, with step 38B describing the dial check procedure using the harmonic generator.

a. Equipment setups are shown in Fig. 6-41 through 6-43. Fig. 6-45 shows the setup for the alternate procedure to check dial accuracy (step 38 B),

b. Apply a frequency and amplitude calibrated signal, between -60 dBm and -30 dBm, to the appropriate RF INPUT connector. Switch the Type 491 band selector switch to the appropriate band.

c. Set the DISPERSION to 500 kHz/div and the RESOLUTION control for a resolution bandwidth of 100 kHz (fully clockwise).

d. Adjust the GAIN control for an average noise amplitude of one division. Center the IF CENTER FREQ and FINE RF CENTER FREQ controls.

e. Tune the signal on screen with the RF CENTER FREQUENCY control. Reduce the signal amplitude with the signal generator output attenuator control for an on-screen display, then adjust the MIXER PEAKING control and sweep rate for optimum signal amplitude. (Sweep rate 5 ms/div or slower.)

f. Calibrate the signal generator output, then adjust the variable output attenuator control on the signal generator until the signal amplitude is two divisions (twice the noise amplitude). See Fig. 6-44.

g. Check the total signal attenuation (in dB) below 0 dBm as indicated on the signal generator attenuator dial. This is the sensitivity of the analyzer for the RF center frequency indicated. Check as listed in Table 6-9 under 100 kHz resolution. Sensitivity can also be checked for 1 kHz resolution, however, a very stable signal source is required at the higher frequencies. Sweep speed must be reduced to 50 ms/div or slower to check sensitivity at 1 kHz resolution.



TABLE 6-9

Suggested Signal Generator (Refer to equipment list)	Frequency	Band	Sensitivity (Equal to or better than)		Dial Accuracy Check Frequency
			100 kHz	1 kHz	
Hewlett-Packard Model 608D	10 MHz	1	-80 dBm	-100 dBm	Every 10 MHz
	140 275				
Hewlett-Packard Model 612A	275	2	-90 dBm	-110 dBm	Every 100 MHz
	400				
Hewlett-Packard Model 8614A	900	3	-85 dBm	-105 dBm	Every 500 MHz
	850				
Hewlett-Packard Model 8616A	1.5 GHz	4 <sup>1</sup>	-90 dBm	-110 dBm	Every 1.0 GHz
	2.0				
Polarad Type 1107	1.5	5 <sup>1</sup>	-80 dBm	-100 dBm	
	2.5				
Polarad Type 1108	4.0	6 <sup>1</sup>	-75 dBm	-95 dBm	
	4.0				
Hewlett-Packard Model 626A	6.0	7 <sup>2</sup>	-70 dBm	-90 dBm	
	8.0				
Hewlett-Packard Model 628A	8.0	8 <sup>2</sup>	-60 dBm	-80 dBm	
	10.0				
Hewlett-Packard Model 938	12.0	8 <sup>2</sup>	-50 dBm	-70 dBm	
	12.4				
Hewlett-Packard Model 940	15.0				
	18.0				
Hewlett-Packard Model 940	18.0				
	25.0				
Hewlett-Packard Model 940	26.5				
	40.0				

<sup>1</sup>Sensitivity is specified at the mixer input. Insertion loss through the cable, at the higher (GHz) frequency range, will become significant. Fig. 645 is a graph that shows the approximate loss in dB for a 6 foot coaxial cable.

<sup>2</sup>When checking the sensitivity of scales 7 and 8, apply the source signal to the Waveguide Mixer, then connect the Waveguide Mixer to the Mixer Adapter-through the 2 foot cable with TNC connectors.

- 2) Center the FINE RF CENTER FREQ control. Depress the LOCK CHECK button and adjust the RF CENTER FREQ control until a beat frequency is displayed.
- 3) Adjust the FINE RF CENTER FREQ control for a lock condition or until the beat reduces to zero (zero beat).
- 4) Repeat the above procedure with a 5 MHz signal from the signal generator.
- 5) Increase the input signal amplitude to 5 V peak to peak and repeat the check with the increased signal amplitude at 5 MHz and 1 MHz.

**38B. Alternate Procedure to Check Dial Accuracy, Oscillator Mixer Operation and Effectiveness of Local Oscillator Phase Lock**

- a. Equipment setup is shown in Fig. 6-46.
- b. Apply 100 MHz (10 ns) markers from the marker output of the time-mark generator through the harmonic generator, the 200 MHz trap, and the 20 dB attenuator to the band B RF INPUT connector.
- c. Switch the band selector to B. Set the DISPERSION to 2 MHz/div and switch the VERTICAL DISPLAY selector to LOG.

- d. Check the dial accuracy as follows:
  - 1) Tune the RF CENTER FREQUENCY through the band. Observe the 100 MHz harmonics and their image spuri as they travel across the screen towards the center and merge with the IF feedthrough response, as the dial crosses a frequency check point. The harmonics then separate and move off the screen. See Fig. 6-47. Maximum error between the dial readings and frequency check points must not exceed  $\pm (2 \text{ MHz} + 1\% \text{ of the dial reading})$ .
  - 2) Adjust the MIXER PEAKING control to optimize signal amplitude. Note the spectral display of the harmonic generator signals. Tune the RF CENTER FREQUENCY through the band, checking for dead spots which could be caused by either local oscillator failure or mixer malfunction. The MIXER PEAKING must be peaked at all check points.
- e. Check-Local oscillator phase lock operation as follows:
  - 1) Turn the INT REF FREQ control on. Decrease the DISPERSION to 500 kHz/div.
  - 2) Depress the LOCK CHECK button and adjust the FINE RF CENTER FREQ control to position the display to the center of the graticule area. Release the LOCK CHECK button.
  - 3) Shift the IF feedthrough response approximately 2 divisions off center with the IF CENTER FREQ control, then

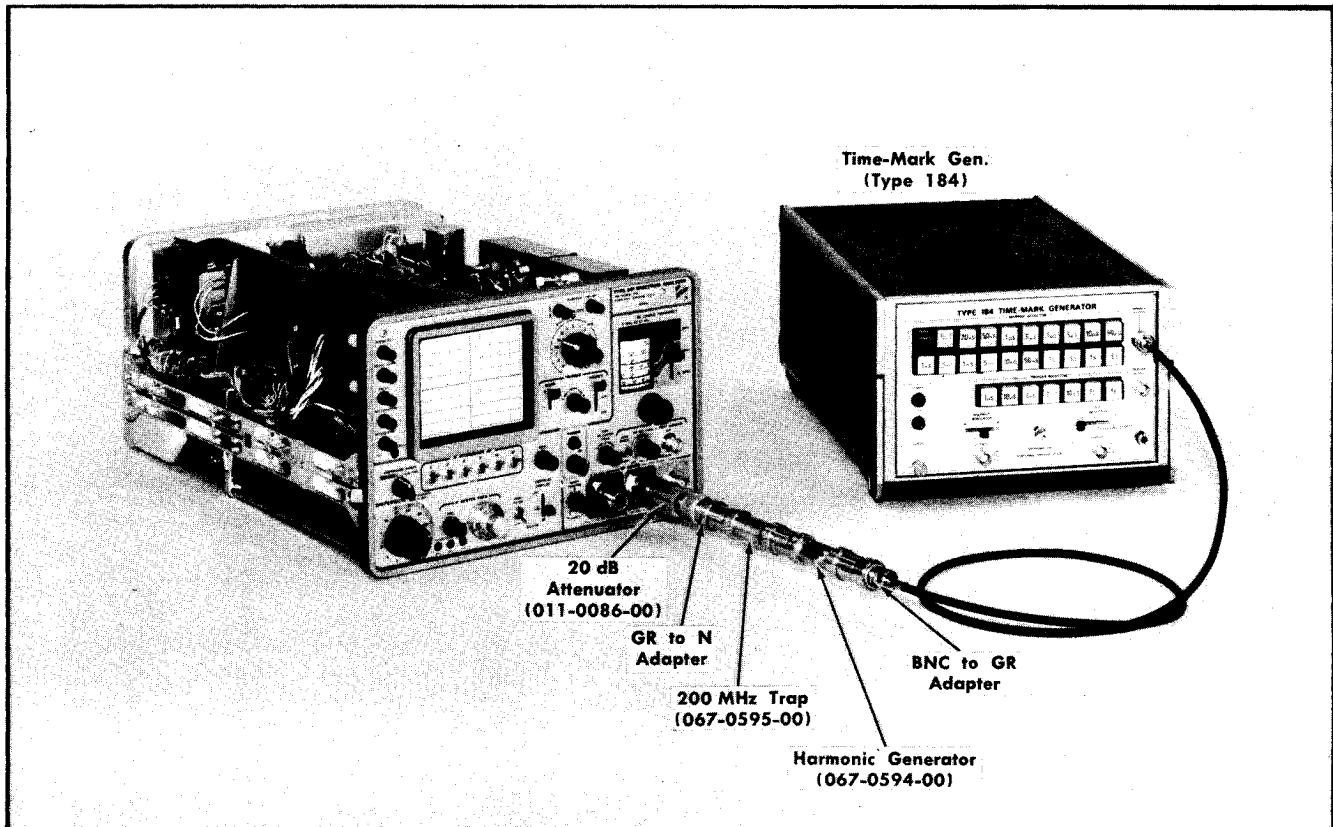

Fig. 6-45. Alternate equipment setup that will check dial accuracy, mixer and oscillator operation, and LO phase lock effectiveness.

### 38B. Alternate Procedure to Check Dial Accuracy, Oscillator Mixer Operation and Effectiveness of Local Oscillator Phase Lock

a. Equipment setup is shown in Fig. 6-45.

b. Apply 100 MHz (10 ns) markers from the marker output of the time-mark generator through the harmonic generator, the 200 MHz trap, and the 20 dB attenuator to the band B RF INPUT connector.

c. Switch the band selector to B. Set the DISPERSION to 2 MHz/div and switch the VERTICAL DISPLAY selector to LOG.

d. Check the dial accuracy as follows:

1) Tune the RF CENTER FREQUENCY through the band. Observe the 100 MHz harmonics and their image spurs as they travel across the screen towards the center and merge with the IF feedthrough response, as the dial crosses a frequency check point. The harmonics then separate and move off the screen. See Fig. 6-46. Maximum error between the dial readings and frequency check points must not exceed  $\pm (2 \text{ MHz} + 1\% \text{ of the dial reading})$ .

2) Adjust the MIXER PEAKING control to optimize signal amplitude. Note the spectral display of the harmonic genera-

tor signals. Tune the RF CENTER FREQUENCY through the band, checking for dead spots which could be caused by either local oscillator failure or mixer malfunction. The MIXER PEAKING must be peaked at all check points.

e. Check-Local oscillator phase lock operation as follows:

1) Turn the INT REF FREQ control on. Decrease the DISPERSION to 500 kHz/div.

2) Depress the LOCK CHECK button and adjust the FINE RF CENTER FREQ control to position the display to the center of the graticule area. Release the LOCK CHECK button.

3) Shift the IF feedthrough response approximately 2 divisions off center with the IF CENTER FREQ control, then tune the RF CENTER FREQ to any harmonic signal. Depress the LOCK CHECK button and adjust the FINE RF CENTER FREQ control to establish a lock mode on the harmonic signal. See Operating instructions.

4) Decrease the DISPERSION to 50 kHz/div, keeping the signal centered on screen with the IF CENTER FREQ control.

5) Slowly adjust the FINE RF CENTER FREQ control until the LO loses its lock. The signal may shift screen when the LO loses phase lock. Re-establish phase lock by adjusting the FINE RF CENTER FREQ control to return the signal on screen.

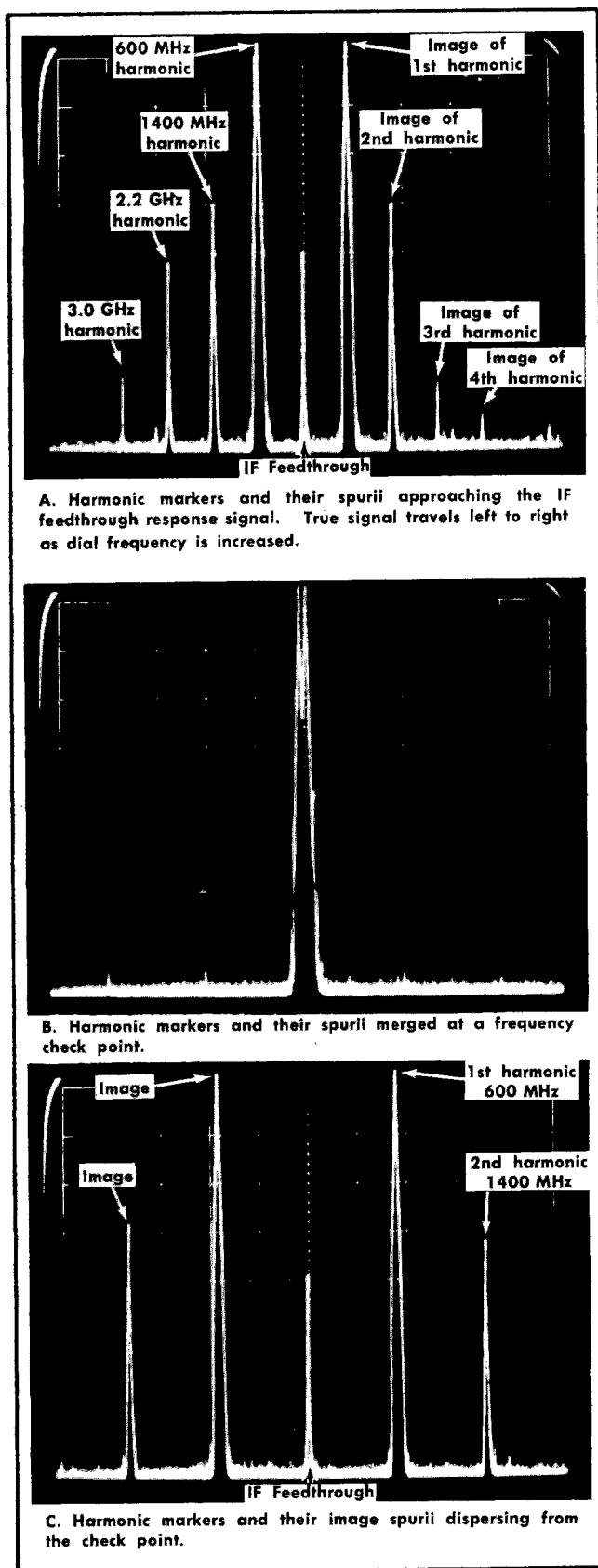

Fig. 6-47. Harmonic frequency markers used to check dial accuracy.

tune the RF CENTER FREQ to any harmonic signal. Depress the LOCK CHECK button and adjust the FINE RF CENTER FREQ control to establish a lock mode on the harmonic signal. See Operating instructions.

4) Decrease the DISPERSION to 50 kHz/div, keeping the signal centered on screen with the IF CENTER FREQ control,

5) Slowly adjust the FINE RF CENTER FREQ control until the LO loses its lock. The signal may shift screen when the LO loses phase lock. Re-establish phase lock by adjusting the FINE RF CENTER FREQ control to return the signal on screen,

6) Slowly adjust the INT REF FREQ VARIABLE control. Note the signal shift across the dispersion window as the reference oscillator frequency is changed. Range of the control is approximately 0.1% of the dial frequency. See step 27.

f. Remove the signal and harmonic source from band B RF INPUT connector and apply the signals to band C Co-axial Mixer. Switch the band selector to C and set the DISPERSION to 2 MHz/div.

g. Check dial accuracy over scale 4, band C. Check oscillator and mixer operation and local oscillator phase lock as the dial accuracy is checked. Check these parameters by repeating the procedure described in step d for band B.

#### NOTE

There is no need to check dial calibration for the upper scales of band C because they are multiples of scale 4.

h. Apply 10 MHz (.1  $\mu$ s) marker signals and harmonics to the band A RF INPUT. Switch the band selector to A. Set the DISPERSION to 1 MHz/div.

i. Check the dial accuracy, oscillator and mixer performance, and LO phase lock operation through band A. Check by using the same procedure that was used to check bands B and C.

j. Check phase lock operation with an external reference frequency. Use the procedure described in step 38A (k).

## RF AND LOCAL OSCILLATOR CALIBRATION

#### NOTE

The following procedures are NOT part of the routine calibration. They only provide a means of calibrating the RF section after minor repair, such as oscillator tube replacement. If possible we recommend the complete RF assembly or the complete unit be returned to Tektronix for repair. See your local Tektronix Field Office or representative.

#### Dial Tracking

1. Apply power to the oscillator and allow 20 minutes warmup time for the oscillator to stabilize.

2. Push the LOCK CHECK button and adjust the RF FINE FREQ control for a centered (vertical) trace. This should provide a varactor bias reading of +7.0 volts. See Fig. 6-48.

3. Use an accurate frequency meter or counter to tune the A band oscillator to exactly 375.5 MHz (200 MHz above a dial reading of 175.5).

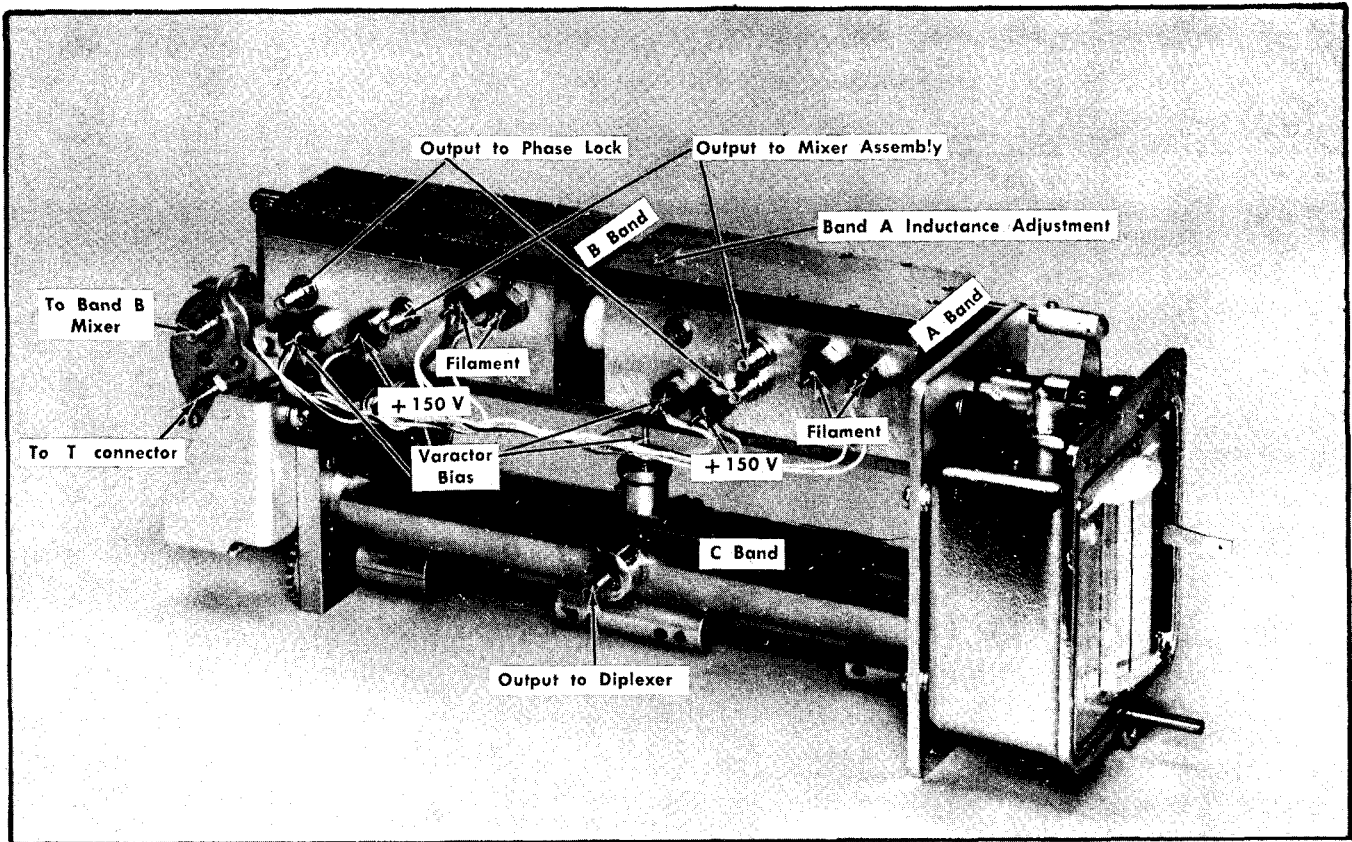

Fig. 6-47. Local oscillator assembly showing Voltage and signal connections.

6. Tune the band B oscillator to exactly 835 MHz. The dial tape should read  $635 \pm 8$  MHz on scale 2. If the tape does not read within this range, the coupling between the two oscillators must be reset. Adjust the coupling as follows:

- a. Loosen the two set screws through the flexible coupling to the band B (rear) oscillator drive shaft.
- b. Set the tape to read exactly 635.
- c. Hold the front shaft at 635 on the dial and manually tune the band B (rear) oscillator to 835 MHz.
- d. Tighten the set screws.

7. Check the dial tape tracking on band B at several points, including each end of the band. The oscillator frequency must track within  $\pm 1\%$  of the dial frequency  $\pm 200$  MHz.

## BAND A LOCAL OSCILLATOR CALIBRATION PROCEDURE

### NOTE

This procedure is to be used only after replacing V40 (the Band A local oscillator tube) or performing some other internal repair on the Band A local oscillator. This procedure requires that the band B local oscillator be operating and tracking to the dial tape.

1. Perform the necessary repairs. Replace all covers. All screws must be tight.
2. Switch the band selector switch to B.
3. Push the LOCK CHECK button and adjust the Type 491 FINE RF CENTER FREQ control for a centered trace or  $\pm 7.0$

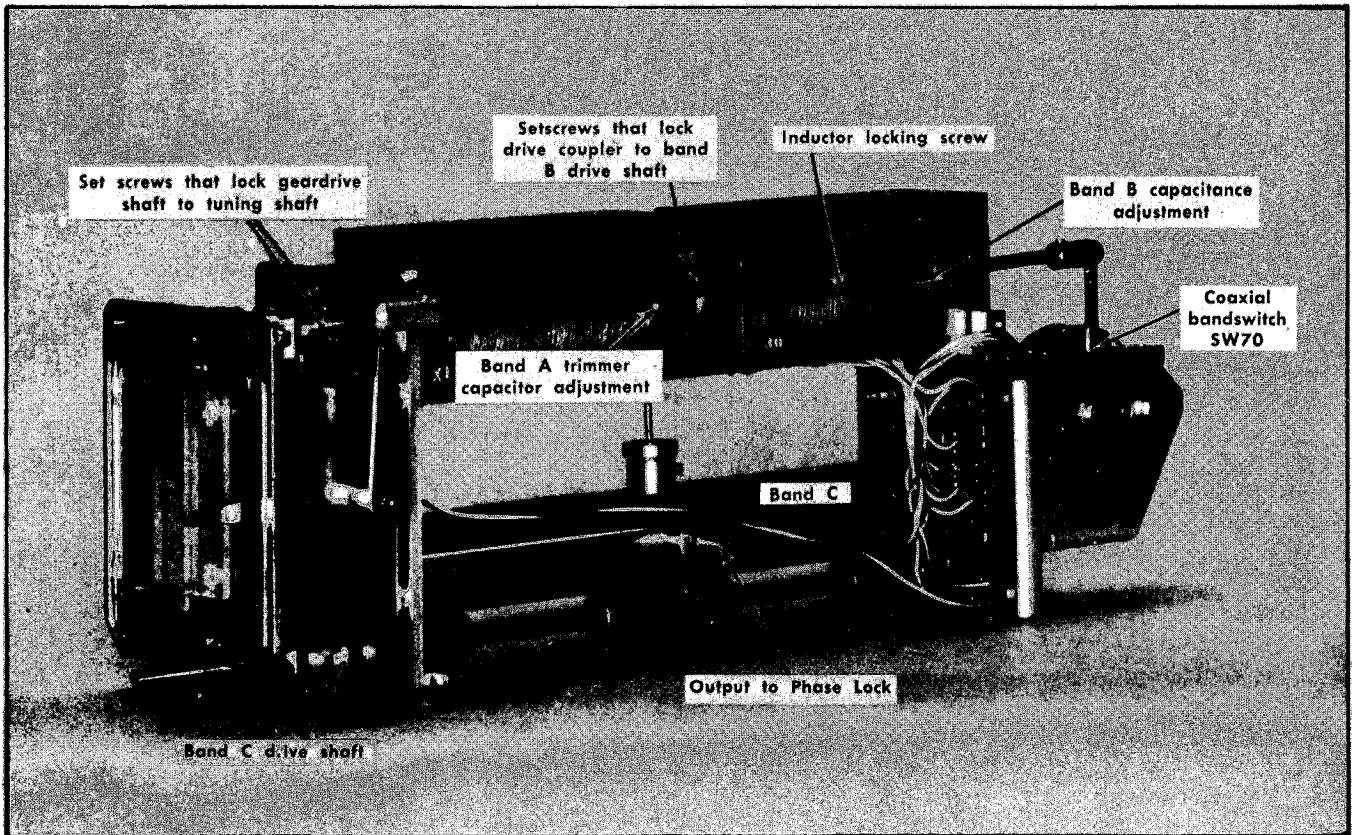

Fig. 6-49. Local oscillator assembly showing drive shaft coupling and tuning adjustments.

volts at the varactor bias terminal for the band B oscillator. See Fig. 6-48.

4. Use an accurate frequency meter to check the oscillator frequency and tune the band B local oscillator to 835 MHz. (Oscillator frequency can be checked by disconnecting the Sealectro Connector J69 at the mixer output and connecting the oscillator output through an adapter cable to the frequency meter.)

5. Check the dial reading for 635 MHz on scale 2. If dial is incorrect, loosen the set screws holding the coupling between the drive shaft and the tuning shaft (see Fig. 6-48). Tune the dial to read 635. This sets the dial tape to a known frequency point on the tuning curve for both oscillators.

6. Check the dial tape tracking of the B band at several points, including each end of the band. The oscillator frequency must be within  $\pm$  (1% of the dial tape frequency plus 200 MHz).

7. Switch the band selector to A.

8. Push the LOCK CHECK button and adjust the FINE RF CENTER FREQ control for a centered trace or +7.0 V at the varactor bias terminal on band A local oscillator. See Fig. 6-48.

9. Set the frequency meter to 210 MHz. Tune the dial to 10 MHz and adjust the A band inductance adjustment (Fig. 6-49) to tune the oscillator frequency to 210 MHz.

10. Set the frequency meter to 475 MHz. Tune the dial tape to 275 and adjust the A band capacitance adjustment (Fig. 6-49) to tune the oscillator frequency to 475 MHz.

11. Repeat steps 9 and 10 until both frequency check points match the dial tape reading.

12. Set the frequency meter to indicate 375.5 MHz. Tune the oscillator to 375.5 MHz. The frequency dial tape must read between 174 and 177. If the tape does not read within this range, both oscillators require special equipment to calibrate and should be returned to Tektronix for repair and calibration.

## BAND B LOCAL OSCILLATOR

### Calibration Procedure

This procedure requires that the band A local oscillator be operating and tracking correctly. Both band A and B covers must be in place and all screws must be tight.

1. Set the band selector to band B. Push the LOCK CHECK button and adjust the RF FINE FREQ control for a centered display, or a varactor bias reading of 7.0 volts for band B oscillator.

2. By means of a frequency meter or frequency counter, set band B oscillator to 470 MHz. Note which side of 270 on scale 2 the dial indicates.

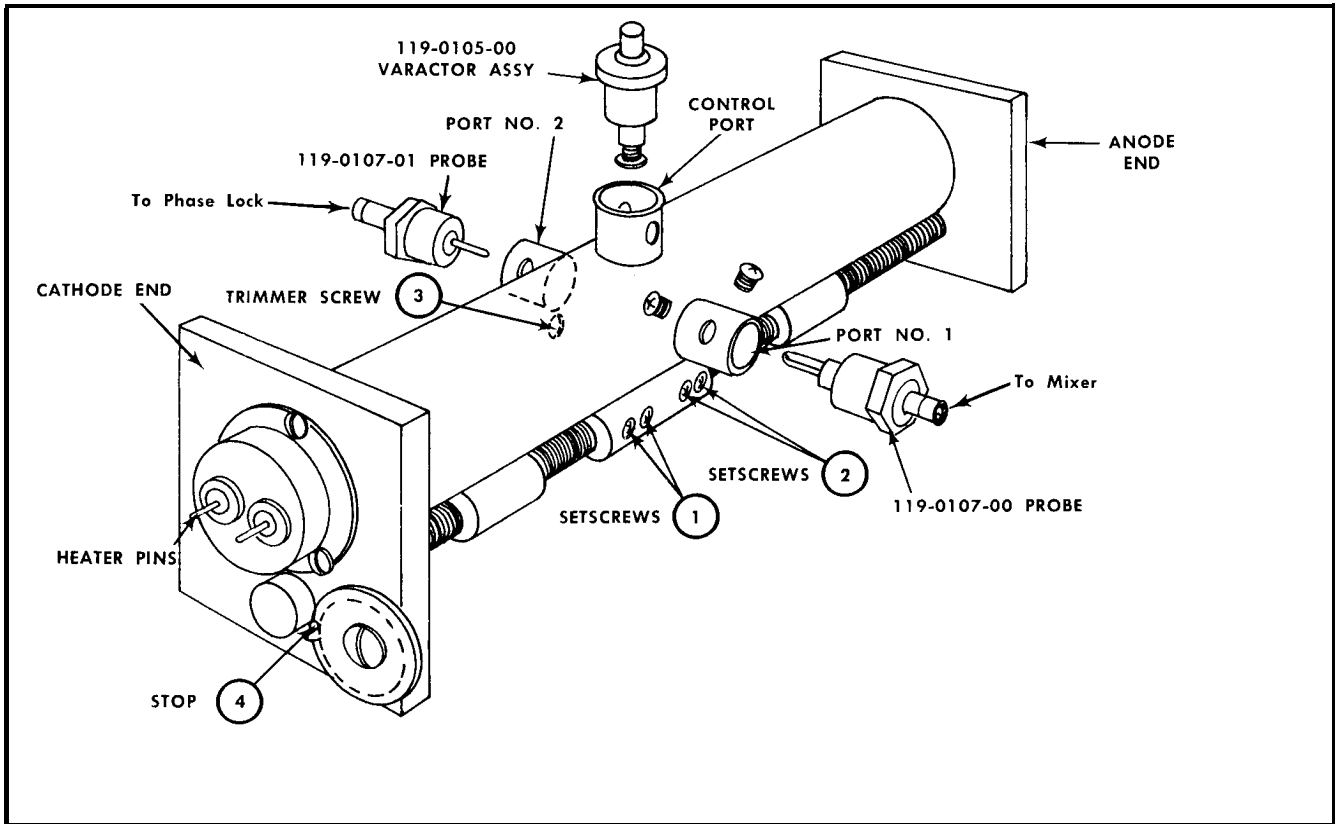

Fig. 6-49. Band C Assembly Alignment Diagram.

3. Turn the POWER switch to OFF. Loosen the inductor lock screw on the left side of the oscillator chamber (see Fig. 6-48). This screw is on the left side slightly forward of the center point. Do not confuse this adjustment with the high frequency capacitor adjustment located between the two spring-like wires protruding from the side wall.

4. If the dial reading in step 2 was above 270, more inductance is required. Turn the inductor adjustment counter-clockwise. If the dial reading was below 270, turn the adjustment clockwise. Turn the adjustment approximately one turn at a time then recheck.

5. Remove the screwdriver from the access hole, turn the POWER switch ON and return the oscillator frequency to 470 MHz.

6. Again check the dial reading. If necessary again turn off the POWER switch and repeat step 4 until the dial reads 270 when the oscillator frequency is 470 MHz.

7. Set the frequency meter to 1100 MHz and tune the dial to 900.

8. Adjust the band B capacitance adjustment (see Fig. 6-48) to tune the oscillator frequency to 1100 MHz.

9. Repeat the inductance adjustment and capacitance adjustment until the dial tracks at the low and high end of the scale, then tighten the inductor locking screw.

10. Set the frequency meter to 835 MHz and tune the local oscillator to this frequency. Check the dial reading. Must read between 630 and 640 MHz.

If the dial does not read within this range, both oscillators require repair and adjustment using special equipment. The assembly should be returned to Tektronix for repair and calibration. See your local Tektronix Field Office or representative.

## BAND C OSCILLATOR CALIBRATION

### NOTE

This procedure should only be required after the oscillator tube has been replaced. The oscillator assembly must be removed from the instrument for calibration. See Maintenance section.

Calibration of this oscillator is very critical and should only be attempted by qualified personnel with adequate facilities. The complete oscillator assembly is listed in the Mechanical Parts list. We recommend replacing the complete assembly and returning the defective assembly to your Tektronix Field office or representative.

Refer to Fig. 6-49 for the location of the sub-assemblies and parts. The oscillator assembly must be removed for



calibration. See Maintenance Section. The probe assemblies can be oriented within the magnetic field of the oscillator chamber by loosening set screws and positioning the probe in or out of the chamber or rotating the probe within the field.

Usually the probes are rotated for maximum power output and inserted in or out of the chamber for the specified power output. It is important to keep the output power below the maximum specification listed in steps 1 (m) and 1 (o) of the following procedure. All adjustments interact; therefore, as each adjustment is made, its effect on the frequency tracking and output power over the frequency range of the oscillator must be checked. Adjust to obtain as flat an output as possible with frequency tracking within  $\pm 1\%$ .

## ALIGNMENT PROCEDURE FOR BAND C OSCILLATOR ASSEMBLY

This procedure should be used only after replacing the oscillator tube. Refer to Fig. 6-50 for the location of sub-assemblies and parts. The oscillator assembly must be removed for calibration.

### 1. Alignment and Installation of the Probe and Varactor Assemblies.

a. Install probe assembly (Part No. 119-0107-01 into the No. 2 port Fig. 6-50). Position the probe assembly approximately  $\frac{1}{16}$  inch out from full penetration with the notch or keyway (DC return of the probe towards the plate end of the oscillator assembly, and secure by tightening one of the two set screws.

#### CAUTION

Do not over-tighten set screws. They may warp the shaft if tightened too much.

b. Install probe assembly (Part No. 119-0107-00) into the No. 1 port (Fig. 6-50). Position the probe assembly approximately  $\frac{1}{16}$  inch out from full penetration with the notch or keyway towards the plate end of the oscillator assembly, and secure by tightening one of the two set screws.

c. Install the Varactor assembly (Part No. 119-01 05-00) into the control port. Position the assembly approximately  $\frac{1}{16}$  inch out from full penetration and secure by tightening one of the two set screws.

d. Position the cathode and plate chokes to the high frequency end of the band (towards the center of the assembly) but not against the stop.

e. Connect an RF power meter through a 50  $\Omega$ , 10 dB attenuator and a 9 inch coaxial cable (clear cable covering) to the No. 2 port.

f. Connect a frequency counter or accurate frequency measuring device through a 50  $\Omega$  termination and a 9 inch lossy coaxial cable (white cable covering) to the No. 1 port.

g. Apply power (B+ and filament supply) to the oscillator. Allow approximately 10 minutes for the oscillator to stabilize.

h. Loosen the set screw to No. 2 port and rotate probe assembly for maximum power input. Do not rotate the probe 180° from the preset position. If power output exceed

100 mW, decrease the coupling by pulling the probe assembly out. Tighten the set screws.

i. Loosen the set screws (1) in Fig. 6-50, and position the plate choke for a frequency of 4.2 GHz.

Force the lead screw against the bearing and tighten the set screws.

j. Loosen the set screws (2) in Fig. 6-50, and position the cathode choke for maximum power output. Decrease probe coupling if power output exceeds 100 mW.

Force the lead screws against the bearing and tighten the set screws.

k. Connect the Varactor terminal to a +1.5 V to +14 V bias supply. The instrument bias supply is preferred. Set the Varactor bias voltage to +7 V and tune the oscillator to its mid-frequency position.

l. Vary the position of the Varactor assembly, until a bias swing from +1.5 V to +14 V provides a frequency shift equal to or greater than 1.5 MHz. Return the bias voltage to +7 V, by adjusting the FINE RF CENTER FREQ control.

m. Tune the oscillator through its frequency range checking the output power. Power output over the range should not exceed 100 mW or decrease below 5 mW.

n. Remove the RF power meter from the No. 2 port and connect the meter through a 50  $\Omega$  10 dB attenuator and 9 inch lossy cable to the No. 1 port. Connect the 9 inch (not lossy) coaxial cable from the instrument-phase lock circuit to the No. 2 port.

o. Tune the oscillator through its frequency range checking the output power from the No. 1 port. Power output should not exceed 16 mW or decrease below 2 mW.

Balancing the output of ports No. 1 and No. 2 may be necessary to provide the desired output from both ports. This is done by loosening the 2-56 set screw in the probe assembly and varying the coupling. Each adjustment interacts with the other adjustments, therefore, both outputs must be checked after each adjustment.

### 2. Tracking the oscillator to the dial assembly.

a. Tune the oscillator to 4.2 GHz. Set the indicated dial assembly to 4.0 GHz and lock the dial assembly to the oscillator tuning shaft.

b. Tune the dial to indicate 1.5 GHz. Adjust the trimmer screw (3) in Fig. 6-50, for an oscillator frequency of 1.7 GHz.

c. Repeat these steps until the oscillator frequency corresponds to the dial reading at both ends of the frequency band.

d. Check oscillator tracking through the frequency range. Must track within  $\pm 1\%$  of the indicated dial reading (+200 MHz). It may be necessary to introduce some error at the upper or lower frequency limits to bring the tracking within the  $\pm 1\%$  specification.



e. Check the phase lock operation over the frequency range. Check for the presence of beat frequency signals and stable locking operation.



## PARTS LIST ABBREVIATIONS

BHB	binding head brass	int	internal
BHS	binding head steel	lg	length or long
cap.	capacitor	met.	metal
cer	ceramic	mtg hdw	mounting hardware
comp	composition	OD	outside diameter
conn	connector	OHB	oval head brass
CRT	cathode-ray tube	OHS	oval head steel
csk	countersunk	PHB	pan head brass
DE	double end	PHS	pan head steel
dia	diameter	plstc	plastic
div	division	PMC	paper, metal cased
elect.	electrolytic	poly	polystyrene
EMC	electrolytic, metal cased	prec	precision
EMT	electrolytic, metal tubular	PT	paper, tubular
ext	external	PTM	paper or plastic, tubular, molded
F & I	focus and intensity	RHB	round head brass
FHB	flat head brass	RHS	round head steel
FHS	flat head steel	SE	single end
Fil HB	fillister head brass	SN or S/N	serial number
Fil HS	fillister head steel	Sw	switch
h	height or high	TC	temperature compensated
hex.	hexagonal	THB	truss head brass
HHB	hex head brass	thk	thick
HHS	hex head steel	THS	truss head steel
HSB	hex socket brass	tub.	tubular
HSS	hex socket steel	var	variable
ID	inside diameter	w	wide or width
incd	incandescent	WW	wire-wound

### SPECIAL NOTES AND SYMBOLS

- × 0 0 0 Part first added at this serial number
- 0 0 × Part removed after this serial number
- \*000-0000-00 Asterisk preceding Tektronix Part Number indicates manufactured by or for Tektronix, Inc., or reworked or checked components.
- Use 000-0000-00 Part number indicated is direct replacement
-  Screwdriver adjustment.
-  Control, adjustment or connector.

# SECTION 7

## ELECTRICAL PARTS LIST

Values are fixed unless marked Variable.

Ckt. No.	Tektronix Part No.	Serial/Model No. Eff	Disc	Description			
<b>Bulbs</b>							
B901	150-0045-00			Incandescent #685			
B942	150-0059-00			Incandescent #386			
B943	150-0059-00			Incandescent #386			
<b>Capacitors</b>							
Tolerance $\pm 20\%$ unless otherwise indicated.							
C10	283-0067-00	B010100	B119999	0.001 $\mu$ F	Cer	200 V	10%
C10	283-0121-00	B120000		0.001 $\mu$ F	Cer	200 V	
C14	281-0105-00			0.8-8.5 pF, Var	Cer		
C16	281-0105-00			0.8-8.5 pF, Var	Cer		
C17	281-0518-00	B010100	B119999	47 pF	Cer	500 V	
C17	281-0651-00	B120000		47 pF	Cer		5%
C23	281-0613-00			10 pF	Cer	200 V	10%
C24	281-0105-00			0.8-8.5 pF, Var	Cer		
C26	281-0613-00			10 pF	Cer	200 V	10%
C27	281-0105-00			0.8-8.5 pF, Var	Cer		
C29	281-0613-00			10 pF	Cer	200 V	10%
C30	281-0105-00			0.8-8.5 pF, Var	Cer		
C32	281-0613-00			10 pF	Cer	200 V	10%
C34	281-0105-00			0.8-8.5 pF, Var	Cer		
C51	283-0067-00			0.001 $\mu$ F	Cer	200 V	10%
C64 <sup>1</sup>							
C66 <sup>1</sup>							
C68 <sup>1</sup>							
C69 <sup>1</sup>							
C83	281-0616-00			6.8 pF	Cer	200 V	
C84	281-0105-00			0.8-8.5 pF, Var	Cer		
C86	281-0616-00			6.8 pF	Cer	200 V	
C87	281-0105-00			0.8-8.5 pF, Var	Cer		
C89	281-0616-00			6.8 pF	Cer	200 V	
C90	281-0105-00			0.8-8.5 pF, Var	Cer		
C92	281-0616-00			6.8 pF	Cer	200 V	
C94	281-0105-00			0.8-8.5 pF, Var	Cer		
C101	281-0101-00			1.5-9.1 pF, Var	Air		
C102	281-0099-00			1.3-5.4 pF, Var	Air		
C104	281-0101-00			1.5-9.1 pF, Var	Air		
C105	281-0648-00			56 pF	Cer		5%
C106	281-0101-00			1.5-9.1 pF, Var	Air		
C107	281-0099-00			1.3-5.4 pF, Var	Air		
C108	281-0101-00			1.5-9.1 pF, Var	Air		
C123	281-0635-00			1000 pF	Cer	500 V	
C124	281-0523-00	B010100	B039999	100 pF	Cer	350 V	
C124	283-0599-00	B040000		98 pF	Mica	500 V	5%

<sup>1</sup>Furnished as a unit with Mixer \*(119-0064-00)

### Capacitors (cont)

Ckt. No.	Tektronix Part No.	Serial/Model No. Eff      Disc	Description
C128	283-0065-01		0.001 $\mu$ F      Cer      100 V      5%
C130	283-0103-00		180 $\mu$ F      Cer      500 V      5%
C132	283-0039-00		0.001 $\mu$ F      Cer      500 V
C133	281-0635-00		1000 pF      Cer      500 V
C136	281-0616-00	XB040000	6.8 pF      Cer      200 V
C137	281-0063-00		9-35 pF, Var      Cer
C138	281-0635-00		1000 pF      Cer      500 V
C139	283-0039-00		0.001 $\mu$ F      Cer      500 V
C140	283-0103-00		180 $\mu$ F      Cer      500 V      5%
C143	281-0635-00		1000 pF      Cer      500 V
C145	281-0558-00		18 pF      Cer      500 V
C146	281-0549-00		68 pF      Cer      500 V      10%
C147	281-0523-00		100 pF      Cer      350 V
C148	283-0065-01		0.001 $\mu$ F      Cer      100 V      5%
C149	281-0635-00		1000 pF      Cer      500 V
C151	281-0549-00		68 pF      Cer      500 V      10%
C152	281-0549-00		68 pF      Cer      500 V      10%
C187	281-0549-00		68 pF      Cer      500 V      10%
C188	281-0549-00		68 pF      Cer      500 V      10%
C225	283-0003-00		0.01 $\mu$ F      Cer      150 V
C229	285-0703-00		0.1 $\mu$ F      PTM      100 V      5%
C233	283-0003-00		0.01 $\mu$ F      Cer      150 V
C236	283-0003-00		0.01 $\mu$ F      Cer      150 V
C237	283-0003-00		0.01 $\mu$ F      Cer      150 V
C250	283-0067-00		0.001 $\mu$ F      Cer      200 V      10%
C254	283-0003-00		0.01 $\mu$ F      Cer      150 V
C258	283-0003-00		0.01 $\mu$ F      Cer      150 V
C270	290-0167-00		10 $\mu$ F      Elect.      15 V
C293	283-0010-00		0.05 $\mu$ F      Cer      50 V
C300	283-0039-00		0.001 $\mu$ F      Cer      500 V
C310	283-0065-00		0.001 $\mu$ F      Cer      100 V      5%
C311	281-0613-00		10 pF      Cer      200 V      10%
C314	283-0563-00		1000 pF      Mica      500 V      10%
C315	281-0610-00		2.2 pF      Cer      200 V
C320	283-0039-00		0.001 $\mu$ F      Cer      500 V
C330	283-0003-00		0.01 $\mu$ F      Cer      150 V
C331	283-0003-00		0.01 $\mu$ F      Cer      150 V
C346	283-0050-00		0.008 $\mu$ F      Cer      200 V
C347	283-0050-00		0.008 $\mu$ F      Cer      200 V
C349	281-0503-00		8 pF      Cer      500 V $\pm 0.5$ pF
C357	283-0050-00		0.008 $\mu$ F      Cer      200 V
C358	281-0105-00		0.8-8.5 pF, Var      Cer
C361	283-0039-00		0.001 $\mu$ F      Cer      500 V
C362	281-0635-00		1000 pF      Cer      500 V
C363	283-0039-00		0.001 $\mu$ F      Cer      500 V

Capacitors (cont)

Ckt. No.	Tektronix Part No.	Serial/Model No. Eff Disc	Description
C365	283-0025-00	0.0005 $\mu$ F	Cer 500 V 5%
C367	283-0039-00	0.001 $\mu$ F	Cer 500 V
C368	283-0003-00	0.01 $\mu$ F	Cer 150 V
C373	283-0039-00	0.001 $\mu$ F	Cer 500 V
C376	283-0039-00	0.001 $\mu$ F	Cer 500 V
C383	283-0039-00	0.001 $\mu$ F	Cer 500 V
C384	281-0105-00	0.8-8.5 pF, Var	Cer
C385	281-0105-00	0.8-8.5 pF, Var	Cer
C386	283-0039-00	0.001 $\mu$ F	Cer 500 V
C401	283-0065-01	0.001 $\mu$ F	Cer 100 V 5%
C412	283-0003-00	0.01 $\mu$ F	Cer 100 V
C413	283-0039-00	0.001 $\mu$ F	Cer 500 V
C416	283-0001-00	0.005 $\mu$ F	Cer 500 V
C422	281-0599-00	1 pF	Cer 200 V
C423	283-0065-01	0.001 $\mu$ F	Cer 100 V 5%
C424	281-0564-00	24 pF	Cer 500 V 5%
C425	281-0105-00	0.8-8.5 pF, Var	Cer
C426	283-0065-01	0.001 $\mu$ F	Cer 100 V 5%
C427	283-0065-01	0.001 $\mu$ F	Cer 100 V 5%
C433	283-0065-01	0.001 $\mu$ F	Cer 100 V 5%
C434	281-0645-00	8.2 pF	Cer 500 V $\pm 0.25$ pF
C435	281-0105-00	0.8-8.5 pF, Var	Cer
C436	283-0065-01	0.001 $\mu$ F	Cer 100 V 5%
C437	283-0001-00	0.005 $\mu$ F	Cer 500 V
C443	283-0001-00	0.005 $\mu$ F	Cer 500 V
C445	281-0564-00	24 pF	Cer 500 V 5%
C446	281-0579-00	21 pF	Cer 500 V 5%
C447	281-0550-00	120 pF	Cer 500 V 10%
C450	281-0511-00	22 pF	Cer 500 V 10%
C453	283-0001-00	0.005 $\mu$ F	Cer 500 V
C454	283-0566-00	100 pF	Mica 500 V 5%
C456	283-0001-00	0.005 $\mu$ F	Cer 500 V
C457	283-0001-00	0.005 $\mu$ F	Cer 500 V
C462	283-0039-00	0.001 $\mu$ F	Cer 500 V
C463	283-0001-00	0.005 $\mu$ F	Cer 500 V
C464	283-0566-00	100 pF	Mica 500 V 5%
C466	283-0001-00	0.005 $\mu$ F	Cer 500 V
C467	283-0001-00	0.005 $\mu$ F	Cer 500 V
C469	283-0039-00	0.001 $\mu$ F	Cer 500 V
C501	281-0523-00	100 pF	Cer 350 V
C502	281-0523-00	100 pF	Cer 350 V
C504	281-0105-00	0.8-8.5 pF, Var	Cer
C508	281-0105-00	0.8-8.5 pF, Var	Cer
C515	283-0065-01	0.001 $\mu$ F	Cer 100 V 5%
C524	283-0039-00	0.001 $\mu$ F	Cer 500 V

**Capacitors (cont)**

Ckt. No.	Tektronix Part No.	Serial/Model No. Eff	Disc	Description		
C525	283-0039-00			0.001 $\mu$ F	Cer	500 V
C527	283-0003-00			0.01 $\mu$ F	Cer	150 V
C530	283-0003-00			0.01 $\mu$ F	Cer	150 V
C534	283-0003-00			0.01 $\mu$ F	Cer	150 V
C537	283-0003-00			0.01 $\mu$ F	Cer	150 V
C539	283-0003-00			0.01 $\mu$ F	Cer	150 V
C600	281-0629-00			33 pF	Cer	600 V 5%
C601	281-0118-00			8-90 pF, Var	Mica	
C602	283-0605-00			678 pF	Mica	300 V 1%
C603	281-0628-00			15 pF	Cer	600 V 5%
C604	281-0118-00			8-90 pF, Var	Mica	
C605	283-0605-00			678 pF	Mica	300 V 1%
C606	281-0628-00			15 pF	Cer	600 V 5%
C607	281-0118-00			8-90 pF, Var	Mica	
	283-0605-00			678 pF	Mica	300 V 1%
C609	281-0628-00			15 pF	Cer	600 V 5%
C610	281-0118-00			8-90 pF, Var	Mica	
C611	283-0605-00			678 pF	Mica	300 V 1%
C612	281-0629-00			33 pF	Cer	600 V 5%
C622	283-0003-00			0.01 $\mu$ F	Cer	150 V
C625	283-0067-00			0.001 $\mu$ F	Cer	200 V 10%
C627	283-0067-00			0.001 $\mu$ F	Cer	200 V 10%
C630	283-0003-00			0.01 $\mu$ F	Cer	150 V
C632	283-0003-00			0.01 $\mu$ F	Cer	150 V
C633	283-0003-00			0.01 $\mu$ F	Cer	150 V
C635	283-0003-00			0.01 $\mu$ F	Cer	150 V
C641	281-0629-00			33 pF	Cer	600 V 5%
C642	281-0629-00			33 pF	Cer	600 V 5%
C647	283-0003-00			0.01 $\mu$ F	Cer	150 V
C651	281-0518-00			47 pF	Cer	500 V
C655	283-0081-00			0.1 $\mu$ F	Cer	25 V +80%—20%
C664	283-0003-00	XB130000		0.01 $\mu$ F	Cer	150 V
C666	283-0079-00			0.01 $\mu$ F	Cer	250 V
C670	281-0627-00			1 pF	Cer	600 V
C680	283-0027-00			0.02 $\mu$ F	Cer	50 V
C681	283-0027-00			0.02 $\mu$ F	Cer	50 V
C684	281-0541-00			6.8 pF	Cer	500 V 10%
C692	283-0079-00			0.01 $\mu$ F	Cer	250 V
C696	283-0079-00			0.01 $\mu$ F	Cer	250 V
C701	*285-0736-00			0.1 $\mu$ F	MT	60 V +5%—15%
C703	283-0079-00			0.01 $\mu$ F	Cer	250 V
C709	283-0027-00			0.02 $\mu$ F	Cer	50 V
C712	283-0027-00			0.02 $\mu$ F	Cer	50 V
C717	283-0027-00			0.02 $\mu$ F	Cer	50 V
C722	283-0027-00			0.02 $\mu$ F	Cer	50 V
C732	283-0027-00			0.02 $\mu$ F	Cer	50 V



Capacitors (cont)

Ckt. No.	Tektronix Part No.	Serial/Model No. Eff	Disc	Description		
C739	283-0079-00			0.01 $\mu$ F	Cer	250 V
C741	281-0536-00			1000 pF	Cer	500 V 10%
C753	283-0027-00			0.02 $\mu$ F	Cer	50 V
C755	281-0575-00			39 pF	Cer	500 V 1%
C761	283-0078-00			0.001 $\mu$ F	Cer	500 V
C785A )	*295-0103-00			10 $\mu$ F		Timing Series
C785B )				1 $\mu$ F		
C785C )				0.1 $\mu$ F		
C785D )				0.01 $\mu$ F		
C785E )				0.001 $\mu$ F		
C794	283-0079-00			0.01 $\mu$ F	Cer	250 V
C797	281-0501-00			4.7 pF	Cer	500 V $\pm 1$ pF
C802	283-0079-00			0.01 $\mu$ F	Cer	250 V
C825	283-0078-00			0.001 $\mu$ F	Cer	500 V
C833	283-0079-00			0.01 $\mu$ F	Cer	250 V
C902	283-0006-00			0.02 $\mu$ F	Cer	500 V
C903	283-0057-00			0.1 $\mu$ F	Cer	200 V +80% -20%
C904A,B,C	290-0306-00			100 x 20 x 20 $\mu$ F	Elect.	250 V/200 V/25 V
C906	283-0078-00			0.001 $\mu$ F	Cer	500 V
C910	283-0078-00			0.001 $\mu$ F	Cer	500 V
C913	281-0523-00	B010100	B059999	100 pF	Cer	350 V
C913	281-0536-00	B060000		1000 pF	Cer	500 V 10%
C922	283-0004-00			0.02 $\mu$ F	Cer	150 V
C924	290-0174-00			4500 $\mu$ F	Elect.	25 V +100% -10%
C925	290-0167-00			10 $\mu$ F	Elect.	15 V
C930	281-0511-00			22 pF	Cer	500 V 10%
C952	283-0004-00			0.02 $\mu$ F	Cer	150 V
C954	290-0279-00			1000 $\mu$ F	Elect.	25 V
C958	283-0079-00			0.01 $\mu$ F	Cer	250 V
C964	290-0107-00			25 $\mu$ F	Elect.	25 V
C968	290-0248-01			150 $\mu$ F	Elect.	15 V
C972	283-0092-00			0.03 $\mu$ F	Cer	200 V +80% -20%
C974	283-0059-00			1 $\mu$ F	Cer	25 V +80% -20%
C976	283-0059-00			1 $\mu$ F	Cer	25 V +80% -20%
C982	283-0079-00			0.01 $\mu$ F	Cer	250 V
C984	283-0027-00			0.02 $\mu$ F	Cer	50 V
C990	283-0079-00			0.01 $\mu$ F	Cer	250 V
C992	283-0027-00			0.02 $\mu$ F	Cer	50 V
C998	283-0059-00			1 $\mu$ F	Cer	25 V +80% -20%
C1001	283-0081-00			0.1 $\mu$ F	Cer	25 V +80% -20%
C1009	283-0081-00			0.1 $\mu$ F	Cer	25 V +80% -20%
C1010	285-0703-00			0.1 $\mu$ F	PTM	100 V 5%
C1011	283-0008-00			0.1 $\mu$ F	Cer	500 V
C1012	285-0572-00			0.1 $\mu$ F	PTM	200 V
C1014	283-0120-00			0.015 $\mu$ F	Cer	2500 V +80% -30%
C1016	283-0120-00			0.015 $\mu$ F	Cer	2500 V +80% -30%

**Capacitors (cont)**

Ckt. No.	Tektronix Part No.	Serial/Model No. Eff	Disc	Description		
C1020	283-0092-00			0.03 $\mu$ F	Cer	200 V
C1021	283-0082-00			0.01 $\mu$ F	Cer	4000 V
C1025	283-0021-00			0.001 $\mu$ F	Cer	5000 V
C1032	283-0004-00			0.02 $\mu$ F	Cer	150 V
C1033	283-0004-00			0.02 $\mu$ F	Cer	150 V
C1042	283-0079-00			0.01 $\mu$ F	Cer	250 V
C1054	283-0059-00			1 $\mu$ F	Cer	25 V
C1059	283-0079-00			0.01 $\mu$ F	Cer	250 V
C1070	283-0079-00			0.01 $\mu$ F	Cer	250 V
C1080	283-0079-00			0.01 $\mu$ F	Cer	250 V
C1082	281-0529-00			1.5 pF	Cer	500 V
C1086	283-0027-00			0.02 $\mu$ F	Cer	50 V
C1101	283-0003-00			0.01 $\mu$ F	Cer	150 V
C1102	281-0523-00			100 pF	Cer	350 V
C1103	283-0003-00			0.01 $\mu$ F	Cer	150 V
C1104	283-0003-00			0.01 $\mu$ F	Cer	150 V
C1108	281-0638-00			240 pF	Cer	500 V
C1109	283-0065-00			0.001 $\mu$ F	Cer	100 V
C1112	281-0549-00			68 pF	Cer	500 V
C1121	283-0003-00			0.01 $\mu$ F	Cer	150 V
C1126	281-0528-00			82 pF	Cer	500 V
C1128	283-0081-00			0.1 $\mu$ F	Cer	25 V
C1131	283-0065-00			0.001 $\mu$ F	Cer	100 V
C1134	283-0146-00			4.7 pF	Cer	50 V
C1135	283-0146-00			4.7 pF	Cer	50 V
C1136	283-0127-00			2.5 pF	Cer	100 V
C1137	283-0065-00			0.001 $\mu$ F	Cer	100 V
C1138	283-0146-00			4.7 pF	Cer	50 V
C1139	283-0127-00			2.5 pF	Cer	100 V
C1140	283-0127-00			2.5 pF	Cer	100 V
C1144	283-0127-00			2.5 pF	Cer	100 V
C1150	283-0127-00			2.5 pF	Cer	100 V
C1154	283-0127-00			2.5 pF	Cer	100 V
C1160	283-0127-00			2.5 pF	Cer	100 V
C1164	283-0127-00			2.5 pF	Cer	100 V
C1170	283-0065-00			0.001 $\mu$ F	Cer	100 V
C1172	283-0065-00	B010100	B049999	0.001 $\mu$ F	Cer	100 V
C1172	283-0078-00	B050000		0.001 $\mu$ F	Cer	500 V
C1174	283-0065-00	B010100	B049999	0.001 $\mu$ F	Cer	100 V
C1174	283-0078-00	B050000		0.001 $\mu$ F	Cer	500 V
C1178	283-0003-00			0.01 $\mu$ F	Cer	150 V
C1180	283-0065-00			0.001 $\mu$ F	Cer	100 V
C1187	283-0059-00			1 $\mu$ F	Cer	25 V
C1192	283-0065-00			0.001 $\mu$ F	Cer	100 V
C1193	283-0003-00			0.01 $\mu$ F	Cer	150 V

**Diodes**

Ckt. No.	Tektronix Part No.	Serial/Model No. Eff	Disc		Description
D14 } D16 } D42 D64 D74	*153-0024-00 152-0272-00 152-0194-00 152-0197-00			Germanium Silicon Silicon Silicon	1 N82A (matched pair) Varicap 6.8 pF 1N416D 1N415D Microwave Mixer
D82 D84 D86 D203 D224	152-0363-00 152-0364-00 152-0362-00 *152-0185-00 *152-0061-00			Silicon Silicon Silicon Silicon Silicon	Microwave mixer Microwave mixer Microwave Mixer Replaceable by 1N4152 Tek Spec
D252 D252 D270 D272 D277	152-0034-00 152-0280-00 *152-0185-00 *152-0185-00 152-0246-00	B010100 B090000	B089999	Zener Zener Silicon Silicon Silicon	1N753      0.4 W, 6.2 V, 10% 1N753      0.4 W, 6.2 V, 5% 1N4152 1N4152 Low leakage      0.25 W, 40 V
D279 D314 D334 D361 D362	152-0246-00 152-0231-00 *152-0107-00 *152-0153-00 *152-0185-00			Silicon Silicon Silicon Silicon Silicon	Low leakage      0.25 W, 40 V Varicap MV1872      60 V, 22 pF Replaceable by 1 N647 Replaceable by 1 N4244 1N4152
D365 D373 } D376 } D383 } D386 }	*152-0153-00 *153-0025-00 *153-0025-00			Silicon Silicon Silicon	Replaceable by 1 N4244 Selected 1 N4244 (1 pair) Selected 1 N4244 (1 pair)
D412	*152-0107-00			Silicon	Replaceable by 1 N647
D454	152-0141-02			Silicon	1N4152
D506 D550	152-0141-02 *152-0107-00			Silicon Silicon	1N4152 Replaceable by 1 N647
D612 D612 D613 D613 D640 D641 D644 D647 D647	152-0188-00 152-0079-00 152-0188-00 152-0079-00 152-0186-00 152-0186-00 *152-0075-00 152-0142-00 152-0282-00	B010100 B190000 B010100 B190000 B010100 B090000	B189999 B189999	Germanium Germanium Germanium Germanium Germanium Germanium Germanium Zener Zener	1N64 HD 1841 1N64 HD 1841 1N198 1N198 Tek Spec 1N972A      0.4 W, 30 V, 10% 1N972B      8.4 W, 30 V, 5%
D650	152-0141-02			Silicon	1N4152
D652 D660 D670 D671	152-0141-02 *152-0185-00 *152-0185-00 *152-0185-00			Silicon Silicon Silicon Silicon	1N4152 Replaceable by 1N4152 Replaceable by 1 N4152 Replaceable by 1N4152
D693 D703 D704	*152-0185-00 *152-0185-00 *152-0185-00			Silicon Silicon Silicon	Replaceable by 1N4152 Replaceable by 1 N4152 Replaceable by 1N4152
D705	152-0141-02			Silicon	1N4152
D737	152-0402-00			Tunnel	(Note diode polarity) 2.2 mA 25 pF

**Diodes (cont)**

<b>Ckt. No.</b>	<b>Tektronix Part No.</b>	<b>Serial/Model No. Eff Disc</b>	<b>Description</b>
D742	*152-0075-00	Germanium	Tek Spec
D744	*152-0075-00	Germanium	Tek Spec
D767	*152-0185-00	Silicon	Replaceable by 1 N4152
D768	*152-0185-00	Silicon	Replaceable by 1 N4152
D770	*152-0075-00	Germanium	Tek Spec
D781	152-0246-00	Silicon	Low leakage 0.25 W, 40V
D782	152-0246-00	Silicon	Low leakage 0.25 W, 40V
D784	*152-0185-00	Silicon	Replaceable by 1N4152
D798	*152-0185-00	Silicon	Replaceable by 1 N4152
D799	*152-0185-00	Silicon	Replaceable by 1 N4152
D830	*152-0185-00	Silicon	Replaceable by 1N4152
D831	*152-0185-00	Silicon	Replaceable by 1 N4152
D902A,B,C,D(4)	*152-0107-00	Silicon	Replaceable by 1 N647
D904	*152-0185-00	Silicon	Replaceable by 1N4152
D905	*152-0185-00	Silicon	Replaceable by 1N4152
D912	*152-0185-00	Silicon	Replaceable by 1N4152
D922	152-0198-00	Rectifier Bridge	MDA 962-3 (Motorola)
D923	152-0198-00	Rectifier Bridge	MDA 962-3 (Motorola)
D932	*152-0185-00	Silicon	Replaceable by 1 N4152
D940	152-0195-00	Zener	1N751A 0.4 W, 5.1 V, 5%
D952	152-0066-00	Silicon	1N3194
D953	152-0066-00	Silicon	1N3194
D964	152-0123-00	Zener	1N935A 0.4 W, 9.1 V, 5% TC
D967	*152-0185-00	Silicon	Replaceable by 1 N4152
	*152-0185-00	Silicon	Replaceable by 1N4152
D1010	*152-0107-00	Silicon	Replaceable by 1 N647
D1014	152-0192-00	Silicon	7701 -5X Varo
D1016	152-0192-00	Silicon	7701 -5X Varo
D1020	*152-0107-00	Silicon	Replaceable by 1 N647
D1050	*152-0185-00	Silicon	Replaceable by 1 N4152
D1051	*152-0185-00	Silicon	Replaceable by 1 N4152
D1054	*152-0075-00	Germanium	Tek Spec
D1073	*152-0075-00	Germanium	Tek Spec
D1116	152-0271-00	Silicon	Varicap 2.2 pF -- 26 pF
D1117	152-0271-00	Silicon	Varicap 2.2 pF -- 26 pF
D1122	152-0141-02	Silicon	1N4152
D1123	152-0141-02	Silicon	1N4152
D1124	152-0125-00	Tunnel	Selected TD3A 4.7 mA
D1134	*152-0325-00	Snap off	Tek made
D1139	*152-0325-00	Snap off	Tek made
D1142A,B	*152-0152-00	GaAs	(1 pair) Tek made
D1152A,B	*152-0152-00	GaAs	(1 pair) Tek made
D1162A,B	*152-0152-00	GaAs	(1 pair) Tek made
D1170	*152-0185-00	Silicon	Replaceable by 1N4152
D1174	*152-0185-00	Silicon	Replaceable by 1 N4152
D1196	*152-0185-00	Silicon	Replaceable by 1N4152
D1198	*152-0185-00	Silicon	Replaceable by 1N4152

**Fuses**

<b>Ckt. No.</b>	<b>Tektronix Part No.</b>	<b>Serial/Model No. Eff</b>	<b>Disc</b>	<b>Description</b>
F900	159-0025-00			0.5 A 3AG Fast-Blo
F902	159-0022-00			1 A 3AG Fast-Blo
F1008	159-0022-00			1 A 3AG Fast-Blo

**Filter**

FL900	119-0095-00	B010100	B059999	Low Pass 275 V AC
FL900	119-0095-03	B060000		Low Pass 275 V AC

**Connectors**

J1	131-0390-00			BNC, female
J10	131-0372-00			Coaxial
J14	131-0372-00			Coaxial
J18	131-0372-00			Coaxial
J20	131-0372-00			Coaxial
J34	131-0372-00			oa
J40A <sup>2</sup>				
J40B <sup>2</sup>				
J41A <sup>2</sup>				
J41B <sup>2</sup>				
J42A <sup>2</sup>				
J42B <sup>2</sup>				
J45 <sup>3</sup>				
J46 <sup>3</sup>				
J47 <sup>3</sup>				
J50 <sup>4</sup>				
J51 <sup>4</sup>				
J52 <sup>4</sup>				
J65	*103-0057-00			Adapter, Snap-On
J69 <sup>5</sup>				
J71 <sup>2</sup>				
J72 <sup>2</sup>				
J73 <sup>2</sup>				
J75 <sup>2</sup>				
J80	131-0372-00			Coaxial
J94	131-0372-00			Coaxial
J100	131-0372-00			Coaxial
J109	131-0372-00			Coaxial
J120	131-0372-00			Coaxial
J147	131-0372-00			Coaxial
J148	131-0372-00			Coaxial

<sup>2</sup>Furnished as a unit with Oscillator \*(119-0106-00)

<sup>3</sup>Furnished as a unit with Diplexer (119-0100-00)

<sup>4</sup>Furnished as a unit with Resistive "T" Network 119-0091-00)

<sup>5</sup>Furnished as a unit with Mixer \*(119-0064-00)

**Connectors (cont)**

Ckt. No.	Tektronix Part No.	Serial/Model Eff	No. Disc	Description
J151	131-0372-00			Coaxial
J188	131-0372-00			Coaxial
J363	131-0372-00			Coaxial
J370	131-0372-00			Coaxial
J373	131-0372-00			Coaxial
J376	131-0372-00			Coaxial
J379	131-0372-00			Coaxial
J401	131-0372-00			Coaxial
J470	131-0372-00			Coaxial
J501	131-0372-00			Coaxial
J650	131-0106-01			Coaxial, 1 contact, female
J700	131-0106-01			Coaxial, 1 contact, female
J790	131-0106-01			Coaxial, 1 contact, female
J1120	131-0352-01			BNC
J1142	131-0391-00			Coaxial, male
J1152	131-0391-00			Coaxial, male
J1162	131-0391-00			Coaxial, male

**Inductors**

L10	*108-0220-00	B010100	B119999	0.15 $\mu$ H
L10	*108-0283-00	B120000		0.13 $\mu$ H
L21	*108-0388-00			35 nH
L23	*108-0385-00			8 nH
L24	*108-0390-00			45 nH
L26	*108-0387-00			24 nH
L27	*108-0389-00			40 nH
L29	*108-0386-00			15 nH
L30	*108-0389-00			40 nH
L51	*108-0437-00			Choke R.F.
L65 <sup>o</sup>				
L66	*108-0394-00			30 $\mu$ H
L67 <sup>o</sup>				
L68 <sup>o</sup>				
L81	*108-0380-00			32 nH
L83	*108-0377-00			7 nH
L84	*108-0382-00			41 nH
L86	*108-0379-00			22 nH
L87	*108-0381-00			36 nH
L89	*108-0378-00			14 nH
L90	*108-0381-00			36 nH
L101	*108-0371-00			0.23 $\mu$ H
L102	*108-0370-00			0.14 $\mu$ H
L104	*108-0369-00			0.12 $\mu$ H
L105	*108-0401-00			14 nH
L106	*108-0369-00			0.12 $\mu$ H
L107	*108-0370-00			0.14 $\mu$ H
L108	*108-0371-00			0.23 $\mu$ H

<sup>o</sup>Furnished as a unit with Mixer \*(1 19-0064-00)

**Inductors (cont)**

Ckt. No.	Tektronix Part No.	Serial/Model No. Eff	Disc	Description	
L124	*108-0373-00	B010100	B039999	56 nH	
L124	*108-0374-00	B040000		55 nH	
L134	*114-0205-00			54-66 nH, Var	Core 276-0506-00
L144	*114-0206-00			234-286 nH, Var	Core 276-0506-00
L147	*114-0205-00			54-66 nH, Var	Core 276-0506-00
L151	*108-0310-00			0.09 $\mu$ H	
L188	*108-0310-00			0.09 $\mu$ H	
L222	276-0507-00	XB010112		Core, Ferramic Suppressor	
L313	*108-0215-00			1.1 $\mu$ H	
L314 <sup>†</sup>					
L320	*108-0215-00			1.1 $\mu$ H	
L325	276-0507-00			Core, Ferramic Suppressor	
L333	*108-0215-00			1.1 $\mu$ H	
L343	*108-0215-00			1.1 $\mu$ H	
L348	*108-0304-00			45 nH	
L358	*108-0372-00			27 nH	
L384	*108-0374-00			55 nH	
L385	*108-0374-00			55 nH	
L444	*114-0207-00			180-220 nH, Var	Core 276-0506-00
L446	*108-0215-00			1.1 $\mu$ H	
L450(3)	276-0507-00			Core, Ferramic Suppressor	
L456	276-0507-00			Core, Ferramic Suppressor	
L466	276-0507-00			Core, Ferramic Suppressor	
L508	108-0363-00			67 $\mu$ H	
L534	108-0226-00			100 $\mu$ H	
L602	*108-0415-00			1.5 $\mu$ H	
L605	*108-0415-00			1.5 $\mu$ H	
L608	*108-0415-00			1.5 $\mu$ H	
L611	*108-0415-00			1.5 $\mu$ H	
L998	*108-0317-00			15 $\mu$ H	
L1 035	*108-0321-00			Beam Rotator	
L1054	108-0324-00			10 mH	
L1 104	114-0178-00			1.3-3 mH, Var	Core not replaceable
L1108	*114-0218-00			70-120 $\mu$ H, Var	Core 276-0506-00
L1124	*108-0215-00			1.1 $\mu$ H	
L11 96	276-0554-00			Core, Toroid Ferrite	
LR413	*108-0368-00			10 $\mu$ H (wound on a 1 k $\Omega$ , 1/2 W resistor)	
LR423	*108-0367-00			1 $\mu$ H (wound on a 1 k $\Omega$ , 1/4 W resistor)	
LR427	*108-0367-00			1 $\mu$ H (wound on a 1 k $\Omega$ , 1/4 W resistor)	
LR433	*108-0367-00			1 $\mu$ H (wound on a 1 k $\Omega$ , 1/4 W resistor)	
LR437	*108-0368-00			10 $\mu$ H (wound on a 1 k $\Omega$ , 1/2 W resistor)	
LR443	*108-0368-00			10 $\mu$ H (wound on a 1 k $\Omega$ , 1/2 W resistor)	
LR453	*108-0368-00			10 $\mu$ H (wound on a 1 k $\Omega$ , 1/2 W resistor)	
LR457	*108-0368-00			10 $\mu$ H (wound on a 1 k $\Omega$ , 1/2 W resistor)	
LR463	*108-0368-00			10 $\mu$ H (wound on a 1 k $\Omega$ , 1/2 W resistor)	
LR467	*108-0368-00			10 $\mu$ H (wound on a 1 k $\Omega$ , 1/2 W resistor)	

<sup>†</sup>Part of Sweeper Circuit Board.

### Transistors

Ckt. No.	Tektronix Part No.	Serial/Model No. Eff                  Disc	Material	Description
Q54	151-0207-00		Silicon	2N3415
Q64	151-0207-00		Silicon	2N3415
Q120	151-0180-00	B010100          B039999	Silicon	40235 (RCA)
Q120	*151-0230-00	B040000	Silicon	Replacable by 40235 (RCA)
Q130	151-0180-00	B010100          B039999	Silicon	40235 (RCA)
Q130	*151-0230-00	B040000	Silicon	Replacable by 40235 (RCA)
Q140	151-0181-00		Silicon	40242 (RCA)
Q200	151-0188-00		Silicon	2N3906
Q220	*151-0192-00		Silicon	Replacable by MPS 6521
Q230	151-0150-00		Silicon	2N3440
Q240	151-0157-00		Silicon	40232 (RCA)
Q260	*151-0104-00		Silicon	Replacable by 2N2919
Q270	151-0157-00		Silicon	40232 (RCA)
Q280	*151-0192-00		Silicon	Replacable by MPS 6521
Q290	*151-0192-00		Silicon	Replacable by MPS 6521
Q310	151-0173-00		Silicon	2N3478
Q320	*151-0153-00		Silicon	Replacable by 2N2923
Q340	151-0173-00		Silicon	2N3478
Q350	151-0173-00		Silicon	2N3478
Q420	151-0181-00		Silicon	40242 (RCA)
Q430	151-0181-00		Silicon	40242 (RCA)
Q440	151-0175-00		Silicon	2N3662
Q450	151-0175-00		Silicon	2N3662
Q460	151-0175-00		Silicon	2N3662
Q510	151-0181-00		Silicon	40242 (RCA)
Q520	151-0175-00		Silicon	2N3662
Q530	151-0175-00		Silicon	2N3662
Q620	151-0175-00		Silicon	2N3662
Q630	151-0175-00		Silicon	2N3662
Q631	*151-0199-00		Silicon	Replacable by MPS 3640
Q640	151-0188-00		Silicon	2N3906
Q641	151-0190-00		Silicon	2N3904
Q660	*151-0192-00		Silicon	Replacable by MPS 6521
Q670	*151-0192-00		Silicon	Replacable by MPS 6521
Q680	151-0188-00		Silicon	2N3906
Q681	151-0150-00		Silicon	2N3440
Q682	151-0150-00		Silicon	2N3440
Q690	*151-0192-00		Silicon	Replacable by MPS 6521
Q700	*151-0192-00		Silicon	Replacable by MPS 6521
Q710	151-0188-00		Silicon	2N3906
Q720	*151-0192-00		Silicon	Replacable by MPS 6521
Q730	*151-0192-00		Silicon	Replacable by MPS 6521
Q731	*151-0192-00		Silicon	Replacable by MPS 6521
Q740	151-0188-00		Silicon	2N3906
Q750	*151-0192-00		Silicon	Replacable by MPS 6521
Q751	*151-0192-00		Silicon	Replacable by MPS 6521
Q752	*151-0192-00		Silicon	Replacable by MPS 6521



**Transistors (cont)**

Ckt. No.	Tektronix Part No.	Serial/Model No. Eff	Disc	Description
Q760	*151-0192-00		Silicon	Replaceable by MPS 6521
Q761	*151-0192-00		Silicon	Replaceable by MPS 6521
Q770	151-0188-00		Silicon	2N3906
Q771	151-0188-00		Silicon	2N3906
Q790	*151-0192-00		Silicon	Replaceable by MPS 6521
Q791	*151-0192-00		Silicon	Replaceable by MPS 6521
Q800	*151-0192-00		Silicon	Replaceable by MPS 6521
Q810	151-0150-00		Silicon	2N3440
Q820	151-0150-00		Silicon	2N3440
Q830	*151-0192-00		Silicon	Replaceable by MPS 6521
Q831	*151-0192-00		Silicon	Replaceable by MPS 6521
Q900	*151-0192-00		Silicon	Replaceable by MPS 6521
Q901	*151-0149-00		Silicon	Selected from 2N3441
Q910	151-0150-00		Silicon	2N3440
Q911	*151-0192-00		Silicon	Replaceable by MPS 6521
Q920	*151-0148-00		Silicon	Selected 40250 (RCA)
Q921	151-0207-00		Silicon	2N3415
Q922	151-0207-00		Silicon	2N3415
Q930	*151-0192-00		Silicon	Replaceable by MPS 6521
Q940	*151-0148-00		Silicon	Selected 40250 (RCA)
Q950	*151-0148-00		Silicon	Selected 40250 (RCA)
Q951	*151-0192-00		Silicon	Replaceable by MPS 6521
Q952	151-0188-00		Silicon	2N3906
Q960	*151-0192-00		Silicon	Replaceable by MPS 6521
Q961	*151-0192-00		Silicon	Replaceable by MPS 6521
Q1000	*151-0192-00		Silicon	Replaceable by MPS 6521
Q1001	151-0188-00		Silicon	2N3906
Q1002	*151-0136-00		Silicon	Replaceable by 2N3053
Q1003	*151-0140-00		Silicon	Selected from 2N3055
Q1050	*151-0192-00		Silicon	Replaceable by MPS 6521
Q1051	*151-0192-00		Silicon	Replaceable by MPS 6521
Q1070	151-0188-00		Silicon	2N3906
Q1080	151-0150-00		Silicon	2N3440
Q1081	151-0188-00		Silicon	2N3906
Q1100	*151-0108-00		Silicon	Replaceable by 2N2501
Q1110	*151-0192-00		Silicon	Replaceable by MPS 6521
Q1120	151-0181-00		Silicon	40242 (RCA)
Q1121	*153-0545-00		Silicon	Selected from 2N2501
Q1130	151-0150-00		Silicon	2N3440
Q1170	*151-0192-00		Silicon	Replaceable by MPS 6521
Q1180	*151-0192-00		Silicon	Replaceable by MPS 6521
Q1190	*151-0192-00		Silicon	Replaceable by MPS 6521

**Resistors**

Resistors are fixed, composition,  $\pm 10\%$  unless otherwise indicated.

R10	315-0510-00	B010100	B119999	51 $\Omega$	1/4 W	5%
R10	317-0510-00	B120000		51 $\Omega$	1/8 W	5%
R11	317-0510-00	XB120000		51 $\Omega$	1/8 W	5%
R12	317-0510-00	XB120000		51 $\Omega$	1/8 W	5%
R13	311-0643-00	XB120000		50 $\Omega$ , Var		

## Resistors (cont)

Ckt. No.	Tektronix Part No.	Serial/Model No. Eff	Disc		Description	
R14	315-0470-00	B010100	B119999	47 $\Omega$	Selected (nominal value)	
R14	317-0151-00	B120000		150 $\Omega$	Selected (nominal value)	
R16	315-0330-00	B010100	B119999	33 $\Omega$	Selected (nominal value)	
R16	317-0151-00	B120000		150 $\Omega$	Selected (nominal value)	
R17	315-0200-00	B010100	B119999	20 $\Omega$	1/4 W	5%
R17	317-0200-00	B120000		20 $\Omega$	1/8 W	5%
R18	315-0101-00	B010100	B119999	100 $\Omega$	1/4 W	5%
R18	317-0101-00	B120000		100 $\Omega$	1/8 W	5%
R20	317-0240-00	XB120000		24 $\Omega$	1/8 W	5%
R21	317-0510-00	XB120000		51 $\Omega$	1/8 W	5%
R40	308-0319-00			4.5 k $\Omega$	3 W WW	1%
R41	308-0319-00			4.5 k $\Omega$	3 W WW	1%
R42	301-0821-00			820 $\Omega$	1/2 W	5%
R43	317-0201-00			200 $\Omega$	1/8 W	5%
R45	308-0297-00			24.7 $\Omega$	3 W WW	1%
R46	308-0297-00			24.7 $\Omega$	3 W WW	1%
R51	315-0563-00			56 k $\Omega$	1/4 W	5%
R55 <sup>a</sup>	311-0662-00			10 k $\Omega$ , Var		
R66	315-0563-00			56 k $\Omega$	1/4 W	5%
R123	315-0101-00			100 $\Omega$	1/4 W	5%
R124	315-0471-00	XB040000		470 $\Omega$	1/4 W	5%
R128	315-0332-00			3.3 k $\Omega$	1/4 W	5%
R130	315-0221-00			220 $\Omega$	1/4 W	5%
R133	315-0101-00			100 $\Omega$	1/4 W	5%
R134	315-0131-00			130 $\Omega$	1/4 W	5%
R137	315-0101-00	B010100	B039999	100 $\Omega$	1/4 W	5%
R137	315-0330-00	B040000		33 $\Omega$	Selected (nominal value)	
R138	315-0182-00			1.8 k $\Omega$	1/4 W	5%
R140	315-0221-00			220 $\Omega$	1/4 W	5%
R143	315-0101-00			100 $\Omega$	1/4 W	5%
R148	315-0101-00			100 $\Omega$	1/4 W	5%
R149	315-0472-00			4.7 k $\Omega$	1/4 W	5%
R158	315-0620-00			62 $\Omega$	1/4 W	5%
R159	315-0241-00			240 $\Omega$	1/4 W	5%
R160	315-0620-00			62 $\Omega$	1/4 W	5%
R163	315-0680-00			68 $\Omega$	1/4 W	5%
R164	315-0151-00			150 $\Omega$	1/4 W	5%
R165	315-0680-00			68 $\Omega$	1/4 W	5%
R168	315-0121-00			120 $\Omega$	1/4 W	5%
R169	315-0510-00			51 $\Omega$	1/4 W	5%
R170	315-0121-00			120 $\Omega$	1/4 W	5%
R173	315-0221-00			220 $\Omega$	1/4 W	5%
R174	315-0240-00			24 $\Omega$	1/4 W	5%
R175	315-0221-00			220 $\Omega$	1/4 W	5%
R178	315-0431-00			430 $\Omega$	1/4 W	5%
R179	315-0120-00			12 $\Omega$	1/4 W	5%
R180	315-0431-00			430 $\Omega$	1/4 W	5%

<sup>a</sup>Furnished as a unit with SW55.

## Resistors (cont)

Ckt. No.	Tektronix Part No.	Serial/Model No. Eff Disc	Description
R183	315-0911-00	910 $\Omega$	$\frac{1}{4}$ W 5%
R184	307-0107-00	5.6 $\Omega$	$\frac{1}{4}$ W 5%
R185	315-0911-00	910 $\Omega$	$\frac{1}{4}$ W 5%
R200	321-0256-00	4.53 k $\Omega$	$\frac{1}{8}$ W Prec 1%
R201	323-0369-00	68.1 k $\Omega$	$\frac{1}{2}$ W Prec 1%
R203	311-0633-00	5 k $\Omega$ , Var	
R204	315-0752-00	7.5 k $\Omega$	$\frac{1}{4}$ W 5%
R206	321-0296-00	11.8 k $\Omega$	$\frac{1}{8}$ W Prec 1%
R208	311-0614-00	30 k $\Omega$ , Var	
R209	321-0238-00	2.94 k $\Omega$	$\frac{1}{8}$ W Prec 1%
R210A	321-0231-00	2.49 k $\Omega$	$\frac{1}{8}$ W Prec 1%
R210B	321-0164-00	499 $\Omega$	$\frac{1}{8}$ W Prec 1%
R210C	321-0193-00	1 k $\Omega$	$\frac{1}{8}$ W Prec 1%
R210D	321-0164-00	499 $\Omega$	$\frac{1}{8}$ W Prec 1%
R210E	321-0135-00	249 $\Omega$	$\frac{1}{8}$ W Prec 1%
R210F	321-0068-00	49.9 $\Omega$	$\frac{1}{8}$ W Prec 1%
R210G	321-0097-00	100 $\Omega$	$\frac{1}{8}$ W Prec 1%
R210H	321-0068-00	49.9 $\Omega$	$\frac{1}{8}$ W Prec 1%
R210I	321-0047-00	30.1 $\Omega$	$\frac{1}{8}$ W Prec 1%
R210J	321-0001-00	10 $\Omega$	$\frac{1}{8}$ W Prec 1%
R210K	321-0001-00	10 $\Omega$	$\frac{1}{8}$ W Prec 1%
R222	321-0143-00	301 $\Omega$	$\frac{1}{8}$ W Prec 1%
R224	315-0101-00	100 $\Omega$	$\frac{1}{4}$ W 5%
R225	315-0102-00	1 k $\Omega$	$\frac{1}{4}$ W 5%
R226	321-0226-00	2.21 k $\Omega$	$\frac{1}{8}$ W Prec 1%
R227	321-0254-00	4.32 k $\Omega$	$\frac{1}{8}$ W Prec 1%
R228	322-0382-00	93.1 k $\Omega$	$\frac{1}{4}$ W Prec 1%
R229	315-0101-00	100 $\Omega$	$\frac{1}{4}$ W 5%
R232	321-0278-00	7.68 k $\Omega$	$\frac{1}{8}$ W Prec 1%
R233	321-0431-00	301 k $\Omega$	$\frac{1}{8}$ W Prec 1%
R234	311-0614-00	30 k $\Omega$ , Var	
R236	321-0347-00	40.2 k $\Omega$	$\frac{1}{8}$ W Prec 1%
R237	321-0368-00	66.5 k $\Omega$	$\frac{1}{8}$ W Prec 1%
R240	321-0205-00	1.33 k $\Omega$	$\frac{1}{8}$ W Prec 1%
R242	321-0233-00	2.61 k $\Omega$	$\frac{1}{8}$ W Prec 1%
R250	311-0633-00	5 k $\Omega$ , Var	
R251	311-0644-00	20 k $\Omega$ , Var	
R252	323-0348-00	41.2 k $\Omega$	$\frac{1}{2}$ W Prec 1%
R254	321-0385-00	100 k $\Omega$	$\frac{1}{8}$ W Prec 1%
R255	321-0164-00	499 $\Omega$	$\frac{1}{8}$ W Prec 1%
R256	311-0590-00	2 k $\Omega$ , Var	
R258	322-0481-00	1-M $\Omega$	$\frac{1}{4}$ W Prec 1%
R259	311-0580-00	50 k $\Omega$ , Var	
R260	321-0423-00	249 k $\Omega$	$\frac{1}{8}$ W Prec 1%
R261	321-0143-00	301 $\Omega$	$\frac{1}{8}$ W Prec 1%

## Resistors (cont)

Ckt. No.	Tektronix Part No.	Serial/Model No. Eff Disc	Description			
R263	321-0143-00	301 $\Omega$	$\frac{1}{8}$ W	Prec		1%
R264	321-0423-00	249 k $\Omega$	$\frac{1}{8}$ W	Prec		1%
R266	321-0135-00	249 $\Omega$	$\frac{1}{8}$ W	Prec		1%
R267	321-0135-00	249 $\Omega$	$\frac{1}{8}$ W	Prec		1%
R272	321-0222-00	2 k $\Omega$	$\frac{1}{8}$ W	Prec		1%
R274	321-0205-00	1.33 k $\Omega$	$\frac{1}{8}$ W	Prec		1%
R277	315-0272-00	2.7 k $\Omega$	$\frac{1}{4}$ W			5%
R279	315-0274-00	270 k $\Omega$	$\frac{1}{4}$ W			5%
R280	321-0423-00	249 k $\Omega$	$\frac{1}{8}$ W	Prec		1%
R282	315-0101-00	100 $\Omega$	$\frac{1}{4}$ W			5%
R283	321-0097-00	100 $\Omega$	$\frac{1}{8}$ W	Prec		1%
R286	315-0512-00	5.1 k $\Omega$	$\frac{1}{4}$ W			5%
R290	311-0609-00	2 k $\Omega$ , Var				
R291	321-0280-00	8.06 k $\Omega$	$\frac{1}{8}$ W	Prec		1%
R293	315-0510-00	51 $\Omega$	$\frac{1}{4}$ W			5%
R294	315-0562-00	5.6 k $\Omega$	$\frac{1}{4}$ W			5%
R295	315-0202-00	2 k $\Omega$	$\frac{1}{4}$ W			5%
R296	315-0102-00	1 k $\Omega$	$\frac{1}{4}$ W			5%
R300	315-0102-00	1 k $\Omega$	$\frac{1}{4}$ W			5%
R310	315-0562-00	5.6 k $\Omega$	$\frac{1}{4}$ W			5%
R311	315-0392-00	3.9 k $\Omega$	$\frac{1}{4}$ W			5%
R316	315-0221-00	220 $\Omega$	$\frac{1}{4}$ W			5%
R333	321-0233-00	2.61 k $\Omega$	$\frac{1}{8}$ W	Prec		1%
R334	315-0431-00	430 $\Omega$	$\frac{1}{4}$ W			5%
R346	315-0680-00	68 $\Omega$	$\frac{1}{4}$ W			5%
R356	315-0680-00	68 $\Omega$	$\frac{1}{4}$ W			5%
R361	321-0395-00	127 k $\Omega$	$\frac{1}{8}$ W	Prec		1%
R363	315-0221-00	220 $\Omega$	$\frac{1}{4}$ W			5%
R365	315-0102-00	1 k $\Omega$	$\frac{1}{4}$ W			5%
R368	311-0633-00	5 k $\Omega$ , Var				
R373	315-0510-00	51 $\Omega$	$\frac{1}{4}$ W			5%
R376	315-0510-00	51 $\Omega$	$\frac{1}{4}$ W			5%
R383	315-0681-00	680 $\Omega$	$\frac{1}{4}$ W			5%
R384	321-0097-00	100 $\Omega$	$\frac{1}{8}$ W	Prec		1%
R385	321-0097-00	100 $\Omega$	$\frac{1}{8}$ W	Prec		1%
R401	315-0680-00	68 $\Omega$	$\frac{1}{4}$ W			5%
R410	315-0393-00	39 k $\Omega$		Selected (nominal value)		
R411A	311-0310-00	5 k $\Omega$ , Var				
R414	315-0512-00	5.1 k $\Omega$	$\frac{1}{4}$ W			5%
R416	315-0102-00	1 k $\Omega$	$\frac{1}{4}$ W			5%
R426	315-0102-00	1 k $\Omega$	$\frac{1}{4}$ W			5%
R436	315-0102-00	1 k $\Omega$	$\frac{1}{4}$ W			5%
R448	315-0472-00	4.7 k $\Omega$	$\frac{1}{4}$ W			5%
R454	315-0103-00	10 k $\Omega$	$\frac{1}{4}$ W			5%
R456	315-0472-00	4.7 k $\Omega$	$\frac{1}{4}$ W			5%

## Resistors (cont)

Ckt. No.	Tektronix Part No.	Serial/Model No. Eff	Disc	Description	
R464	315-0103-00		10 k $\Omega$	1/4 W	5%
R466	315-0472-00		4.7 k $\Omega$	1/4 W	5%
R501	317-0151-00		150 $\Omega$	1/10 W	5%
R502	317-0151-00		150 $\Omega$	1/10 W	5%
R514	315-0470-00		47 $\Omega$	1/4 W	5%
R516	315-0242-00		2.4 k $\Omega$	1/4 W	5%
R517	315-0242-00		2.4 k $\Omega$	1/4 W	5%
R524	315-0470-00		47 $\Omega$	1/4 W	5%
R525	315-0202-00		2 k $\Omega$	1/4 W	5%
R530	315-0301-00		300 $\Omega$	1/4 W	5%
R531	315-0203-00		20 k $\Omega$	1/4 W	5%
R532	315-0562-00		5.6 k $\Omega$	1/4 W	5%
R534	315-0102-00		1 k $\Omega$	1/4 W	5%
R537	315-0101-00		100 $\Omega$	1/4 W	5%
R539	315-0102-00		1 k $\Omega$	1/4 W	5%
R540	323-0365-00		61.9 k $\Omega$	1/2 W	Prec 1%
R541	315-0204-00		200 k $\Omega$	1/4 W	5%
R543	311-0607-00		10 k $\Omega$ , Var		
R550	315-0221-00		220 $\Omega$	1/4 W	5%
R551	315-0161-00		160 $\Omega$	1/4 W	5%
R552	315-0111-00		110 $\Omega$	1/4 W	5%
R553	315-0151-00		150 $\Omega$	1/4 W	5%
R554	315-0331-00		330 $\Omega$	1/4 W	5%
R555	315-0511-00		510 $\Omega$	1/4 W	5%
R556	315-0561-00		560 $\Omega$	1/4 W	5%
R557	315-0154-00		150 k $\Omega$	1/4 W	5%
R558	315-0624-00		620 k $\Omega$	1/4 W	5%
R559	315-0624-00		620 k $\Omega$	1/4 W	5%
R600	315-0471-00		470 $\Omega$	1/4 W	5%
R612	315-0681-00		680 $\Omega$	1/4 W	5%
R617	315-0302-00		3 k $\Omega$	1/4 W	5%
R620	315-0471-00		470 $\Omega$	1/4 W	5%
R622	315-0100-00		10 $\Omega$	1/4 W	5%
R623	315-0182-00		1.8 k $\Omega$	1/4 W	5%
R625	315-0102-00		1 k $\Omega$	1/4 W	5%
R626	315-0103-00		10 k $\Omega$	1/4 W	5%
R627	315-0472-00		4.7 k $\Omega$	1/4 W	5%
R628	315-0103-00		10 k $\Omega$	1/4 W	5%
R630	315-0100-00		10 $\Omega$	1/4 W	5%
R631	315-0100-00		10 $\Omega$	1/4 W	5%
R633	315-0471-00		470 $\Omega$	1/4 W	5%
R635	315-0100-00		10 $\Omega$	1/4 W	5%
R636	315-0100-00		10 $\Omega$	1/4 W	5%
R642	315-0104-00		100 k $\Omega$	1/4 W	5%
R644	315-0105-00		1 M $\Omega$	1/4 W	5%

## Resistors (cont)

Ckt. No.	Tektronix Part No.	Serial/Model No. Eff	Disc	Description		
R646	308-0413-00			16 k $\Omega$	3 W	WW
R650	315-0683-00			68 k $\Omega$	1/4 W	5%
R651	315-0273-00			27 k $\Omega$	1/4 W	5%
R653	315-0102-00			1 k $\Omega$	1/4 W	5%
R655	315-0104-00			100 k $\Omega$	1/4 W	5%
R657	315-0103-00			10 k $\Omega$	1/4 W	5%
R658	315-0622-00			6.2 k $\Omega$	1/4 W	5%
R659	315-0621-00			620 $\Omega$	1/4 W	5%
R660	315-0103-00			10 k $\Omega$	1/4 W	5%
R663	321-0391-00	B010100	B099999	115 k $\Omega$	1/8 W	Prec
R663	321-0387-00	B100000		105 k $\Omega$	1/8 W	Prec
R664	321-0369-00			68.1 k $\Omega$	1/8 W	Prec
R665	311-0642-00			20 k $\Omega$ , Var		1%
R666	315-0334-00			330 k $\Omega$	1/4 W	5%
R667	315-0474-00			470 k $\Omega$	1/4 W	5%
R668	321-0385-00			100 k $\Omega$	1/8 W	Prec
R669	323-0495-00			1.4 M $\Omega$	1/2 W	Prec
R671	321-0444-00			412 k $\Omega$	1/8 W	Prec
R672	311-0660-00			200 k $\Omega$ , Var		5%
R674	301-0623-00			62 k $\Omega$	1/2 W	5%
R675	315-0102-00			1 k $\Omega$	1/4 W	5%
R677	321-0289-00			10 k $\Omega$	1/8 W	Prec
R680	315-0100-00			10 $\Omega$	1/4 W	5%
R682	315-0332-00			3.3 k $\Omega$	1/4 W	5%
R684	315-0474-00			470 k $\Omega$	1/4 W	5%
R685	*310-0632-00			30 k $\Omega$	4 W	WW
R686	321-0193-00			1 k $\Omega$	1/8 W	Prec
R687	321-0193-00			1 k $\Omega$	1/8 W	Prec
R689	*310-0632-00			30 k $\Omega$	4 W	WW
R692	321-0247-00			3.65 k $\Omega$	1/8 W	Prec
R693	321-0193-00			1 k $\Omega$	1/8 W	Prec
R695	321-0155-00			402 $\Omega$	1/8 W	Prec
R696	315-0100-00			10 $\Omega$	1/4 W	5%
R700	315-0104-00			100 k $\Omega$	1/4 W	5%
R701	321-0385-00			100 k $\Omega$	1/8 W	Prec
R702 <sup>9</sup>	311-0640-00			20 k $\Omega$ , Var		1%
R703	315-0102-00			1 k $\Omega$ -	1/4 W	5%
R704	321-0385-00			100 k $\Omega$	1/8 W	Prec
R705	321-0289-00			10 k $\Omega$	1/8 W	Prec
R707	323-0399-00			140 k $\Omega$	1/2 W	Prec
R709	321-0289-00	B010100	B099999	10 k $\Omega$	1/8 W	Prec
R709	321-0288-00	B100000		9.76 k $\Omega$	1/8 W	Prec
R712	315-0100-00			10 $\Omega$	1/4 W	5%
R714	315-0103-00			10 k $\Omega$	1/4 W	5%
R715	315-0101-00			100 $\Omega$	1/4 W	5%
R717	315-0101-00			100 $\Omega$	1/4 W	5%
R718	315-0101-00			100 $\Omega$	1/4 W	5%

<sup>9</sup>Furnished as a unit with SW702.

## Resistors (cont)

Ckt. No.	Tektronix Part No.	Serial/Model No. Eff	Disc		Description		
R720	315-0104-00			100 $\Omega$	$\frac{1}{4}$ W		5%
R721	315-0332-00			3.3 k $\Omega$	$\frac{1}{4}$ W		5%
R722	315-0101-00			100 $\Omega$	$\frac{1}{4}$ W		5%
R724	311-0613-00			100 k $\Omega$ , Var			
R725	315-0304-00	B010100	B099999	300 k $\Omega$	$\frac{1}{4}$ W		5%
R725	315-0204-00	B100000		200 k $\Omega$	$\frac{1}{4}$ W		5%
R730	315-0101-00			100 $\Omega$	$\frac{1}{4}$ W		5%
R732	321-0231-00			2.49 k $\Omega$	$\frac{1}{8}$ W	Prec	1%
R733	315-0101-00			100 $\Omega$	$\frac{1}{4}$ W		5%
R735	315-0101-00			100 $\Omega$	$\frac{1}{4}$ W		5%
R736	315-0154-00			150 k $\Omega$	$\frac{1}{4}$ W		5%
R737	315-0101-00			100 $\Omega$	$\frac{1}{4}$ W		5%
R739	315-0100-00			10 $\Omega$	$\frac{1}{4}$ W		5%
R741	315-0224-00			220 k $\Omega$	$\frac{1}{4}$ W		5%
R743	321-0222-00			2 k $\Omega$	$\frac{1}{8}$ W	Prec	1%
R744	321-0222-00			2 k $\Omega$	$\frac{1}{8}$ W	Prec	1%
R745	321-0280-00			8.06 k $\Omega$	$\frac{1}{8}$ W	Prec	1%
R750	321-0209-00			1.47 k $\Omega$	$\frac{1}{8}$ W	Prec	1%
R752	321-0222-00			2 k $\Omega$	$\frac{1}{8}$ W	Prec	1%
R753	315-0100-00			10 $\Omega$	$\frac{1}{4}$ W		5%
R755	321-0289-00			10 k $\Omega$	$\frac{1}{8}$ W	Prec	1%
R756	315-0101-00			100 $\Omega$	$\frac{1}{4}$ W		5%
R757	321-0280-00			8.06 k $\Omega$	$\frac{1}{8}$ W	Prec	1%
R758	321-0299-00			12.7 k $\Omega$	$\frac{1}{8}$ W	Prec	1%
R759	311-0633-00			5 k $\Omega$ , Var			
R761	315-0472-00			4.7 k $\Omega$	$\frac{1}{4}$ W		5%
R762	315-0101-00			100 $\Omega$	$\frac{1}{4}$ W		5%
R763	315-0102-00			1 k $\Omega$	$\frac{1}{4}$ W		5%
R765	315-0103-00			10 k $\Omega$	$\frac{1}{4}$ W		5%
R768	315-0332-00			3.3 k $\Omega$	$\frac{1}{4}$ W		5%
R770	315-0104-00			100 k $\Omega$	$\frac{1}{4}$ W		5%
R771	315-0103-00			10 k $\Omega$	$\frac{1}{4}$ W		5%
R773	321-0213-00			1.62 k $\Omega$	$\frac{1}{8}$ W	Prec	1%
R775	321-0239-00			3.01 k $\Omega$	$\frac{1}{8}$ W	Prec	1%
R777	321-0210-00			1.5 k $\Omega$	$\frac{1}{8}$ W	Prec	1%
R778	315-0332-00			3.3 k $\Omega$	$\frac{1}{4}$ W		5%
R779	315-0101-00			100 $\Omega$	$\frac{1}{4}$ W		5%
R781	321-0207-00			1.4 k $\Omega$	$\frac{1}{8}$ W	Prec	1%
R782	321-0239-00			3.01 k $\Omega$	$\frac{1}{8}$ W	Prec	1%
R784	315-0103-00			10 k $\Omega$	$\frac{1}{4}$ W		5%
R785A	323-0463-06			649 k $\Omega$	$\frac{1}{2}$ W	Prec	$\frac{1}{4}$ %
R785B	323-0425-06			261 k $\Omega$	$\frac{1}{2}$ W	Prec	$\frac{1}{4}$ %
R785C	323-0396-06			130 k $\Omega$	$\frac{1}{2}$ W	Prec	$\frac{1}{4}$ %
R786 <sup>11</sup>	311-0182-00			200 k $\Omega$ , Var			
R787	311-0607-00			10 k $\Omega$ , Var			
R788	315-0101-00			100 $\Omega$	$\frac{1}{4}$ W		5%

<sup>11</sup>Furnished as a unit with SW786.

## Resistors (cont)

Ckt. No.	Tektronix Part No.	Serial/Model No. Eff	Disc	Description		
R789	315-0101-00			100 $\Omega$	$\frac{1}{4}$ W	5%
R790	315-0623-00			62 k $\Omega$	$\frac{1}{4}$ W	5%
R791	315-0621-00			620 $\Omega$	$\frac{1}{4}$ W	5%
R793	315-0101-00			100 $\Omega$	$\frac{1}{4}$ W	5%
R794	315-0101-00			100 $\Omega$	$\frac{1}{4}$ W	5%
R795	315-0101-00			100 $\Omega$	$\frac{1}{4}$ W	5%
R797	321-0452-00			499 k $\Omega$	$\frac{1}{8}$ W	Prec 1%
R799	315-0472-00			4.7 k $\Omega$	$\frac{1}{4}$ W	5%
R802	315-0100-00			10 $\Omega$	$\frac{1}{4}$ W	5%
R803	315-0100-00			10 $\Omega$	$\frac{1}{4}$ W	5%
R805	323-0402-00			150 k $\Omega$	$\frac{1}{2}$ W	Prec 1%
R807	315-0101-00			100 $\Omega$	$\frac{1}{4}$ W	5%
R809	322-0210-00			1.5 k $\Omega$	$\frac{1}{4}$ W	Prec 1%
R811	*31 0-0632-00			30 k $\Omega$	3 W	WW 1%
R812	321-0210-00			1.5 k $\Omega$	$\frac{1}{8}$ W	Prec 1%
R813	311-0609-00			2 k $\Omega$ , Var		
R821	*31 0-0632-00			30 k $\Omega$	3 W	WW 1%
R823	311-0642-00			20 k $\Omega$ , Var		
R824	315-0682-00	B010100	B010111	6.8 k $\Omega$	$\frac{1}{4}$ W	5%
R824	315-0472-00	B010112		4.7 k $\Omega$	$\frac{1}{4}$ W	5%
R825	315-0822-00	B010100	B010111	8.2 k $\Omega$	$\frac{1}{4}$ W	5%
R825	315-0682-00	B010112		6.8 k $\Omega$	$\frac{1}{4}$ W	5%
R826	315-0133-00			13 k $\Omega$	$\frac{1}{4}$ W	5%
R830	321-0222-00			2 k $\Omega$	$\frac{1}{8}$ W	Prec 1%
R831	321-0222-00			2 k $\Omega$	$\frac{1}{8}$ W	Prec 1%
R833	315-0100-00			10 $\Omega$	$\frac{1}{4}$ W	5%
R836	321-0222-00			2 k $\Omega$	$\frac{1}{8}$ W	Prec 1%
R838	321-0222-00			2 k $\Omega$	$\frac{1}{8}$ W	Prec 1%
R901	301-0910-00			91 $\Omega$	$\frac{1}{2}$ W	5%
R903	315-0103-00			10 k $\Omega$	$\frac{1}{4}$ W	5%
R904	308-0229-00			4 k $\Omega$	5 W	WW 5%
R905	308-0275-00			200 $\Omega$	5 W	WW 5%
R906	321-0452-00			499 k $\Omega$	$\frac{1}{8}$ W	Prec 1%
R908	315-0224-00			220 k $\Omega$	$\frac{1}{4}$ W	5%
R910	315-0102-00			1 k $\Omega$	$\frac{1}{4}$ W	5%
R912	315-0103-00			10 k $\Omega$	$\frac{1}{4}$ W	5%
R914	321-0431-00			301 k $\Omega$	$\frac{1}{8}$ W	Prec 1%
R915	321-0318-00			20 k $\Omega$	$\frac{1}{8}$ W	Prec 1%
R924	315-0751-00			750 $\Omega$	$\frac{1}{4}$ W	5%
R925	315-0122-00			1.2 k $\Omega$	$\frac{1}{4}$ W	5%
R928	315-0103-00			10 k $\Omega$	$\frac{1}{4}$ W	5%
R930	321-0402-00			150 k $\Omega$	$\frac{1}{8}$ W	Prec 1%
R932	315-0562-00			5.6 k $\Omega$	$\frac{1}{4}$ W	5%
R934	321-0289-00			10 k $\Omega$	$\frac{1}{8}$ W	Prec 1%
R935	321-0289-00			10 k $\Omega$	$\frac{1}{8}$ W	Prec 1%
R940	311-0642-00			20 k $\Omega$ , Var		
R941	315-0131-00			130 $\Omega$	$\frac{1}{4}$ W	5%
R942	315-0432-00			4.3 k $\Omega$	$\frac{1}{4}$ W	5%



## Resistors (cont)

Ckt. No.	Tektronix Part No.	Serial/Model No. Eff	Disc	Description		
R954	321-0213-00			1.62 k $\Omega$	1/8 W	Prec 1%
R956	315-0222-00			2.2 k $\Omega$	1/4 W	5%
R958	315-0332-00			3.3 k $\Omega$	1/4 W	5%
R960	315-0123-00			12 k $\Omega$	1/4 W	5%
R962	315-0101-00			100 $\Omega$	1/4 W	5%
R964	321-0209-00			1.47 k $\Omega$	1/8 W	Prec 1%
R966	315-0302-00			3 k $\Omega$	1/4 W	5%
R967	321-0143-00			301 $\Omega$	1/8 W	Prec 1%
R968	311-0609-00			2 k $\Omega$ , Var		
R969	321-0283-00			8.66 k $\Omega$	1/8 W	Prec 1%
R972	315-0101-00			100 $\Omega$	1/4 W	5%
R974	307-0103-00			2.7 $\Omega$	1/4 W	5%
R976	315-0100-00			10 $\Omega$	1/4 W	5%
R982	315-0101-00			100 $\Omega$	1/4 W	5%
R984	315-0100-00			10 $\Omega$	1/4 W	5%
R990	315-0101-00			100 $\Omega$	1/4 W	5%
R992	315-0100-00			10 $\Omega$	1/4 W	5%
R1000	311-0606-00			500 k $\Omega$ , Var		
R1001	315-0105-00			1 M $\Omega$	1/4 W	5%
R1002	315-0103-00			10 k $\Omega$	1/4 W	5%
R1004	315-0102-00			1 k $\Omega$	1/4 W	5%
R1006	315-0101-00			100 $\Omega$	1/4 W	5%
R1007	315-0104-00			100 k $\Omega$	1/4 W	5%
R1009	315-0302-00			3 k $\Omega$	1/4 W	5%
R1010	315-0103-00			10 k $\Omega$	1/4 W	5%
R1012	315-0102-00			1 k $\Omega$	1/4 W	5%
R1014	301-0103-00			10 k $\Omega$	1/2 W	5%
R1021	303-0305-00			3 M $\Omega$	1 W	5%
R1022	303-0305-00			3 M $\Omega$	1 W	5%
R1023	303-0305-00			3 M $\Omega$	1 W	5%
R1024	303-0305-00			3 M $\Omega$	1 W	5%
R1025	303-0305-00			3 M $\Omega$	1 W	5%
R1026	303-0305-00	B010100	B129999	3 M $\Omega$	1 W	5%
R1026	303-0275-00	B130000		2.7 M $\Omega$	1 W	5%
R1027	303-0305-00	B010100	B129999	3 M $\Omega$	1 W	5%
R1027	303-0275-00	B130000		2.7 M $\Omega$	1 W	5%
R1028	311-0647-00			5 M $\Omega$ , Var		
R1029	303-0685-00	B010100	B129999	6.8 M $\Omega$	1 W	5%
R1029	303-0106-00	B130000		10 M $\Omega$	1 W	5%
R1030	303-0335-00	B010100	B129999	3.3 M $\Omega$	1 W	5%
R1030	303-0365-00	B130000		3.6 M $\Omega$	1 W	5%
R1032	311-0646-00			1 M $\Omega$ , Var		
R1033	311-0646-00			1 M $\Omega$ , Var		
R1035	311-0310-00			5 k $\Omega$ , Var		
R1038	311-0641-00			200 k $\Omega$ , Var		
R1040	323-0342-00			35.7 k $\Omega$	1/2 W	Prec 1%
R1042	323-0347-00			40.2 k $\Omega$	1/2 W	Prec 1%
R1050	315-0154-00			150 k $\Omega$	1/4 W	5%
R1051	315-0104-00			100 k $\Omega$	1/4 W	5%

## Resistors (cont)

Ckt. No.	Tektronix Part No.	Serial/Model No. Eff	Disc	Description		
R1053	315-0102-00		1 k $\Omega$	1/4 W		5%
R1055	315-0471-00		470 $\Omega$	1/4 W		5%
R1057	321-0239-00		3.01 k $\Omega$	1/8 W	Prec	1%
R1059	315-0101-00		100 $\Omega$	1/4 W		5%
R1062	321-0320-00		21 k $\Omega$	1/8 W	Prec	1%
R1063	311-0310-00		5 k $\Omega$ , Var			
R1065	321-0097-00		100 $\Omega$	1/8 W	Prec	1%
R1068	321-0250-00		3.92 k $\Omega$	1/8 W	Prec	1%
R1070	315-0332-00		3.3 k $\Omega$	1/4 W		5%
R1071	315-0100-00		10 $\Omega$	1/4 W		5%
R1073	321-0356-00		49.9 k $\Omega$	1/8 W	Prec	1%
R1075	311-0614-00		30 k $\Omega$ , Var			
R1080	315-0100-00		10 $\Omega$	1/4 W		5%
R1081	308-0429-00		22 k $\Omega$	3 W	WW	1%
R1082	321-0385-00		100 k $\Omega$	1/8 W	Prec	1%
R1084	315-0103-00		10 k $\Omega$	1/4 W		5%
R1086	315-0101-00		100 $\Omega$	1/4 W		5%
R1090	321-0318-00		20 k $\Omega$	1/8 W	Prec	1%
R1094	321-0298-00		12.4 k $\Omega$	1/8 W	Prec	1%
R1100	315-0562-00		5.6 k $\Omega$	1/4 W		5%
R1101	315-0472-00		4.7 k $\Omega$	1/4 W		5%
R1103	315-0102-00		1 k $\Omega$	1/4 W		5%
R1104	315-0104-00		100 k $\Omega$	1/4 W		5%
R1105	315-0913-00		91 k $\Omega$	1/4 W		5%
R1106 <sup>11</sup>	311-0645-00		50 k $\Omega$ , Var			
R1109	315-0101-00		100 $\Omega$	1/4 W		5%
R1111	315-0103-00		10 k $\Omega$	1/4 W		5%
R1112	315-0104-00		100 k $\Omega$	1/4 W		5%
R1114	315-0100-00		10 $\Omega$	1/4 W		5%
R1116	315-0473-00		47 k $\Omega$	1/4 W		5%
R1117	315-0102-00		1 k $\Omega$	1/4 W		5%
R1118	315-0122-00		1.2 k $\Omega$	1/4 W		5%
R1121	315-0510-00		51 $\Omega$	1/4 W		5%
R1122	315-0101-00		100 $\Omega$	1/4 W		5%
R1123	315-0332-00		3.3 k $\Omega$	1/4 W		5%
R1124	315-0162-00		1.6 k $\Omega$	1/4 W		5%
R1126	315-0163-00		16 k $\Omega$	1/4 W		5%
R1128	315-0101-00		100 $\Omega$	1/4 W		5%
R1129	317-0510-00		51 $\Omega$	1/8 W		5%
R1130	315-0473-00		47 k $\Omega$	1/4 W		5%
R1131	311-0607-00		10 k $\Omega$ , Var			
R1132	315-0333-00		33 k $\Omega$	1/4 W		5%
R1133	308-0293-00		4 k $\Omega$	3 W	WW	5%
R1134	315-0510-00		51 $\Omega$	1/4 W		5%
R1135	*308-0277-00		500 $\Omega$		WW	5%

<sup>11</sup>Furnished as a unit with SW1106.

## Resistors (cont)

Ckt. No.	Tektronix Part No.	Serial/Model No. Eff Disc	Description			
R1136	*308-0277-00		500 $\Omega$		WW	5%
R1137	315-0100-00		10 $\Omega$	1/4 W		5%
R1138	315-0510-00		51 $\Omega$	1/4 W		5%
R1140	311-0635-00		1 k $\Omega$ , Var			
R1141	315-0912-00		9.1 k $\Omega$	1/4 W		5%
R1142	321-0306-00		15 k $\Omega$	1/8 W	Prec	1%
R1143	321-0251-00		4.02 k $\Omega$	1/8 W	Prec	1%
R1144	321-0251-00		4.02 k $\Omega$	1/8 W	Prec	1%
R1145	321-0308-00		15.8 k $\Omega$	1/8 W	Prec	1%
R1147	317-0100-00		10 $\Omega$	1/8 W		5%
R1148	317-0101-00		100 $\Omega$	1/10 W		5%
R1149	317-0101-00		100 $\Omega$	1/10 W		5%
R1150	311-0635-00		1 k $\Omega$ , Var			
R1151	315-0912-00		9.1 k $\Omega$	1/4 W		5%
R1152	321-0340-00		34 k $\Omega$	1/8 W	Prec	1%
R1153	321-0251-00		4.02 k $\Omega$	1/8 W	Prec	1%
R1154	321-0251-00		4.02 k $\Omega$	1/8 W	Prec	1%
R1155	321-0339-00		33.2 k $\Omega$	1/8 W	Prec	1%
R1159	317-0510-00		51 $\Omega$	1/8 W		5%
R1162	321-0340-00		34 k $\Omega$	1/8 W	Prec	1%
R1163	321-0251-00		4.02 k $\Omega$	1/8 W	Prec	1%
R1164	321-0251-00		4.02 k $\Omega$	1/8 W	Prec	1%
R1165	321-0339-00		33.2 k $\Omega$	1/8 W	Prec	1%
R1169	317-0510-00		51 $\Omega$	1/8 W		5%
R1170	321-0385-00		100 k $\Omega$	1/8 W	Prec	1%
R1172	315-0125-00		1.2 M $\Omega$	1/4 W		5%
R1173	317-0122-00		1.2 k $\Omega$	1/8 W		5%
R1174	315-0155-00		1.5 M $\Omega$	1/4 W		5%
R1175	317-0122-00		1.2 k $\Omega$	1/8 W		5%
R1177	321-0277-00		7.5 k $\Omega$	1/8 W	Prec	1%
R1178	322-0402-00		150 k $\Omega$	1/4 W	Prec	1%
R1180	315-0103-00		10 k $\Omega$	1/4 W		5%
R1181	315-0101-00		100 $\Omega$	1/4 W		5%
R1182	311-0668-00		2 k $\Omega$ , Var			
R1183	315-0101-00		100 $\Omega$	1/4 W		5%
R1184	315-0103-00		10 k $\Omega$	1/4 W		5%
R1186	322-0402-00		150 k $\Omega$	1/4 W	Prec	1%
R1187	315-0471-00		470 $\Omega$	1/4 W		5%
R1189	315-0472-00		4.7 k $\Omega$	1/4 W		5%
R1190	315-0203-00		20 k $\Omega$	1/4 W		5%
R1191	315-0204-00		200 k $\Omega$	1/4 W		5%
R1192	315-0104-00		100 k $\Omega$	1/4 W		5%
R1193	315-0103-00		10 k $\Omega$	1/4 W		5%
R1195	315-0682-00		6.8 k $\Omega$	1/4 W		5%
R1196	315-0302-00		3 k $\Omega$	1/4 W		5%

### Resistors (cont)

Ckt. No.	Tektronix Part No.	Serial/Model No. Eff Disc	Description
R1197	315-0124-00	120 k $\Omega$	1/4 W 5%
R1198	315-0302-00	3 k $\Omega$	1/4 W 5%
R1199	315-0205-00	2 M $\Omega$	1/4 W 5%

### 1 dB Pad

R50	119-0091-00	Resistive "T" Network (includes J50, J51, J52) Attenuator Pad	
R60	119-0066-00		

### Switches

#### Wired or Unwired

SW70	260-0821-00	Lever	BAND
SW55 <sup>12</sup>	311-0662-00		
SW159	260-0642-00	Toggle	IF ATTEN 20 dB
SW164	260-0642-00	Toggle	IF ATTEN 16 dB
SW169	260-0642-00	Toggle	IF ATTEN 8 dB
SW174	260-0642-00	Toggle	IF ATTEN 4 dB
SW179	260-0642-00	Toggle	IF ATTEN 2 dB
SW184	260-0642-00	Toggle	IF ATTEN 1 dB
SW210	260-0866-00	Rotary	DISPERSION RANGE
SW250 <sup>13</sup>	Wired *262-0788-00	Rotary	DISPERSION
SW250 <sup>13</sup>	260-0759-01	Rotary	DISPERSION
SW365	260-0643-00	Toggle	
SW550 <sup>13</sup>		Rotary	COUPLED RESOLUTION
SW600	260-0820-00	Lever	VERTICAL DISPLAY
SW610	260-0643-00	Toggle	
SW700	260-0665-00	Lever	SOURCE
SW702 <sup>14</sup>	311-0640-00		
SW720	260-0664-00	Lever	SLOPE
SW785	Wired *262-0787-00	Rotary	TIME/DIV
SW785	260-0819-00	Rotary	TIME/DIV
SW786 <sup>15</sup>	311-0182-00		
SW900	260-0834-00	Toggle	POWER
SW902 <sup>16</sup>			
SW903 <sup>16</sup>			
SW1106 <sup>17</sup>	311-0645-00		
SW1190	260-0689-00	Push	LOCK CHECK

### Thermal Cut-Out

TK902	260-0677-00	Opens 158° $\pm$ 5°, closes 128° $\pm$ 10°
-------	-------------	--

<sup>12</sup>Furnished as a unit with R55.

<sup>13</sup>SW250 and SW550 furnished as a unit.

<sup>14</sup>Furnished as a unit with R702.

<sup>15</sup> Furnished as a unit with R786.

<sup>16</sup>See Mechanical Parts List. Line Voltage Selector Body.

<sup>17</sup> Furnished as a unit with R1106.

### Transformers

Ckt. No.	Tektronix Part No.	Serial/Model No. Eff                  Disc	Description
T14	*120-0340-00		5 turns, bifilar
T120	*120-0428-00		4 turns, bifilar
T124	*120-0325-00		5 turns, bifilar
T134	*120-0325-00		5 turns, bifilar
T148	*120-0325-00		5 turns, bifilar
T330	*120-0340-00		5 turns, bifilar
T331	*120-0340-00		5 turns, bifilar
T343	*120-0340-00		5 turns, bifilar
T347	*120-0340-00		5 turns, bifilar
T354	*120-0340-00		5 turns, bifilar
T363	*120-0340-00		5 turns, bifilar
T424	*120-0425-00		4 turns, primary
T434	*120-0426-00		2 windings
T454	*120-0356-00		3.5 MHz I.F.
T464	*120-0356-00		3.5 MHz I.F.
T640	*120-0179-00		8 turns, quintifilar
T900	*120-0455-00		L.V. Power
T1010	*120-0456-00		H.V. Power
T1128	*120-0194-00	B010100      B089999	4 turns, trifilar
T1128	*120-0194-01	B090000	4 turns, trifilar
T1140 } T1150 } T1160 }	Part of Circuit Board (*670-0504-00)		

### Electron Tubes

V40	154-0506-00	1641
V41	154-0506-00	1641
V42	*154-0510-00	Tek Spec
V1030	*154-0502-00	T491 0-7-1 CRT Standard Phosphor

### Cable Assemblies

W1	*175-0419-00		8 1/2 inch
W14	*175-0416-00		11 1/4 inch
W19	*175-0411-00		6 1/4 inch
W34	*175-0410-00		5 3/4 inch
W40	*175-0414-00		9 1/2 inch
W41	*175-0409-00		5 1/2 inch
W42	*175-0414-00		9 1/2 inch
W45	*175-0312-00	B010100      B069999	9 inch
W45	*175-0473-00	B070000	9 inch
W50	*175-0409-00	B010100	5 1/2 inch
W50	*175-0411-00	B010112	6 1/4 inch
W66	*175-0417-00	B010100      B089999	12 inch
W66	*175-0364-00	B090000	12 1/4 inch
W72	*175-0415-00	B010100      B089999	10 1/4 inch
W72	*175-0312-00	B090000	9 inch
W73	*175-0412-00	B010100      B089999	7 1/4 inch
W73	*175-0310-00	B090000	7 1/4 inch
W75	*175-0408-00		4 3/4 inch
W94	*175-0413-00		8 1/4 inch
W110	*175-0308-00		3 1/4 inch

**Cable Assemblies (cont)**

Ckt. No.	Tektronix Part No.	Serial/Model No. Eff	Disc	Description
W150	*175-0313-00			4 <sup>1</sup> / <sub>4</sub> inch
W200	*175-0358-00			2 <sup>13</sup> / <sub>16</sub> inch
W300	*175-0358-00	B010100	B059999	2 <sup>13</sup> / <sub>16</sub> inch
W300	*175-0413-00	B060000		8 <sup>1</sup> / <sub>4</sub> inch
W370 <sup>18</sup>				
W375 <sup>18</sup>				
W500	*175-0358-00			2 <sup>13</sup> / <sub>16</sub> inch
W1100	*175-0418-00			6 <sup>5</sup> / <sub>8</sub> inch
W1102	*175-0418-00			6 <sup>5</sup> / <sub>8</sub> inch
W1104	* 75-0418-00			6 <sup>5</sup> / <sub>8</sub> inch

**Crystals**

Y440	58-0024-00			70 MHz
Y501	58-0019-00			5 MHz
Y1104	58-0025-00			1 MHz

**Diplexer**

119-0100-00				Multiplexer, IF dual hybrid (includes J45, J46, J47)
-------------	--	--	--	--

**Mixers**

*610-0169-00	B010100	B119999		10-275 MHz Mixer Band A (includes D14 and D16)
*610-0169-02	B120000			10-275 MHz Mixer Band A (includes D14 and D16)
*119-0064-00				275-4200 MHz Mixer Band B (includes D64 and J69)
*119-0096-00				Mixer, Coaxial (includes D74)
*119-0097-00				Mixer, Crystal Waveguide (includes D82)
*119-0098-00				Mixer, Crystal Waveguide (includes D84)
*119-0099-00				Mixer, Crystal Waveguide (includes D86)

**Oscillator**

*119-0106-00				Oscillator, (includes V40, V41, V42, SW70, J40A, J40B, J41 A, J41 B, J42A, J42B, J71 , J72, J73, J75)
--------------	--	--	--	---

<sup>18</sup> Selected. See Mechanica I Parts List.

## FIGURE AND INDEX NUMBERS

Items in this section are referenced by figure and index numbers to the illustrations which appear on the pullout pages immediately following the Diagrams section of this instruction manual.

## INDENTATION SYSTEM

This mechanical parts list is indented to indicate item relationships. Following is an example of the indentation system used in the Description column.

*Assembly and/or Component*  
*Detail Part of Assembly and/or Component*  
*mounting hardware for Detail Part*  
*Parts of Detail Part*  
*mounting hardware for Parts of Detail Part*  
*mounting hardware for Assembly and/or Component*

Mounting hardware always appears in the same indentation as the item it mounts, while the detail parts are indented to the right. Indented items are part of, and included with, the next higher indentation.

Mounting hardware must be purchased separately, unless otherwise specified.

## ABBREVIATIONS AND SYMBOLS

For an explanation of the abbreviations and symbols used in this section, please refer to the page immediately preceding the Electrical Parts List in this instruction manual.

## INDEX OR MECHANICAL PARTS LIST ILLUSTRATIONS

(Located behind diagrams)

FIG. 1 FRONT

FIG. 2 REAR

FIG. 3 IF CHASSIS & PHASE LOCK ASSEMBLIES

FIG. 4 POWER CHASSIS

FIG. 5 TIME/DIV SWITCH & OSCILLATOR ASSEMBLIES

FIG. 6 CRT SHIELD ASSEMBLY

FIG. 7 CABINET ASSEMBLY & HANDLE

FIG. 8 491 ACCESSORIES



# SECTION 8

## MECHANICAL PARTS LIST

FIG. 1 FRONT

Fig. & Index No.	Tektronix Part No.	Serial/Model No.		Q † Y	Description
		Eff	Disc		
1-1	366-0392-00			1	KNOB, charcoal—INTENSITY
	- - - - -			-	knob includes:
	214-0949-00			1	SPRING
-2	366-0392-00			1	KNOB, charcoal—FOCUS
	- - - - -			-	knob includes:
	214-0949-00			1	SPRING
-3	366-0392-00			1	KNOB, charcoal—SCALE ILLUM
	- - - - -			-	knob includes:
	214-0949-00			1	SPRING
-4	366-0392-00			1	KNOB, charcoal—ASTIGMATISM
	- - - - -			-	knob includes:
	214-0949-00			1	SPRING
-5	366-0392-00			1	KNOB, charcoal—INTENSIFIER
	- - - - -			-	knob includes:
	214-0949-00			1	SPRING
-6	366-0392-00			1	KNOB, charcoal—POSITION (horizontal)
	- - - - -			-	knob includes:
	214-0949-00			1	SPRING
-7	366-0392-00			1	KNOB, charcoal—POSITION (vertical)
	- - - - -			-	knob includes:
	214-0949-00			1	SPRING
-8	366-0379-00			1	KNOB, charcoal—DISPERSION RANGE
	- - - - -			-	knob includes:
	213-0153-00			1	SCREW, set, 5-40 x 0.125 inch, HSS
-9	366-0373-00			1	KNOB, red—POWER OFF-ON
	- - - - -			-	knob includes:
	213-0153-00			1	SCREW, set, 5-40 x 0.125 inch, HSS
-10	366-0393-00	B010100	B139999	1	KNOB, charcoal—IF CENTER FREQ (fine)
	366-0494-00	B140000		1	KNOB, charcoal—IF CENTER FREQ (fine)
	- - - - -			-	knob includes:
	213-0153-00			1	SCREW, set, 5-40 x 0.125 inch, HSS
-11	- - - - -			3	RESISTOR, variable
	- - - - -			-	mounting hardware for each: (not included w/resistor)
-12	361-0143-00			1	SPACER, ring
-13	210-0940-00			1	WASHER, flat, 1/4 ID x 3/8 inch OD
-14	210-0583-00			1	NUT, hex., 1/4-32 x 5/16 inch
- 1 5	366-0393-00	B010100	B139999	1	KNOB, charcoal—TRIGGER (LEVEL)
	366-0494-00	B140000		1	KNOB, charcoal—TRIGGER (LEVEL)
	- - - - -			-	knob includes:
	213-0153-00			1	SCREW, set, 5-40 x 0.125 inch, HSS
- 1 6	- - - - -			1	RESISTOR, variable
	- - - - -			-	mounting hardware: (not included w/resistor)
- 1 7	361-0143-00			1	SPACER, ring
- 1 8	210-0583-00			1	NUT, hex., 1/4-32 x 5/16 inch
- 1 9	366-0215-02			1	KNOB, charcoal, lever—TRIGGER (SLOPE)
- 2 0	260-0664-00			1	SWITCH, lever—TRIGGER (SLOPE)
	- - - - -			-	mounting hardware: (not included w/switch)
- 2 1	220-0413-00			2	NUT, hex., 4-40 x 0.562 inch long

FIG. 1 FRONT (cont)

Fig. & Index No.	Tektronix Part No.	Serial/Model Eff	No. Disc	Q					Description	
				f	1	2	3	4		5
1-22	366-0215-02			1						KNOB, charcoal lever—TRIGGER (SOURCE)
-23	260-0665-00			1						SWITCH, lever—TRIGGER (SOURCE)
-24	220-0413-00			2						mounting hardware: (not included w/switch) NUT, hex., 4-40 x 0.562 inch long
-25	366-0393-00	B010100	B139999	1						KNOB, charcoal—GAIN
	366-0494-00	B140000		1						KNOB, charcoal—GAIN
	213-0153-00			-						knob includes:
	213-0153-00			1						SCREW, set, 5-40 x 0.125 inch, HSS
-26	366-0393-00	B010100	B139999	1						KNOB, charcoal—MIXER PEAKING
	366-0494-00	B140000		1						KNOB, charcoal—MIXER PEAKING
	213-0153-00			-						knob includes:
	213-0153-00			1						SCREW, set, 5-40 x 0.125 inch, HSS
-27	366-0413-00	B010100	B139999	1						KNOB, charcoal—FINE RF CENTER FREQ
	366-0495-00	B140000		1						KNOB, charcoal—FINE RF CENTER FREQ
	213-0153-00			-						knob includes:
	213-0153-00			1						SCREW, set, 5-40 x 0.125 inch, HSS
-28	366-0393-00	B010100	B139999	1						KNOB, charcoal—PHASE LOCK (INT REF FREQ)
	366-0494-00	B140000		1						KNOB, charcoal—PHASE LOCK (INT REF FREQ)
	213-0153-00			-						knob includes:
	213-0153-00			1						SCREW, set, 5-40 x 0.125 inch, HSS
-29	366-0407-00	B010100	B139999	1						KNOB, red—VARIABLE CAL
	366-0493-00	B140000		1						KNOB, red—VARIABLE CAL
	213-0153-00			-						knob includes:
	213-0153-00			1						SCREW, set, 5-40 x 0.125 inch, HSS
-30	366-0398-00	B010100	B139999	1						KNOB, charcoal—TIME/DIV
	366-1001-00	B140000		1						KNOB, charcoal—TIME/DIV
	213-0153-00			-						knob includes:
	213-0153-00			1						SCREW, set, 5-40 x 0.125 inch, HSS
-31	366-0215-02			1						KNOB, charcoal, lever—VERTICAL DISPLAY
-32	260-0820-00			1						SWITCH, lever—VERTICAL DISPLAY
-33	220-0413-00			2						mounting hardware: (not included w/switch) NUT, hex., 4-40 x 0.562 inch long
-34	260-0643-00			1						SWITCH, toggle—VIDEO FILTER
-35	210-0046-00			1						mounting hardware: (not included w/switch) LOCKWASHER, internal, 1/4 ID x 0.400 inch OD
-36	210-0562-00			2						NUT, hex., 1/4-40 x 5/16 inch
-37	331-0168-00	B010100	B019999	1						DIAL, w/o brake—IF CENTER FREQ
	331-0168-01	B020000		1						DIAL, w/brake—IF CENTER FREQ
-38	366-0215-02			1						KNOB, charcoal, lever—RF CENTER FREQ
-39	366-0405-00	B010100	B139999	1						KNOB, charcoal—COUPLED RESOLUTION
	366-1033-00	B140000		1						KNOB, charcoal—COUPLED RESOLUTION
	213-0153-00			-						knob includes:
	213-0153-00			1						SCREW, set, 5-40 x 0.125 inch, HSS
-40	366-0406-00			1						KNOB, charcoal—DISPERSION
	213-0153-00			-						knob includes:
	213-0153-00			1						SCREW, set, 5-40 x 0.125 inch, HSS
-41	262-0788-00			1						SWITCH, wired—COUPLED RESOLUTION-DISPERSION
	260-0759-01			1						switch includes: SWITCH, unwired
-42	210-0978-00			1						mounting hardware: (not included w/switch) WASHER, flat, 3/8 ID x 1/2 inch OD
-43	210-0590-00			1						NUT, hex., 3/8-32 x 7/16 inch

FIG. 1 FRONT (cont)

Fig. & Index	Tektronix Part No.	Serial/Model No. Eff	No. Disc	Q					Description	
				†	Y	1	2	3		4
1-44	199-0066-00			1						ATTENUATOR, pad
	-----									mounting hardware: (not included w/attenuator)
	210-1010-00			1						WASHER, flat, 0.643 ID x 0.875 inch OD
-45	119-0064-00			1						MIXER, w/crystal
-46	103-0057-00			1						ADAPTER, connector
	136-0246-00			1						ASSEMBLY, receptacle, locking, coaxial, mixer (BAND "C")
	-----									assembly includes:
-47	220-0467-00			1						NUT, sleeve, 0.875-20 x 1 x 1 inch long
-48	210-0047-00			1						LOCKWASHER, internal, 0.880 ID x 1.110 inches OD
-49	175-0420-00			1						ASSEMBLY, cable, 4.375 inches (ASSEMBLY to J46)
-50	354-0303-00			1						RING, retaining
-51	354-0301-01			1						RING, locking
-52	205-0077-00			1						SHELL
-53	214-0862-00			2						SPRING, locking
-54	214-0861-00			1						SPRING, compression
-55	166-0005-00			1						TUBE, spacer
-56	214-0505-00			1						CAM, switch actuator
	-----			-						mounting hardware: (not included w/cam)
-57	213-0022-00			1						SCREW, set, 4-40 x 3/16 inch, HSS
-58	358-0301-01			4						BUSHING, plastic
-59	358-0210-00			1						BUSHING, plastic, 1 1/32 diameter x 5/32 inch long
-60	376-0067-00			1						COUPLING
	-----			-						coupling includes:
	213-0048-00			2						SCREW, set, 4-40 x 1/8 inch, HSS
-61	384-0419-00			1						SHAFT, extension
-62	384-0658-00			1						SHAFT, extension
-63	136-0223-00			1						SOCKET, light w/hardware
	-----			-						mounting hardware: (not included w/socket)
	210-0940-00			1						WASHER, flat, 1/4 ID x 3/8 inch, OD
-64	380-0110-01			1						HOUSING, gear drive
	-----			-						mounting hardware: (not included w/housing)
-65	211-0507-00			2						SCREW, 6-32 x 5/16 inch, PHS
-66	214-0911-00			2						GEAR
	-----									mounting hardware for each: (not included w/gear)
-67	213-0075-00			2						SCREW, set, 4-40 x 3/32 inch, HSS
-68	354-0251-00	B0101 00	B069999X	1						RING, coupling
	-----			-						mounting hardware: (not included w/ring)
-69	213-0048-00	B010100	B069999X	2						SCREW, set, 4-40 x 1/4 inch, HSS
-70	214-0765-00	B0101 00	B069999	1						ACTUATOR, switch
	214-0765-01	B070000		1						ASSEMBLY, actuator, switch
	-----			-						assembly includes:
	166-0447-00			1						SLEEVE, 0.125 ID x 0.161 OD x 0.375 inch long
	214-0775-00			1						actuator, switch
	354-0251-00			1						RING, coupling
	213-0048-00			2						SCREW, set, 4-40 x 1/8 inch HSS

FIG. 1 FRONT (cont)

Fig. & Index No.	Tektronix Part No.	Serial/Model Eff	No. Disc	Q					Description
				†	1	2	3	4	
				Y					
1-71	376-0068-00			1					COUPLING
	- - - - -								coupling includes:
	213-0048-00			2					SCREW, set, 4-40 x 1/8 inch, HSS
-72	384-0420-00			1					SHAFT, extension
-73	384-0658-00			1					SHAFT, extension
-74	200-0021-00			2					COVER, plastic, black, 1 5/8 inches
-75	348-0031-00			2					GROMMET, plastic, 1/4 inch
-76	407-0315-01			1					BRACKET, protector bar, right
	- - - - -								mounting hardware: (not included w/bracket)
-77	211-0507-00			2					SCREW, 6-32 x 5/16 inch, PHS
-78	407-0315-02			1					BRACKET, protector bar, left
	- - - - -								mounting hardware: (not included w/bracket)
-79	211-0507-00			2					SCREW, 6-32 x 5/16 inch, PHS
-80	384-0631-00			2					ROD, spacer
	- - - - -								mounting hardware for each: (not included w/rod)
-81	212-0068-00			2					SCREW, 8-32 x 5/16 inch, THS
-82	426-0259-01			2					FRAME, rail
	- - - - -								mounting hardware for each: (not included w/frame)
-83	212-0506-00			4					SCREW, 10-32 x 3/8 inch, 100° csk, FHS
-84	348-0117-00			2					SHIELDING GASKET
-85	348-0117-01			2					SHIELDING GASKET
-86	214-0654-00	B010100	B149999	1					SPRING, grounding
	348-0155-00	B1 50000		1					SHIELDING GASKET
-87	378-0571-00			1					FILTER, mesh
-88	366-0394-00	B0101 00	B089999	1					KNOB, charcoal—RF CENTER FREQUENCY
	- - - - -								knob includes:
	213-01 53-00	B010100	B089999	1					SCREW, set, 5-40 x 0.125 inch, HSS
	366-0402-00	B090000		1					KNOB, charcoal, crank—RF CENTER FREQUENCY
	- - - - -								knob includes:
	21 3-01 53-00	B090000		2					SCREW, set, 5-40 x 0.125 inch, HSS
-89	337-0925-01			1					SHIELDING, GASKET
-90	175-0419-00			1					ASSEMBLY, cable, 8 inches (J1 to J10)
	- - - - -								assembly includes:
	131-0390-00			1					CONNECTOR, coaxial, 1 contact, BNC, w/hardware
-91	426-0318-01			1					FRAME, front subpanel
	- - - - -								frame includes:
-92	213-0020-00			7					SCREW, set, 6-32 x 1/8 inch, HSS
-93	333-0960-01			1					PANEL, front
	- - - - -								mounting hardware: (not included w/panel)
	213-0055-01			1					SCREW, thread forming, 2-32 x 3/16 inch, PHS (not shown)
-94	388-0817-00			1					BOARD, circuit, 1 terminal
	- - - - -								mounting hardware: (not included w/board)
-95	211-0116-00			1					SCREW, sems, 4-40 x 5/16 inch, PHB
-96	388-0815-00			1					BOARD, circuit, 3 terminal
	- - - - -								mounting hardware: (not included w/board)
-97	211-0116-00			2					SCREW, sems, 4-40 x 5/16 inch, PHB

FIG. 2 REAR

Fig. & Index No.	Tektronix Part No.	Serial/Model No.		Q † Y	Description
		Eff	Disc		
2 - 9	8 175-0415-00	B0101 00	B090409	1	ASSEMBLY, cable, 10 inches (J69 to J72)
	175-0312-00	B09041 0		1	ASSEMBLY, cable, 10 inches (J69 to J72)
- 9	9 175-0417-00	B010100	B090409	1	ASSEMBLY, cable, 12 inches (J65 to J41 A)
	175-0364-00	B09041 0		1	ASSEMBLY, cable, 12 inches (J65 to J41 A)
-100	119-0096-00			1	MIXER
-101	260-0866-00			1	SWITCH, unwired—DISPERSION RANGE
	- - - - -				mounting hardware: (not included w/switch)
	213-0022-00			1	SCREW, set, 4-40 x 3/16 inch, HSS (not shown)
- 1	352-0031 -00			1	HOLDER, fuse, single, 3AG
	- - - - -				mounting hardware: (not included w/holder)
-2	211-0504-00			1	SCREW, 6-32 x 1/4 inch, PHS
-3	119-0095-00	B010100	B059999	1	FILTER, RFI
	119-0095-03	B060000		1	FILTER, RFI
	- - - - -				mounting hardware: (not included w/filter)
-4	211-0507-00			2	SCREW, 6-32 x 5/16 inch, PHS
- 5	210-0457-00			2	NUT, keps, 6-32 x 5/16 inch
-6	131-0106-01			3	CONNECTOR, coaxial, 1 contact, BNC, w/hardware
	- - - - -				mounting hardware for each: (not included w/connector)
- 7	210-0255-00			1	LUG, solder, 3/8 inch
-8	131-0373-00			2	CONNECTOR, terminal standoff
	- - - - -				mounting hardware for each: (not included w/connector)
	210-0001-00			1	LOCKWASHER, internal, #2 (not shown)
- 9	210-0405-00			1	NUT, hex., 2-56 x 3/16 inch
-10	- - - - -			1	CAPACITOR
	- - - - -				mounting hardware: (not included w/capacitor)
-11	407-0297-00			1	BRACKET
-12	210-0586-00			2	NUT, keps, 4-40 x 1/4 inch
	129-0053-00			1	ASSEMBLY, binding post
	- - - - -				assembly includes:
-13	355-0507-00			1	STEM
-14	200-0103-00			1	CAP
	- - - - -				mounting hardware: (not included w/assembly)
-15	210-0046-00			1	LOCKWASHER, internal, 1/4 ID x 15/32 inch OD
-16	210-0455-00			1	NUT, hex., 1/4-28 x 3/8 x 3/32 inch
-17	- - - - -			1	RESISTOR, variable
	- - - - -				mounting hardware: (not included w/resistor)
-18	210-0046-00			1	LOCKWASHER, internal, 1/4 ID x 0.400 inch OD
-19	210-0583-00			1	NUT, hex., 1/4-32 x 5/16 inch

FIG. 2 REAR (cont)

Fig. & Index No.	Tektronix Part No.	Serial/Model Eff	No. Disc	Q † y						Description
					1	2	3	4	5	
2-20	407-0272-00			1						BRACKET mounting hardware: (not included w/bracket)
-21	211-0512-00			1						SCREW, 6-32 x 1/2 inch, 100° csk, FHS
-22	210-0457-00			1						NUT, keps, 6-32 x 5/64 inch
-23	211-0507-00			2						SCREW, 6-32 x 5/16 inch, PHS
-24	670-0506-00			1						ASSEMBLY, circuit board—VERTICAL AMPLIFIER & BLANKING assembly includes:
	388-0800-00			1						BOARD, circuit
-25	214-0506-00			26						PIN, connector, male
-26	136-0183-00			3						SOCKET, transistor, 3 pin
-27	136-0220-00			8						SOCKET, transistor, 3 pin mounting hardware: (not included w/assembly)
-28	211-0116-00			4						SCREW, sems, 4-40 x 5/16 inch, PHB
-29	200-0021-00			1						COVER, plastic, black, 1 5/8 inches
-30	204-0279-00			1						ASSEMBLY, line voltage selector mounting hardware: (not included w/body)
-31	210-0006-00			2						LOCKWASHER, internal, #6
-32	210-0407-00			2						NUT, hex., 6-32 x 1/4 inch
-33	200-0764-00			1						COVER, line voltage selector cover includes:
-34	352-0102-00			2						HOLDER, fuse, plastic mounting hardware for each: (not included w/holder)
-35	213-0088-00			2						SCREW, thread cutting, #4 x 1/4 inch, PHS
-36	337-0901-00			1						SHIELDING GASKET
-37	386-1115-00			1						PLATE, rear
-38	337-0871-00			1						SHIELD mounting hardware: (not included w/shield)
-39	211-0512-00			2						SCREW, 6-32 x 1/2 inch, 100° csk, FHS
-40	210-0457-00			2						NUT, keps, 6-32 x 5/16 inch
	210-0586-00			4						NUT, keps, 4-40 x 1/4 inch, (not shown)
	621-0428-00			1						ASSEMBLY, high voltage assembly includes:
-41	200-0607-00			1						COVER
-42	202-0135-00			1						BOX
-43	670-0508-00			1						ASSEMBLY, circuit board, 175 V supply assembly includes:
	388-0807-00			1						BOARD, circuit
-44	214-0806-00			1						INSULATOR, plastic
-45	670-0509-00			1						ASSEMBLY, circuit board, CRT HV divider assembly includes:
	388-0808-00			1						BOARD, circuit
-46	670-0510-00			1						ASSEMBLY, circuit board, CRT HV supply assembly includes:
	388-0809-00			1						BOARD, circuit

FIG. 2 REAR (cont)

Fig. & Index No.	Tektronix Part No.	Serial/Model No.		Q f Y	1	2	3	4	5	Description
		Eff	Disc							
2 - 4 7	179-1097-00	B0101 00	B019999	1						CABLE HARNESS, high voltage & CRT
	179-1194-00	B020000	B119999	1						CABLE HARNESS, high voltage & CRT
	179-1194-01	B120000		1						CABLE HARNESS, high voltage & CRT cable harness includes:
- 4 8	131-0371 -00			7						CONNECTOR, single contact
- 4 9	136-0243-00	B010100	B119999	1						SOCKET, CRT, 14 pin
	136-0243-01	B120000		1						SOCKET, CRT, 14 pin socket includes:
	136-0202-01			1						SOCKET, CRT, 14 pin
	200-0616-00	B0101 00	B119999X	1						COVER, CRT socket mounting hardware: (not included w/assembly)
- 5 0	211-0544-00			2						SCREW, 6-32 x 3/4 inch, THS
- 5 1	129-0104-00			2						POST, 0.25 diameter x 1.59 inches
- 5 2	211-0507-00			2						SCREW, 6-32 x 5/16 inch, PHS
- 5 3	200-0616-00	XB1 20000		1						COVER, CRT socket
- 5 4	426-0319-01			1						FRAME, rear, lower
- 5 5	426-0320-00			1						FRAME, rear, upper mounting hardware: (not included w/frame)
- 5 6	212-0506-00			2						SCREW, 10-32 x 3/8 inch, 100° csk, FHS
- 5 7	179-1096-00	B010100	B019999X	1						CABLE HARNESS, power #2 cable harness includes:
- 5 8	214-0768-00			8						CONTACT
- 5 9	214-0776-00			1						SHIELDING GASKET

FIG. 3 IF CHASSIS & PHASE LOCK ASSEMBLIES

Fig. & Index No.	Tektronix Part No.	Serial/Model No. Eff Disc	Q † Y	1 2 3 4 5					Description
				1	2	3	4	5	
3-	610-0175-00		1						ASSEMBLY, IF CHASSIS
- -	610-0173-00		1						assembly includes: ASSEMBLY, IF ATTENUATOR dB
-1	260-0642-00		-						assembly includes:
-2	337-0799-00		6						SWITCH, toggle—IF ATTENUATOR dB
- -	610-0174-00		1						SHIELD, switch
-3	131-0372-00		4						ASSEMBLY, BANDPASS FILTER
-4	210-0206-00		2						assembly includes:
- 5			6						CONNECTOR, coaxial, 1 contact, w/hardware
-6	214-0456-00		1						LUG, solder, SE #1 0, long
-7	124-0181-00		2						CAPACITOR
- 8	337-0802-00		1						mounting hardware for each: (not included w/capacitor)
-9	441-0667-00		1						FASTENER, plastic
-10	211-0065-00		8						STRIP, terminal
-11	131-0182-00		2						SHIELD, filter
	358-0135-00		1						CHASSIS
-12	131-0372-00		9						mounting, hardware: (not included w/assembly)
-13			1						SCREW, 4-40 x 3/16 inch, PHS
-14	210-0812-00		1						CONNECTOR, terminal feed thru
-15	210-0813-00		1						mounting hardware for each: (not included w/connector)
-16			6						BUSHING, plastic
-17	131-0373-00		21						CONNECTOR, coaxial, 1 contact, w/hardware
-18	210-0259-00		1						CAPACITOR, w/hardware
-19	210-0405-00		1						mounting hardware for each: (not included w/capacitor)
-20	136-0153-00		1						WASHER, fiber, #1 0
-21	211-0022-00		1						WASHER, fiber, #10, shouldered
-22	210-0405-00		1						CAPACITOR, w/hardware
-23	131-0373-00		9						CONNECTOR, terminal standoff
-24	210-0001-00		1						mounting hardware for each: (not included w/connector)
-25	210-0405-00		1						LUG, solder, #2
			1						NUT, hex., 4-40 x 3/16 inch
			1						SOCKET, crystal, 2 pin, w/clamp
			1						mounting hardware: (not included w/socket)
			1						SCREW, 2-56 x 3/16 inch, RHS
			1						NUT, hex., 2-56 x 3/16 inch
			1						LOCKWASHER, internal, #2 (not shown)
			1						CONNECTOR, terminal standoff
			1						mounting hardware for each: (not included w/connector)
			1						LOCKWASHER, internal, #2
			1						NUT, hex., 4-40 x 3/16 inch



FIG. 3 IF CHASSIS & PHASE LOCK ASSEMBLIES (cont)

Fig. & Index No.	Tektronix Part No.	Serial/Model Eff	No. Disc	Q † y	1 2 3 4 5					Description
					1	2	3	4	5	
3-26	136-0217-00			9						SOCKET, transistor, 4 pin
	- - - - -			-						mounting hardware for each: (not included w/socket)
-27	354-0285-00			1						HOLDER, socket
-28	136-0218-00			6						SOCKET, transistor, 3 pin
	- - - - -			-						mounting hardware for each: (not included w/socket)
-29	354-0285-00			1						HOLDER, socket
-30	260-0643-00			1						SWITCH, toggle—DISPERSION RANGE
	- - - - -			-						mounting hardware: (not included w/switch)
	214-0695-00			1						WASHER, key, 0.255 ID x 0.375 inch OD
	210-0562-00			1						NUT, hex., 1/4-40 x 5/16 inch
-31	426-0121-00			2						MOUNT, toroid, plastic
	- - - - -			-						mounting hardware for each: (not included w/mount)
-32	361-0007-00			1						SPACER, plastic, 0.188 inch long
-33	- - - - -			1						COIL
	- - - - -			-						mounting hardware: (not included w/coil)
-34	385-0150-00			1						ROD, spacer, 3/8 x 5/8 inch
-35	210-0004-00			1						LOCKWASHER, internal, #4
-36	211-0008-00			1						SCREW, 4-40 x 1/4 inch, PHS
-37	337-0801-00			1						SHIELD
-38	337-0803-01			1						SHIELD
-39	388-0683-00			1						BOARD, connector
	- - - - -									board includes:
-40	214-0506-00			16						PIN, connector, male
	- - - - -			-						mounting hardware: (not included w/board)
-41	213-0141-00			2						SCREW, thread forming, 4-40 x 1/4 inch, PHS
-42	670-0100-00			1						ASSEMBLY, circuit board
	- - - - -			-						assembly includes:
	388-0684-00			1						BOARD, circuit
-43	179-1046-00			1						CABLE HARNESS, sweeper
-44	441-0666-00			1						CHASSIS
	- - - - -			-						mounting hardware: (not included w/chassis)
-45	211-0065-00			16						SCREW, 4-40 x 3/16 inch, PHS
-46	386-1032-00			1						PLATE, chassis cover
	- - - - -			-						mounting hardware: (not included w/plate)
-47	211-0065-00			16						SCREW, 4-40 x 3/16 inch, PHS
-48	211-0105-00			5						SCREW, 4-40 x 3/16 inch, PHS
-49	136-0208-00	B0101 00	B159999	1						SOCKET, crystal
	136-0325-00	B1 60000		1						SOCKET, crystal
	352-0130-01	B1 60000		1						HOLDER, crystal
-50	131-0372-00			2						CONNECTOR, coaxial, 1 contact, w/hardware
	- - - - -			-						mounting hardware for each: (not included w/connector)
-51	210-0812-00			1						WASHER, fiber, #10
-52	210-0206-00			1						LUG, solder, #10
-53	210-0813-00			1						WASHER, fiber, #10, shouldered

FIG. 3 IF CHASSIS & PHASE LOCK ASSEMBLIES (cont)

Fig. & Index No.	Tektronix Part No.	Serial/Model No. Eff	No. Disc	Q					Description
				t	y	1	2	3	
3-54	210-0259-00			6					LUG, solder, #2 mounting hardware for each: (not included w/lug)
-55	213-0055-00			1					SCREW, 2-56 x 3/16 inch, PHS
-56	175-0308-00			1					ASSEMBLY, cable, 2 inches (J120 to J109)
	175-0313-00			1					ASSEMBLY, cable, 3 inches (J147 to J151)
	175-0384-00			1					<sup>1</sup> ASSEMBLY, cable, black band
	175-0384-01			1					<sup>1</sup> ASSEMBLY, cable, brown band
	175-0384-02			1					<sup>1</sup> ASSEMBLY, cable, red band
	175-0384-03			1					<sup>1</sup> ASSEMBLY, cable, orange band
	175-0384-04			1					<sup>1</sup> ASSEMBLY, cable, yellow band
	175-0358-00			1					ASSEMBLY, cable, 1 7/16 inches (J363 to J148)
	175-0358-00			1					ASSEMBLY, cable, 1 7/16 inches (J501 to J470)
	175-0358-00	B0101 00	B059999	1					ASSEMBLY, cable, 1 7/16 inches (J188 to J401)
	175-0413-00	B060000		1					ASSEMBLY, cable, 8.250 inches (J188 to J401)
	- - - - -								mounting hardware: (not included w/assembly)
	211-0507-00			2					SCREW, 6-32 x 5/16 inch, PHS (not shown)
	210-0562-00			6					NUT, hex., 1/4-40 x 5/16 inch (not shown)
	210-0940-00			6					WASHER, flat, 1/4 ID x 3/8 inch OD
-57	175-0413-00			1					ASSEMBLY, cable 8 inches (J100 to J94)
	644-0415-00			1					ASSEMBLY, PHASE LOCK
	- - - - -			-					assembly includes:
-58	670-0504-00			1					ASSEMBLY, circuit board—PHASE LOCK
	- - - - -			-					assembly includes:
	388-0798-00			1					BOARD, circuit
	132-0119-00			3					DISK, plastic (not shown)
-59	136-0183-00			1					SOCKET, transistor, 3 pin
-60	136-0220-00			7					SOCKET, transistor, 3 pin
-61	344-0064-00			16					CLIP, diode
-62	352-0041-00			11					HOLDER, diode
-63	352-0096-00			1					HOLDER, crystal
-64	131-0391-00			3					CONNECTOR, coaxial, 1 contact
	- - - - -			-					mounting hardware: (not included w/assembly)
-65	211-0116-00			7					SCREW, sems, 4-40 x 5/16 inch, PHB
-66	131-0352-01			1					CONNECTOR, coaxial, 1 contact, BNC, w/hardware
-67	- - - - -			1					RESISTOR, variable
	- - - - -			-					mounting hardware: (not included w/resistor)
-68	210-0011-00			1					LOCKWASHER, internal, 1/4 ID x 15/32 inch OD
-69	210-0905-00			1					WASHER, flat, 0.265 ID x 7/16 inch OD
-70	210-0583-00			1					NUT, hex., 1/4-32 x 5/16 inch
-71	260-0689-00			1					SWITCH, push button—LOCK CHECK
	- - - - -								mounting hardware: (not included w/switch)
-72	210-0223-00			1					LUG, solder, 1/4 ID x 7/16 inch OD, SE
-73	210-0905-00			1					WASHER, flat, 0.265 ID x 7/16 inch OD
-74	210-0583-00			1					NUT, hex., 1/4-32 x 5/16 inch

<sup>1</sup>This is a specially selected cable assembly connected from J370 to J373 and J376 to J379. Replace only with part bearing the same color band as the original part in your instrument.

FIG. 3 IF CHASSIS & PHASE LOCK ASSEMBLIES (cont)

Fig. & Index No.	Tektronix Part No.	Serial/Model No. Eff	No. Disc	Q					Description
				f	1	2	3	4	
3-75	- - - - -			1					RESISTOR, variable
	- - - - -			-					mounting hardware: (not included w/resistor)
	210-1042-00			1					LOCKWASHER, internal, 0.285 ID x 0.50 inch OD (not shown)
-76	210-0583-00			1					NUT, hex., 1/4-32 x 5/16 inch
-77	388-0688-00			1					BOARD, circuit
	- - - - -			-					board includes:
-78	214-0507-00			10					PIN, connector
	- - - - -			-					mounting hardware: (not included w/board)
-79	211-0116-00			2					SCREW, sems, 4-40 x 5/16 inch, PHB
-80	348-0056-00			1					GROMMET, plastic, 0.406 inch diameter
-81	337-0870-00			1					SHIELD
-82	179-1098-00			1					CABLE HARNESS, phase lock
-83	175-0418-00			1					ASSEMBLY, cable, 6 1/4 inches (J1 140)
	- - - - -			-					assembly includes:
-84	131-0450-00			1					CONNECTOR, coaxial, 1 contact, w/hardware
-85	175-0418-00			1					ASSEMBLY, cable, 6 1/4 inches (J1 150)
	- - - - -			-					assembly includes:
-86	131-0450-00			1					CONNECTOR, coaxial, 1 contact, w/hardware
-87	175-0418-00			1					ASSEMBLY, cable, 6 1/4 inches (J1 160)
	- - - - -			-					assembly includes:
-88	131-0450-00			1					CONNECTOR, coaxial, 1 contact, w/hardware
	- - - - -			-					mounting hardware: (not included w/assembly)
	210-0940-00			3					WASHER, flat, 1/4 ID x 3/8 inch OD
	210-0583-00			3					NUT, hex., 1/4-32 x 5/16 inch
	211-0504-00			1					SCREW, 6-32 x 1/4 inch, PHS
-89	343-0081-00			1					CLAMP, cable, plastic, 3/16 inch
	- - - - -			-					mounting hardware: (not included w/clamp)
-90	211-0510-00			1					SCREW, 6-32 x 3/8 inch, PHS
-91	210-0803-00			1					WASHER, flat, 0.150 x 3/8 inch OD
	210-0457-00			1					NUT, keps, 6-32 x 5/16 inch
-92	119-0100-00			1					MULTIPLEXER
	- - - - -			-					mounting hardware: (not included w/multiplexer)
-93	210-0906-00	B010100	B100000X	2					WASHER, fiber, 1/8 inch ID x 13/64 inch OD
-94	210-1008-00			2					WASHER, flat, 0.090 ID x 0.188 inch OD
-95	211-0001-00			2					SCREW, 2-56 x 1/4 inch, RHS
	210-0001-00			2					LOCKWASHER, internal, #2 (not shown)
-96	136-0218-00			2					SOCKET, transistor, 3 pin
	- - - - -			-					mounting hardware for each: (not included w/socket)
-97	354-0285-00			1					HOLDER, socket
-98	344-0002-00			2					CLIP
	- - - - -			-					mounting hardware for each: (not included w/clip)
-99	213-0138-00			1					SCREW, sheet metal, #4 3/16 inch, PHS
-100	210-0201-00			1					LUG, solder, SE #4
	- - - - -			-					mounting hardware: (not included w/lug)
-101	213-0138-00			1					SCREW, sheet metal, #4 x 3/16 inch, PHS

FIG. 3 IF CHASSIS & PHASE LOCK ASSEMBLIES (cont)

Fig. & Index No.	Tektronix Part No.	Serial/Model No.		Q † y	Description	
		Eff	Disc			1
3-102	337-0879-00			1	SHIELD mounting hardware: (not included w/shield)	
-103	213-0138-00			5	SCREW, sheet metal, #4 x 3/16 inch, PHS	
--	610-0169-00	B010100	B119999		ASSEMBLY, 10-275 MHz MIXER "A"	
	610-0169-02	B1 20000			ASSEMBLY, 10-275 MHz MIXER "A"	
	- - - - -			-	assembly includes:	
-104	131-0372-00			3	CONNECTOR, coaxial, 1 contact, w/hardware	
-105	131-0373-00			4	CONNECTOR, terminal standoff	
	- - - - -				mounting hardware for each: (not included w/connector)	
	210-0001-00			1	LOCKWASHER, internal, #2 (not shown)	
	210-0405-00			1	NUT, hex., 4-40 x 3/16 inch (not shown)	
-106	- - - - -			2	CAPACITOR, w/hardware	
-107	441-0671-00	B010100	B119999	1	CHASSIS	
	441-0671-03	B1 20000		1	CHASSIS	
	- - - - -			-	mounting hardware: (not included w/chassis)	
-108	210-0599-00			4	NUT, sleeve. 4-40 x 0.391 inch long	
-109	380-0097-00			1	HOUSING	
-110	386-1037-00			1	PLATE, shield bottom	
	- - - - -				mounting hardware: (not included w/plate)	
-111	211-0106-00			4	SCREW, 4-40 x 5/8 inch, 100° csk, FHS	
	- - - - -				mounting hardware: (not included w/assembly)	
-112	213-0138-00			2	SCREW, sheet metal, #4 x 3/16 inch, PHS	
--	610-0170-00			1	ASSEMBLY, LOW PASS FILTER	
	- - - - -			-	assembly includes:	
	124-0180-00			1	STRIP, terminal (not shown)	
-113	- - - - -			4	CAPACITOR, w/hardware	
-114	131-0372-00			2	CONNECTOR, coaxial, 1 contact, w/hardware	
-115	337-0806-00			2	SHIELD	
	- - - - -				mounting hardware for each: (not included w/shield)	
	213-0138-00			1	SCREW, sheet metal, #4 x 3/16 inch, PHS	
-116	441-0669-01			1	CHASSIS	
	- - - - -				mounting hardware: (not included w/assembly)	
-117	210-0586-00			2	NUT, keps, 4-40 x 1/4 inch	
--	610-0171-00			1	ASSEMBLY, LOW PASS FILTER 235 MHz	
	- - - - -				assembly includes:	
-118	131-0372-00			2	CONNECTOR, coaxial, 1 contact, w/hardware	
-119	337-0806-00			2	SHIELD	
	- - - - -			-	mounting hardware for each: (not included w/shield)	
	213-0138-00			1	SCREW, sheet metal, #4 x 3/16 inch, PHS	
-120	441-0669-02			1	CHASSIS	
-121	- - - - -			4	CAPACITOR, w/hardware	
	- - - - -			-	mounting hardware: (not included w/assembly)	
-122	210-0586-00			2	NUT, keps, 4-40 x 1/4 inch	

FIG. 3 IF CHASSIS & PHASE LOCK ASSEMBLIES (cont)

Fig. & Index No.	Tektronix Part No.	Serial/Model Eff	No. Disc	Q					Description	
				t	y	1	2	3		4
3-123	337-0805-00			2						SHIELD, filter
-124	213-0138-00			-						mounting hardware for each: (not included w/shield)
				4						SCREW, sheet metal, #4 x 3/16 inch, PHS
-125	175-0414-00			1						ASSEMBLY, cable, 9 inches (J1 140 to J42B)
-126	174-0414-00			1						ASSEMBLY, cable, 9 inches (J1 150 to J41 B)
-1 2 7	175-0409-00	B0101 00	B010111	1						ASSEMBLY, cable, 6 1/4 inches (J1 160 to J40B)
	175-0411-00	B010112		1						ASSEMBLY, cable, 6 inches (J1 160 to J40B)
-128	175-0408-00			1						ASSEMBLY, cable, 4 1/2 inches (J80 to J75)
-129	175-0410-00			1						ASSEMBLY, cable, 5 1/2 inches (J34 to J71)
-130	175-0411-00			1						ASSEMBLY, cable, 6 inches (J20 to J18)
-131	175-0409-00			1						ASSEMBLY, cable, 5 1/4 inches (J50 to J47)
-1 3 2	175-0412-00	B010100	B090409	1						ASSEMBLY cable, 7 inches (J52 to J73)
	175-0310-00	B09041 0		1						ASSEMBLY, cable, 7 inches (J52 to J73)
-1 3 3	175-0312-00	B0101 00	B069999	1						ASSEMBLY, cable, 9 inches (J45 to J42A)
	175-0473-00	B070000		1						ASSEMBLY, cable, 9 inches (J45 to J42A)
-134	- - - - -			1						ASSEMBLY, cable, (J46 to BAND "C" ASSEMBLY) (see Fig. 1 FRONT)
-135	- - - - -			1						ASSEMBLY, cable, (J10 to J1 ) (see Fig. 1 FRONT)
-136	175-0416-00			1						ASSEMBLY, cable, (J14 to J40A)
-137	119-0091-00			1						DIVIDER, resistive

FIG. 4 POWER CHASSIS

Fig. & Index No.	Tektronix Part No.	Serial/Model No.		Q † Y	1	2	3	4	5	Description
		Eff	Disc							
4 - 1	- - - - -			1						TRANSFORMER mounting hardware: (not included w/transformer)
- 2	212-0522-00			4						SCREW, 10-32 x 2 1/2 inches, HHS
- 3	210-0812-00			4						WASHER, fiber, #10
- 4	354-0019-01			1						RING
- 5	220-0410-00			4						NUT, keps, 10-32 x 3/8 inch
- 6	200-0533-00			1						COVER, capacitor, plastic, 1 ID x 0.150 inch long
- 7	- - - - -			2						CAPACITOR mounting hardware for each: (not included w/capacitor)
- 8	211-0504-00			2						SCREW, 6-32 x 5/16 inch, PHS
- 9	386-0255-00			1						PLATE, metal, large
- 10	432-0048-00			1						BASE, plastic, large
- 11	384-0519-00			2						ROD, hex., 1/4 x 9/16 inch
- 12	211-0514-00			2						SCREW, 6-32 x 3/4 inch, PHS
- 13	- - - - -			1						CAPACITOR mounting hardware: (not included w/capacitor)
- 14	211-0507-00			2						SCREW, 6-32 x 5/16 inch, PHS
- 15	386-0252-00			1						PLATE, fiber, small
- 16	432-0047-00			1						BASE, plastic, small
- 17	384-0519-00			2						ROD, hex., 1/4 x 9/16 inch
- 18	211-0514-00			2						SCREW, 6-32 x 3/4 inch, PHS
- 19	- - - - -			2						RESISTOR mounting hardware for each: (not included w/resistor)
- 20	211-0544-00			1						SCREW, 6-32 x 3/4 inch, THS
- 21	210-0478-00			1						NUT, hex., 5/16 x 2 1/32 inch long
- 22	211-0507-00			1						SCREW, 6-32 x 5/16 inch, PHS
- 2 3	260-0398-00 B0101 00 260-0834-00 B1 50000		B159999	1						SWITCH, toggle—POWER OFF-ON
- 24	210-0046-00			1						SWITCH, toggle—POWER OFF-ON mounting hardware: (not included w/switch)
- 25	210-0940-00			1						LOCKWASHER, internal, 1/4 ID x 0.400 inch OD
- 26	210-0562-00			1						WASHER, flat, 1/4 ID x 3/8 inch OD NUT, hex., 1/4-40 x 5/16 inch
- 27	- - - - -			4						TRANSISTOR mounting hardware for each: (not included w/transistor)
- 28	211-0510-00			2						SCREW, 6-32 x 3/8 inch, PHS
- 29	386-0143-00			1						PLATE, mica, insulator
	210-0811-00			2						WASHER, fiber, #6, shouldered (not shown)
	210-0202-00			1						LUG, solder, SE #6 (not shown)
	210-0802-00			2						WASHER, flat, 0.150 ID x 5/16 inch OD (not shown)
	210-0457-00			2						NUT, keps, 6-32 x 5/16 inch (not shown)

FIG. 4 POWER CHASSIS (cont)

Fig. & Index No.	Tektronix Part No.	Serial/Model Eff	No. Disc	Q					Description
				y	1	2	3	4	
4-30	- - - - -			1					TRANSISTOR
	- - - - -			-					mounting hardware: (not included w/transistor)
-31	211-0510-00			2					SCREW, 6-32 x 3/8 inch, PHS
-32	386-0978-00			1					PLATE, mica. insulator
-33	210-0975-00			2					WASHER, fiber, shouldered, 0.140 ID x 0.375 inch OD
-34	210-0802-00			2					WASHER, flat, 0.150 ID x 5/16 inch OD
-35	210-0202-00			1					LUG, solder, SE #6
-36	210-0457-00			2					NUT, keps, 6-32 x 5/16 inch
-37	- - - - -			1					THERMAL CUTOUT
	- - - - -			-					mounting hardware: (not included w/thermal cutout)
-38	211-0008-00			2					SCREW, 4-40 x 1/4 inch, PHS
-39	210-0586-00			2					NUT, keps, 4-40 x 1/4 inch
-40	670-0507-00			1					ASSEMBLY, circuit board—LOW VOLTAGE POWER SUPPLY
	- - - - -			-					assembly includes:
	388-0801-00			1					BOARD, circuit
-41	214-0506-00			1					PIN, connector, male
-42	136-0183-00			2					SOCKET, transistor, 3 pin
-43	136-0220-00			11					SOCKET, transistor, 3 pin
	- - - - -			-					mounting hardware: (not included w/assembly)
-44	211-0116-00			4					SCREW, sems, 4-40 x 5/16 inch, PHB
-45	200-0709-00			1					COVER, transistor
-46	210-0201-00			1					LUG, solder, SE #4
	- - - - -			-					mounting hardware: (not included w/lug)
-47	213-0044-00			1					SCREW, thread forming, 5-32 x 3/16 inch, PHS
-48	348-0050-00			1					GROMMET, plastic, 3/4 inch diameter
-49	407-0307-00			1					BRACKET, angle
	- - - - -			-					mounting hardware: (not included w/bracket)
-50	210-0457-00			2					NUT, keps, 6-32 x 5/16 inch
-51	407-0275-00			1					BRACKET, angle
	- - - - -			-					mounting hardware: (not included w/bracket)
-52	210-0586-00			2					NUT, keps, 4-40 x 1/4 inch
-53	131-0373-00			2					CONNECTOR, terminal standoff
	- - - - -			-					mounting hardware for each: (not included w/connector)
-54	210-0001-00			1					LOCKWASHER, internal, #2
-55	210-0405-00			1					NUT, hex., 2-56 x 3/16 inch
-56	441-0689-00			1					CHASSIS, power
	- - - - -			-					mounting hardware: (not included w/chassis)
	211-0507-00			12					SCREW, 6-32 x 5/16 inch, PHS

FIG. 4 POWER CHASSIS (cont)

Fig. & Index No.	Tektronix Part No.	Serial/Model No. Eff Disc	Q † Y	1 2 3 4 5					Description
				1	2	3	4	5	
4-57	358-0215-00		1						BUSHING, plastic
-58	670-0505-00		1						ASSEMBLY, circuit board—IF CONTROL assembly includes:
	388-0799-00		1						BOARD, circuit
-59	214-0506-00		54						PIN, connector, male
-60	136-0183-00		1						SOCKET, transistor, 3 pin
-61	136-0220-00		11						SOCKET, transistor, 3 pin
-62	136-0235-00		1						SOCKET, transistor, dual
-63	426-0121-00		4						MOUNT, toroid, plastic
-64	361-0007-00		4						SPACER, plastic, 0.188 inch long mounting hardware: (not included w/assembly)
-65	211-0116-00		5						SCREW, sems. 4-40 x 5/16 inch, PHB
-66	407-0273-00		1						BRACKET, circuit board - bracket includes:
-67	210-1016-00		1						WASHER, spring, 0.228 ID x 0.375 inch OD
-68	214-0788-00		1						LATCH
-69	129-0107-00		1						POST, snapslide fastener - mounting hardware: (not included w/bracket)
-70	214-0793-00		1						PIN, hinge
-71	344-0137-00		1						CLIP, retaining
-72	343-0136-00		2						CLAMP, loop
-73	343-0089-00		2						CLAMP, cable, plastic, large
-74	348-0100-00		1						GROMMET, plastic, 7/8 inch diameter
-75	179-1094-00		1						CABLE HARNESS, IF control - cable harness includes:
-76	131-0371-00		77						CONNECTOR, single contact
-77	179-1095-00		1						CABLE HARNESS, power #1 - cable harness includes:
-78	131-0371-00		56						CONNECTOR, single contact, female
-79	407-0276-00		1						BRACKET mounting hardware: (not included w/bracket)
-80	211-0008-00		2						SCREW, 4-40 x 1/4 inch, PHS
-81	210-0201-00		2						LUG, solder, 3/8 ID x 5/8 inch OD, SE
-82	211-0504-00		2						SCREW, 6-32 x 1/4 inch, PHS



FIG. 5 TIME/DIV SWITCH & OSCILLATOR ASSEMBLIES

Fig. & Index No.	Tektronix Part No.	Serial/Model No. Eff Disc	Q † Y	1 2 3 4 5					Description
				1	2	3	4	5	
5-1	262-0787-00		1						SWITCH, wired—TIME/DIV
	- - - - -		-						switch includes:
	260-0819-00		1						SWITCH, unwired
- 2	- - - - -		1						RESISTOR, variable
	- - - - -								mounting hardware: (not included w/resistor)
- 3	210-0012-00		1						LOCKWASHER, internal, 3/8 x 1/2 inch OD
- 4	210-0413-00		2						NUT, hex., 3/8-32 x 1/2 inch
	- - - - -								
- 5	376-0014-00		1						COUPLING, wire
- 6	376-0007-00		1						COUPLING
	- - - - -		-						coupling includes:
- 7	213-0005-00		2						SCREW, set, 8-32 x 1/8 inch, HSS
- 8	- - - - -		1						CAPACITOR
	- - - - -								mounting hardware: (not included w/capacitor)
- 9	352-0050-00		1						HOLDER
	- - - - -								
- 10	384-0651-00		1						SHAFT, extension
- 11	384-0652-00		1						SHAFT, extension
	- - - - -								mounting hardware: (not included w/switch)
	210-0978-00		1						WASHER, flat, 3/8 ID x 1/2 inch OD
	210-0012-00		1						LOCKWASHER, internal, 3/8 ID x 1/2 inch OD
	210-0590-00		1						NUT, hex., 3/8-32 x 7/16 inch
	- - - - -								
- 12	670-0503-00		1						ASSEMBLY, circuit board—HORIZONTAL DISPLAY
	- - - - -		-						assembly includes:
	388-0797-00		1						BOARD, circuit
- 13	214-0506-00		26						PIN, connecting, male
- 14	136-0183-00		2						SOCKET, transistor, 3 pin
- 15	136-0220-00		18						SOCKET, transistor, 3 pin
	- - - - -								mounting hardware: (not included w/assembly)
- 16	352-0071-00		6						HOLDER
- 17	211-0116-00		6						SCREW, sems, 4-40 x 5/16 inch, PHB
	- - - - -								
- 18	- - - - -		1						RESISTOR, variable
	- - - - -		-						mounting hardware: (not included w/resistor)
- 19	210-0046-00		1						LOCKWASHER, internal, 1/4 ID x 0.400 inch OD
- 20	210-0940-00		1						WASHER, flat, 1/4 ID x 3/8 inch OD
- 21	210-0583-00		1						NUT, hex., 1/4-32 x 5/16 inch
	- - - - -								
- 22	407-0274-00		1						BRACKET
	- - - - -		-						mounting hardware: (not included w/bracket)
- 23	211-0008-00		2						SCREW, 4-40 x 1/4 inch, PHS
- 24	352-0071-00		2						HOLDER
- 25	210-0586-00		4						NUT, keps, 4-40 x 1/4 inch
- 26	210-0449-00		4						NUT, hex., 5-40 x 1/4 inch

FIG. 5 TIME/DIV SWITCH & OSCILLATOR ASSEMBLIES (cont)

Fig. & Index No.	Tektronix Part No.	Serial/Model No. Eff	No. Disc	Q † Y	1 2 3 4 5					Description
					1	2	3	4	5	
5-27	179-1093-00			1						CABLE HARNESS, sweep
	- - - - -			-						cable harness includes:
-28	131-0371-00			32						CONNECTOR, single contact
	119-0106-00			1						ASSEMBLY, oscillator
	- - - - -									assembly includes:
	670-0523-00	XB1	50740	1						ASSEMBLY, circuit board—OSCILLATOR CONNECTOR
	- - - - -			-						assembly includes:
	388-0816-00			1						BOARD, circuit
	214-0506-00			1						PIN, connector, male
	179-1099-00			1						CABLE HARNESS
	- - - - -			-						cable harness includes:
	131-0371-00			2						CONNECTOR, single contact, female
	132-0014-00			1						SLEEVE
	- - - - -									mounting hardware: (not included w/assembly)
	211-0116-00			2						SCREW, sems, 4-40 x 5/16 inch, PHS
-29	119-0063-01			1						OSCILLATOR
	- - - - -			-						mounting hardware: (not included w/oscillator)
	210-0006-00			2						LOCKWASHER, internal, #6
-30	211-0564-00			2						SCREW, 6-32 x 0.375 inch, Socket HS
-31	119-0108-00			1						OSCILLATOR ASSEMBLY, RF
	- - - - -									oscillator includes:
	119-0105-00			1						VARACTOR ASSEMBLY
	- - - - -									mounting hardware: (not included w/varactor)
	213-0048-00			2						SCREW, set, 4-40 x 1/8 inch, HSS
	119-0107-00			1						PROBE, waveguide
	119-0107-01			1						PROBE, waveguide
	- - - - -									mounting hardware for each: (not included w/probe)
	213-0048-00			2						SCREW, set, 4-40 x 1/8 inch, HSS
	- - - - -									mounting hardware: (not included w/oscillator assembly)
-32	211-0559-00			1						SCREW, 6-32 x 0.375 inch, 100° csk, FHS
	210-0006-00			3						LOCKWASHER, internal, #6
-33	211-0510-00			3						SCREW, 6-32 x 0.375 inch, PHS
	331-0176-00			1						DIAL ASSEMBLY, tape
	- - - - -									dial assembly includes:
-34	380-0111-01			1						HOUSING, dial
-35	214-0758-00			6						GEAR, helical
	- - - - -			-						mounting hardware for each: (not included w/gear)
	213-0075-00			2						SCREW, set, 4-40 x 0.094 inch, HSS (not shown)
-36	210-1011-00			7						WASHER, plastic, 0.130 ID x 0.375 inch OD
-37	210-0839-00			1						WASHER, end play, 1/4 ID x 7/16 inch OD
-38	214-0803-00			1						LEVER
	- - - - -			-						mounting hardware: (not included w/lever)
	213-0075-00			2						SCREW, set, 4-40 x 0.094 inch, HSS (not shown)
-39	214-0801-00			1						LEVER SHAFT
-40	384-0424-00	B010100	B130499	1						EXTENSION SHAFT
	384-0691-00	B130500		1						EXTENSION SHAFT
	- - - - -			-						mounting hardware: (not included w/extension shaft)
	213-0075-00	B010100	B130499	2						SCREW, set, 4-40 x 0.094 inch, HSS (not shown)
	220-0491-00	B130500		1						NUT, hex., 3/8-32 x 0.438 inch
-41	384-0421-00			2						SHAFT

FIG. 5 TIME/DIV SWITCH & OSCILLATOR ASSEMBLIES (cont)

Fig. & Index No.	Tektronix Part No.	Serial/Model No. Eff	No. Disc	Q † Y	1 2 3 4 5					Description
					1	2	3	4	5	
5-42	384-0423-00			2						SHAFT
-	- - - - -			-						mounting hardware for each: (not included w/shaft)
-43	344-0137-00			2						CLIP, retaining
-44	384-0422-00			1						SHAFT
-45	210-0906-00			1						WASHER, fiber, 1/8 ID x 13/64 inch OD
-46	376-0051-00			1						COUPLING, flexible
-	- - - - -			-						coupling includes:
-	213-0075-00			4						SCREW, set, 4-40 x 0.094 inch, HSS
-	376-0049-00			1						COUPLING, plastic
-	354-0251-00			2						RING, coupling
-47	361-0136-00			1						SPACER, sprocket
-48	214-0520-00	B010100	B129999	1						SPROCKET, tape
-	214-0520-01	B130000		1						SPROCKET, tape
-	- - - - -									mounting hardware: (not included w/sprocket)
-	213-0075-00			2						SCREW, set, 4-40 x 0.094 inch, HSS (not shown)
-49	214-0804-00	B010100	B129999	1						SPOOL EXTENSION
-	214-0804-02	B1 30000		4						SPOOL EXTENSION
-	- - - - -									mounting hardware: (not included w/spool extension)
-	213-0075-00			1						SCREW, set, 4-40 x 0.094 inch, HSS (not shown)
-50	214-0805-00			4						SPOOL
-	211-1011-00	XB120000		3						WASHER, plastic (not shown)
-	213-0075-00	XB120000		3						SCREW, set, 4-40 x 3/32 inch, HSS (not shown)
-51	331-0179-00			1						DIAL TAPE
-52	386-1181-00			1						PLATE, dial window mounting
-	- - - - -			-						mounting hardware: (not included w/plate)
-53	211-0069-00			2						SCREW, 2-56 x 1/8 inch, PHS
-54	386-1131-00			1						PLATE, dial window
-	- - - - -									mounting hardware: (not included w/plate)
-55	214-0565-00			4						FASTENER, press
-	- - - - -			-						mounting hardware: (not included w/dial assembly)
-	210-0004-00			4						LOCKWASHER, internal, #4
-56	210-0012-00			4						SCREW, 4-40 x 0.375 inch, PHS
-57	384-0425-00			1						ROD, coupling
-	- - - - -			-						mounting hardware: (not included w/rod)
-58	213-0075-00			4						SCREW, set, 4-40 x 0.094 inch, HSS
-59	260-0821-00			1						SWITCH, lever—BAND SWITCH
-	- - - - -			-						mounting hardware: (not included w/switch)
-	210-053-00			2						LOCKWASHER, split, #2
-60	210-0405-00			2						NUT, hex., 2-56 x 3/16 inch
-61	337-0880-00			1						SHIELD, switch
-	- - - - -			-						mounting hardware: (not included w/shield)
-62	211-0062-00			1						SCREW, 2-56 x 5/16 inch, RHS
-	210-0053-00			1						LOCKWASHER, split, #2
-63	210-0405-00			1						NUT, hex., 2-56 x 3/16 inch

FIG. 5 TIME/DIV SWITCH & OSCILLATOR ASSEMBLIES (cont)

Fig. & Index No.	Tektronix Part No.	Serial/Model Eff	No. Disc	Q † Y	Description				
					1	2	3	4	5
5-64	407-0294-00			1	BRACKET, support				
-65	407-0295-00			1	BRACKET, support mounting hardware: (not included w/bracket)				
-66	213-0004-00			2	SCREW, set, 6-32 x 3/16 inch, HSS				
-67	211-0504-00			2	SCREW, 6-32 x 1/4 inch, PHS				
-68	210-0006-00			2	LOCKWASHER, internal, #6				
-69	131-0391-00			4	CONNECTOR, coaxial, 1 contact				
-70	386-1135-00			1	PLATE, mounting - mounting hardware: (not included w/assembly)				
	337-1015-00	XB1 10000		1	SHIELD, oscillator wraparound (not shown)				
	211-0133-00			1	SCREW, 4-40 x 0.25 inch, Socket HS (not shown)				
-71	210-0586-00			2	NUT, keps, 4-40 x 1/4 inch				
	211-0507-00			2	SCREW, 6-32 x 5/16 inch, PHS (not shown)				
-72	337-0910-00	B01 0000	B029999	1	SHIELDING GASKET				
	337-0910-01	B030000		1	SHIELDING GASKET				
-73	670-0523-00	B0101 00	B150739X	1	ASSEMBLY, circuit board—OSCILLATOR CONNECTOR assembly includes:				
	388-0816-00			1	BOARD, circuit				
-74	214-0506-00			1	PIN, connector, male				
-75	179-1099-00			1	CABLE HARNESS - cable harness includes:				
-76	131-0371-00			2	CONNECTOR, single contact, female				
-77	77132-0014-00			1	SLEEVE - mounting hardware: (not included w/assembly)				
-78	211-0116-00			2	SCREW, sems, 4-40 x 5/16 inch, PHS				
-79	. . . . .			1	ASSEMBLY, cable, 11 inches (J40A to J14) (see Fig. 3 - IF CHASSIS & PHASE LOCK ASSEMBLY)				
-80	. . . . .			1	ASSEMBLY, cable, 5 1/2 inches (J40B to J1160) (see Fig. 3 - IF CHASSIS & PHASE LOCK ASSEMBLY)				
-81	. . . . .			1	ASSEMBLY, cable, 12 inches (J51A to J65) (see Fig. 1 - FRONT)				
-82	. . . . .			1	ASSEMBLY, cable, 9 inches (J41 B to J1150) (see Fig. 3 - IF CHASSIS & PHASE LOCK ASSEMBLY)				
-83	. . . . .			1	ASSEMBLY, cable, 9 inches (J42A to J45) (see Fig. 3 - IF CHASSIS & PHASE LOCK ASSEMBLY)				
-84	. . . . .			1	ASSEMBLY, cable, 9 inches (J42B to J1140) (see Fig. 3 - IF CHASSIS & PHASE LOCK ASSEMBLY)				
-85	. . . . .			1	ASSEMBLY, cable, 5 1/2 inches (J71 to J34) (see Fig. 3 - IF CHASSIS & PHASE LOCK ASSEMBLY)				
-86	. . . . .			1	ASSEMBLY, cable, 10 inches (J72 to J69) (see Fig. 1 - FRONT)				
-87	. . . . .			1	ASSEMBLY, cable, 7 inches (J73 to J52) (see Fig. 3 - IF CHASSIS & PHASE LOCK ASSEMBLY)				
-88	. . . . .			1	ASSEMBLY, cable, 4 1/2 inches (J75 to J80) (see Fig. 3 - IF CHASSIS & PHASE LOCK ASSEMBLY)				

FIG. 6 CRT SHIELD ASSEMBLY

Fig. & index No.	Tektronix Part No.	Serial/Model No.		Q t Y	Description
		Eff	Disc		
6-	626-0440-00			1	ASSEMBLY, CRT shield
	- - - - -				assembly includes:
-1	337-0754-00			1	SHIELD, CRT
-2	- - - - -			1	COIL
	- - - - -			-	mounting hardware: (not included w/coil)
-3	21 1 -0590-00	B010100	B050319	3	SCREW, 6-32 x 1/4 inch, PHS
	213-0149-00	B050320		1	SCREW, thread forming, #6 x 0.375 inch PHS
-4	348-0070-01			4	CUSHION
-5	358-0281-00			1	BUSHING, plastic
-6	343-0122-01			2	CLAMP
	- - - - -			-	mounting hardware for each: (not included w/clamp)
-7	213-0049-00			1	SCREW, 6-32 x 5/16 inch, HHS
-8	210-0949-00			1	WASHER, flat, 7/64 ID x 1/2 inch OD
-9	343-0123-01			2	CLAMP
	- - - - -				mounting hardware for each: (not included w/clamp)
-10	211-0590-00			2	SCREW, 6-32 x 1/4 inch, PHS
-11	343-0124-00			1	CLAMP, plastic
	- - - - -				mounting hardware: (not included w/clamp)
-12	211-0599-00			2	SCREW, 6-32 x 3/4 inch, FIL HS
-13	220-0444-00			2	NUT, square, 6-32 x 1/4 inch
-14	352-0091-01			2	HOLDER
	- - - - -			-	mounting hardware for each: (not included w/holder)
-15	211-0600-00			1	SCREW, 6-32 x 2 inches FIL HS
-16	220-0444-00			1	NUT, square, 6-32 x 1/4 inch
	- - - - -			-	mounting hardware: (not included w/assembly)
-17	210-0586-00	B010100	B090439	2	NUT, keps, 4-40 x 1/4 inch
	220-0413-00	B090440		2	NUT, hex., 4-40 x 3/16 x 0.562 inch long
-18	212-0004-00			2	SCREW, 8-32 x 5/16 inch, PHS
	210-0858-00			2	WASHER, flat, 11/64 ID x 1/2 inch OD (not shown)
-19	136-0205-00			1	SOCKET, graticule lamp
-20	175-0691-00			1	WIRE, CRT lead, brown stripe
	175-0692-00			1	WIRE, CRT lead, red stripe
	175-0693-00			1	WIRE, CRT lead, green stripe
	175-0694-00			1	WIRE, CRT lead, blue stripe
	- - - - -			-	each wire includes:
-21	131-0371-00			1	CONNECTOR, single contact, female
-22	131-0049-00			1	CONNECTOR, cable end, female

FIG. 7 CABINET ASSEMBLY AND HANDLE

Fig. & Index No.	Tektronix Part No.	Serial/Model Eff	No. Disc	Q					Description	
				f	y	1	2	3		4
7-1	437-0088-01			1						ASSEMBLY, cabinet assembly includes:
-2	348-0079-00			2						FOOT, plastic cap
-3	348-0078-00			2						FOOT, plastic mounting hardware for each: (not included w/foot)
-4	212-0022-00			1						SCREW, 8-32 x 1 1/2 inches, RHS
-5	210-1018-00			1						WASHER, flat, 0.203 ID x 0.937 inch OD
-6	210-0458-00			1						NUT, keps, 8-32 x 1 1/32 inch
-7	348-0079-00			2						FOOT, plastic cap
-8	348-0078-00			2						FOOT, plastic mounting hardware for each: (not included w/foot)
-9	212-0022-00			1						SCREW, 8-32 x 1 1/2 inches, RHS
-10	210-1018-00			1						WASHER, flat, 0.203 ID x 0.937 inch OD
-11	214-0808-00			1						NUT, guide, hex., 8-32 x 0.75 inch long
-12	214-0766-00			2						THUMBSCREW, 0.250-20 x 0.50 x 1.125 inches long mounting hardware for each: (not included w/thumb screw)
-13	210-1017-00			1						WASHER, plastic, 0.281 ID x 0.875 inch OD
-14	354-0299-00			1						RING, retaining
-15	348-0025-00	B0101 00	B049999	2						FOOT, plastic
	348-0025-01	B050000		2						FOOT, plastic mounting hardware for each: (not included w/foot)
-16	211-0507-00			1						SCREW, 6-32 x 5/16 inch, PHS
-17	220-0479-00	B0101 00	B049999	1						NUT, plastic
	210-0437-00	B050000		1						NUT, speed, #6
-18	348-0025-00	B0101 00	B049999	2						FOOT, plastic
	348-0025-01	B050000		2						FOOT, plastic
	220-0479-00	B0101 00	B049999	2						NUT, plastic
	210-0437-00	B050000		2						NUT, speed, #6
-19	367-0069-00			1						HANDLE, carrying mounting hardware: (not included w/handle)
-20	211-0512-00			4						SCREW, 6-32 x 1/2 inch, 100° csk, FHS
-21	214-0516-00			2						SPRING, handle index
-22	214-0513-00			2						INDEX, handle ring
-23	214-0515-00			2						INDEX, handle hub mounting hardware for each: (not included w/index)
-24	213-0139-00			1						SCREW, 10-24 x 3/8 inch, HHS
-25	210-0805-00			1						WASHER, flat, 0.204 ID x 0.438 inch OD

APPENDIX A  
BASIC ISSUE ITEMS LIST

---

Basic issue items list will be published at a later date.





## APPENDIX B

### MAINTENANCE ALLOCATION CHART

---

#### Section I. INTRODUCTION

##### B-1. General

This Maintenance Allocation Chart designates overall responsibility for the performance of maintenance functions on the identified end item or component. The implementation of field maintenance tasks upon this end item or component will be consistent with the assigned maintenance operations.

##### B-2. Maintenance Functions.

Maintenance functions will be limited to and defined as follows:

a. Inspect. To determine serviceability of an item by comparing its physical, mechanical and electrical characteristics with established standards.

b. Test. To verify serviceability and to detect electrical or mechanical failure by use of test equipment.

c. Service. To clean, to preserve, to charge and to add fuel, lubricants, cooling agents, and air. If it is desired that elements, such as painting and lubricating, be defined separately, they may be so listed.

d. Adjust. To rectify to the extent necessary to bring into proper operating range.

e. Align. To adjust specified variable elements of an item to bring to optimum performance.

f. Calibrate. To determine the corrections to be made in the readings of instruments or test equipment used in precise measurement. Consists of the comparison of two instruments, one of which is a certified standard of known accuracy, to detect and adjust any discrepancy in the accuracy of the instrument being compared with the certified standard.

g. Install. To set up for use in an operational environment such as an emplacement, site, or vehicle.

h. Replace. To replace unserviceable items with serviceable like items.

i. Repair. Those maintenance operations necessary to restore an item to serviceable condition through correction of material damage or a specific failure. Repair may be accomplished at each category of maintenance.

j. Overhaul. Normally, the highest degree of maintenance performed by the Army in order to minimize time work in process is consistent with quality and economy of operation. It consists of that maintenance necessary to restore an item to completely serviceable condition as prescribed by maintenance standards in technical publications for each item of equipment. Overhaul normally does not return an item to like new, zero mileage, or zero hour condition.

k. Rebuild. The highest degree of materiel maintenance. It consists of restoring equipment as nearly as possible to new condition in accordance with original manufacturing standards. Rebuild is performed only when required by operational considerations or other paramount factors and then only at the depot maintenance category. Rebuild reduces to zero the hours or miles the equipment, or component thereof, has been in use.

l. Symbols. The uppercase letter placed in the appropriate column indicates the lowest level at which that particular maintenance function is to be performed.

### B-3. Explanation of Columns.

Listed below is an explanation of the columns shown in the maintenance allocation chart:

a. Column 1, Group Number. Column 1 lists group numbers, the purpose of which is to identify components, assemblies, subassemblies and modules with the next higher assembly.

b. Column 2, Functional Group. Column 2 lists the noun names of components, assemblies, subassemblies and modules on which maintenance is authorized.

c. Column 3, Maintenance Functions. Column 3 lists the lowest level at which that particular maintenance function is to be performed.

d. Column 4, Tools and Equipment. This column shall be used to specify, by code, those tools and test equipment required to perform the designated function.

e. Column 5, Remarks. Self-explanatory.

Nomenclature of End Item or Component SPECTRUM ANALYZER TEKTRONIX 491

SECTION II - MAINTENANCE ASSIGNMENT

a Group Number	b Component Assembly Nomenclature	c Maintenance Function											d Tools and Equipment	e Remarks
		Inspect	Test	Service	Adjust	Align	Calibrate	Install	Replace	Repair	Overhaul	Rebuild		
	SPECTRUM ANALYZER	F	F	F	F	-	F	-	-	F	-	-		Repair and calibration to be performed in AN/TSM-55Y5 Maintenance Calibration Equipment Shelter
<p>LEGEND:</p> <p>C - Operator/Crew</p> <p>O - Organizational Maint.</p> <p>F - Direct Support Maint.</p> <p>H - General Support Maint.</p> <p>D - Depot Maint.</p>														



APPENDIX C  
REPAIR PARTS LIST

---

C-1. This appendix provides a list of repair parts for maintenance support of the equipment. The parts along with their descriptions are listed in table C-1 below.

C-2. Instructions for requisitioning parts not identified by Federal Stock Numbers require the following information be furnished to the Supply Officer:

a. Manufacturer's Federal Supply Code Number

b. Manufacturer's identification number

c. Manufacturer's nomenclature

d. My other information as listed on parts list that will aid in identification of the item being requisitioned.

C-3. If DD Form 1348 is used, fill in all blocks except 4, 5, 6 and Remarks field in accordance with AR 725-50. Complete Form as follows:

a. In Blocks 4, 5 and 6 list Manufacturer's Federal Supply Code Number followed by a colon and the Manufacturer's part number.

b. Complete Remarks Field as follows: Nomenclature of the repair part and any other identification to assist Supply Officer in procurement.

C-4. Report of errors, omissions and recommendation for improving this publication by the individual user is encouraged. Reports should be submitted on DA Form 2028 (Recommended Changes to DA Publications) and forwarded direct to Commanding Officer, Frankford Arsenal, ATTN: AMSWE-SMF-W3100, Philadelphia, Pa. 19137.

Table C-1. Repair Parts List

<u>Nomenclature</u>	<u>Mfg Part No.</u>	<u>Mfg Code No.</u>	<u>Qty</u>	<u>FSN</u>
BULB INCAND	150-0045-00	80009	1	6240-933-5821
BULB INCAND	150-0059-00	80009	1	6240-941-2683
XSTR SP8481	151-0104-00	80009	1	5961-923-9773
XSTR SIL 40V B	151-0108-00	80009	1	5961-759-9392
XSTR 2N3053	151-0136-00	80009	1	
XSTR SIL 2N3055	151-0140-00	80009	1	5961-724-2138
XSTR SIL NPN	151-0148-00	80009	1	5961-824-4173
XSTR 2N3441	151-0149-00	80009	1	
XSTR SIL 2N3440	151-0150-00	80009	3	
XSTR 2N2923	151-0153-00	80009	1	5961-121-9224
XSTR SIL NPN	151-0157-00	80009	1	5961-472-5667
XSTR SIL 2N3478	151-0173-00	80009	1	
XSTR SIL 2N3662	151-0175-00	80009	2	
XSTR SILRA 2554	151-0181-00	80009	2	
XSTR SIL 2N3906	151-0188-00	80009	4	5961-457-5187
XSTR 2N3904	151-0190-00	80009	2	
S 2NPH				
XSTR SIL MPS 6521	151-0192-00	80009	5	5961-879-7461
XSTR SI PNPTO-92	151-0199-00	80009	1	
XSTR SI NPN 2N3415	151-0207-00	80009	1	
XSTR SI RCA 40235	151-0230-00	80009	1	
XSTR SI TO-18	151-1007-00	80009	1	
DIODE GER 6075	152-0075-00	80009	1	5961-908-7598
DIODE GA-AS PAIR	152-0152-00	80009	1	5961-787-3672
DIODE SIL 10MA	152-0185-00	80009	1	5961-936-7604
XSTR SI SELECTED	153-0545-00	80009	1	
CRT T-4910-7-1	154-0502-00	80009	1	
TUBE SEL 1641	154-0506-00	80009	1	
TUBE ELECTRON ASSY	154-0510-00	80009	1	
CRYSTAL 5 MC	158-0019-00	80009	1	
CRYSTAL 70 MC	158-0024-00	80009	1	
CRYSTAL 1.0 MHZ	158-0025-00	80009	1	
FUSE 1. A FAST	159-0022-00	80009	5	
FUSE .5 A FAST	159-0025-00	80009	5	5920-933-5439
CAP CER .01 UF	283-0003-00	80009	1	5910-801-1005
RES COMP 1/4W 10	315-0100-00	80009	1	
RES COMP 1/4W 100	315-0101-00	80009	2	
RES COMP 1/4W 1K	315-0102-00	80009	1	
RES COMP 1/4W 10K	315-0103-00	80009	1	
RES COMP 1/4W 100K	315-0104-00	80009	1	
RES PREC 1/8W 4.02K	321-0251-00	80009	1	
RES PREC 1/8W 100K	321-0385-00	80009	1	

By Order of the Secretary of the Army:

Official:

KENNETH G. WICKHAM,  
Major General, United States Army,  
The Adjutant General.

W. C. WESTMORELAND,  
General, United States Army,  
Chief of Staff.

Distribution:

To be distributed in accordance with DA Form 12-37 (qty rqr block No. 201) operator maintenance requirements for Gun, 20-mm, XM163 and DA Form 12-40 (qty rqr block No. 168) operator and crew maintenance requirements for Gun, 20-mm, XM167.





SECTION 9. DIAGRAMS

MECHANICAL PARTS LIST ILLUSTRATIONS

ACCESSORIES



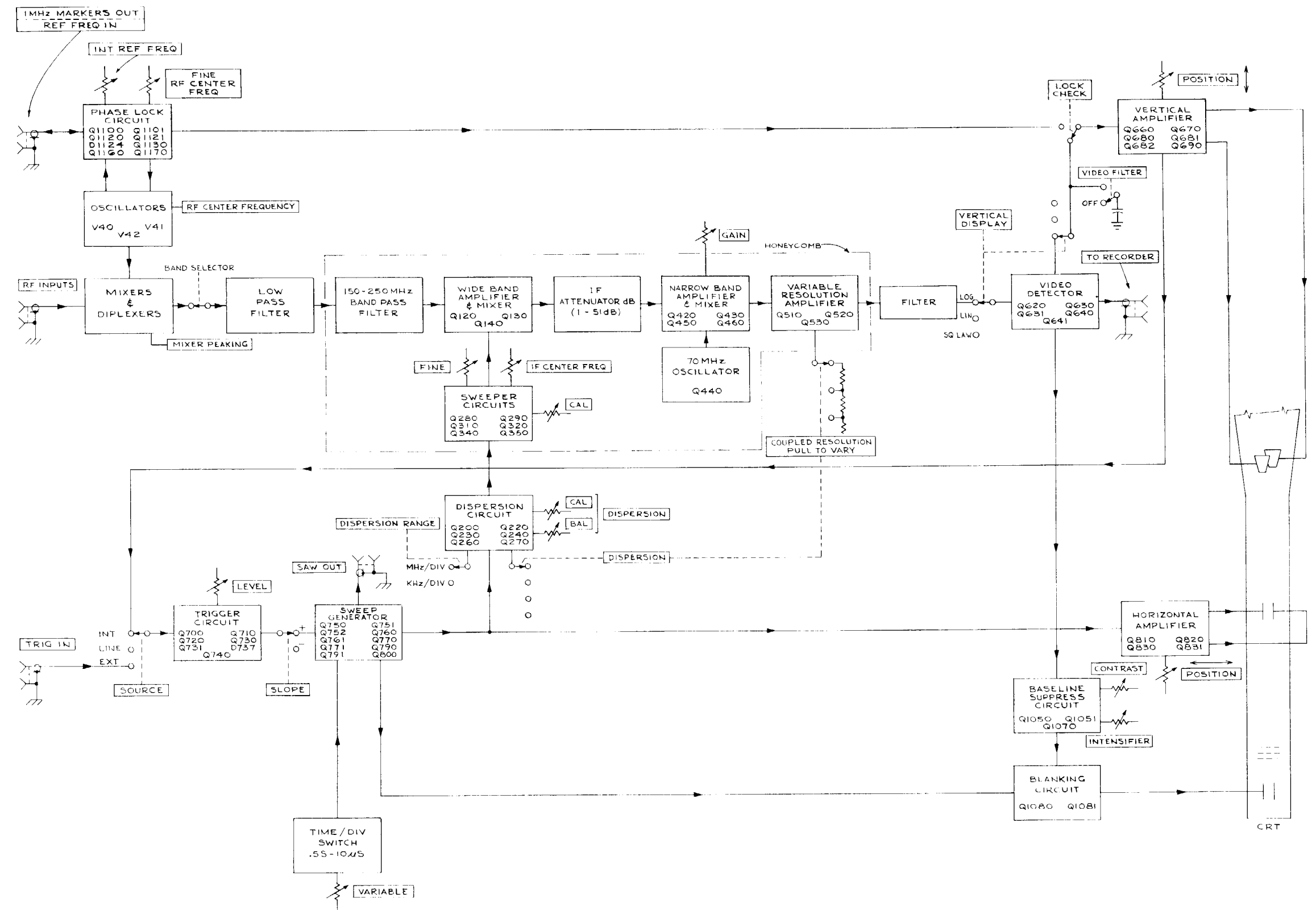

TYPE 491 SPECTRUM ANALYZER

A<sub>1</sub>

BLOCK DIAGRAM 1066

**IMPORTANT**

**VOLTAGE AND WAVEFORM CONDITIONS**

Circuit voltages measured with a DC coupled oscilloscope. All readings in volts. Readings are with respect to chassis ground unless otherwise noted.

Waveforms shown are actual waveform photographs taken with a Tektronix Oscilloscope Camera System.







Voltages and waveforms on the schematics (shown in blue) are not absolute and may vary between instruments. Any apparent differences between voltage levels measured and those shown on the waveforms may be due to circuit loading of the measuring device.

The waveforms were obtained with the Analyzer controls set as follows unless otherwise noted on the individual diagrams:

Signals Applied	200 MHz
DISPERSION RANGE	MHz/DIV
DISPERSION-COUPLED	500
RESOLUTION	
IF ATTENUATOR dB	OFF
IF CENTER FREQ	Controls centered (000)
GAIN	Midrange
TIME/DIV	20 ms
SOURCE	LINE
LEVEL	Adjust for a triggered display
VIDEO FILER	OFF
INTENSIFIER	OFF
POSITION	Adjusted for a centered trace at bottom graticule line.

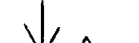
**Schematic Symbols**

The following symbols are used on the schematics:



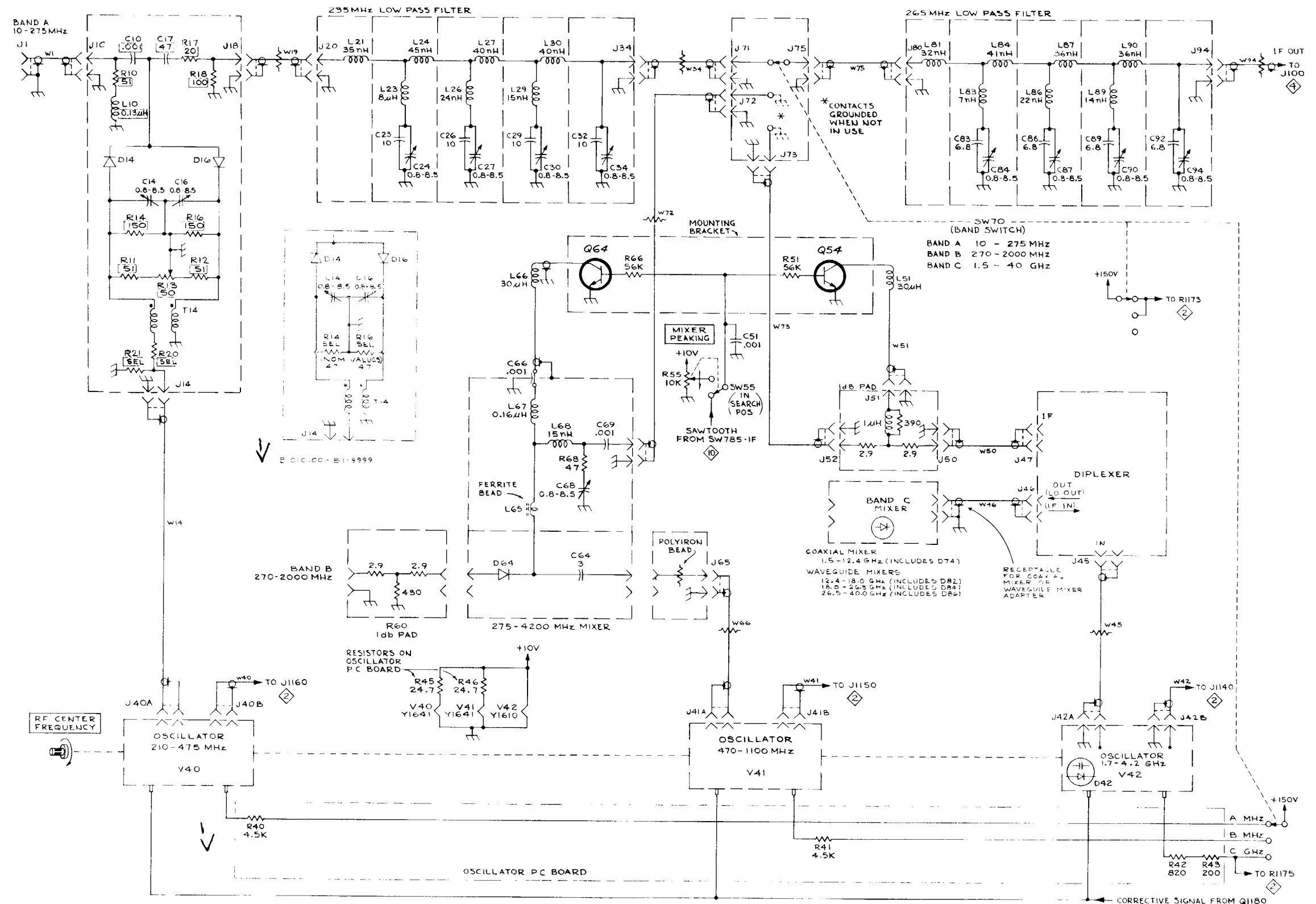

-  Screwdriver adjustment
-  Front-panel control or connector.
-  Clockwise control rotation in direction of arrow.
-  Connection made at indicated pin on etched-wiring board.
-  Connection soldered to etched-wiring board.
-  Blue line encloses components located on etched-wiring board.
-  Input from, or output to indicated schematic.



TYPE 491 SPECTRUM ANALYZER

See parts list for earlier values and serial number ranges of parts, also all component values encircled are included.

SEE PARTS LIST FOR SEMICONDUCTOR TYPES FOR POWER DISTRIBUTION SEE

- REFERENCE DIAGRAM:
-  PHASE LOCK CIRCUIT
  -  WIDE BAND AMPLIFIER
  -  TIMING SWITCH
  -  POWER DISTRIBUTION

RF SECTION

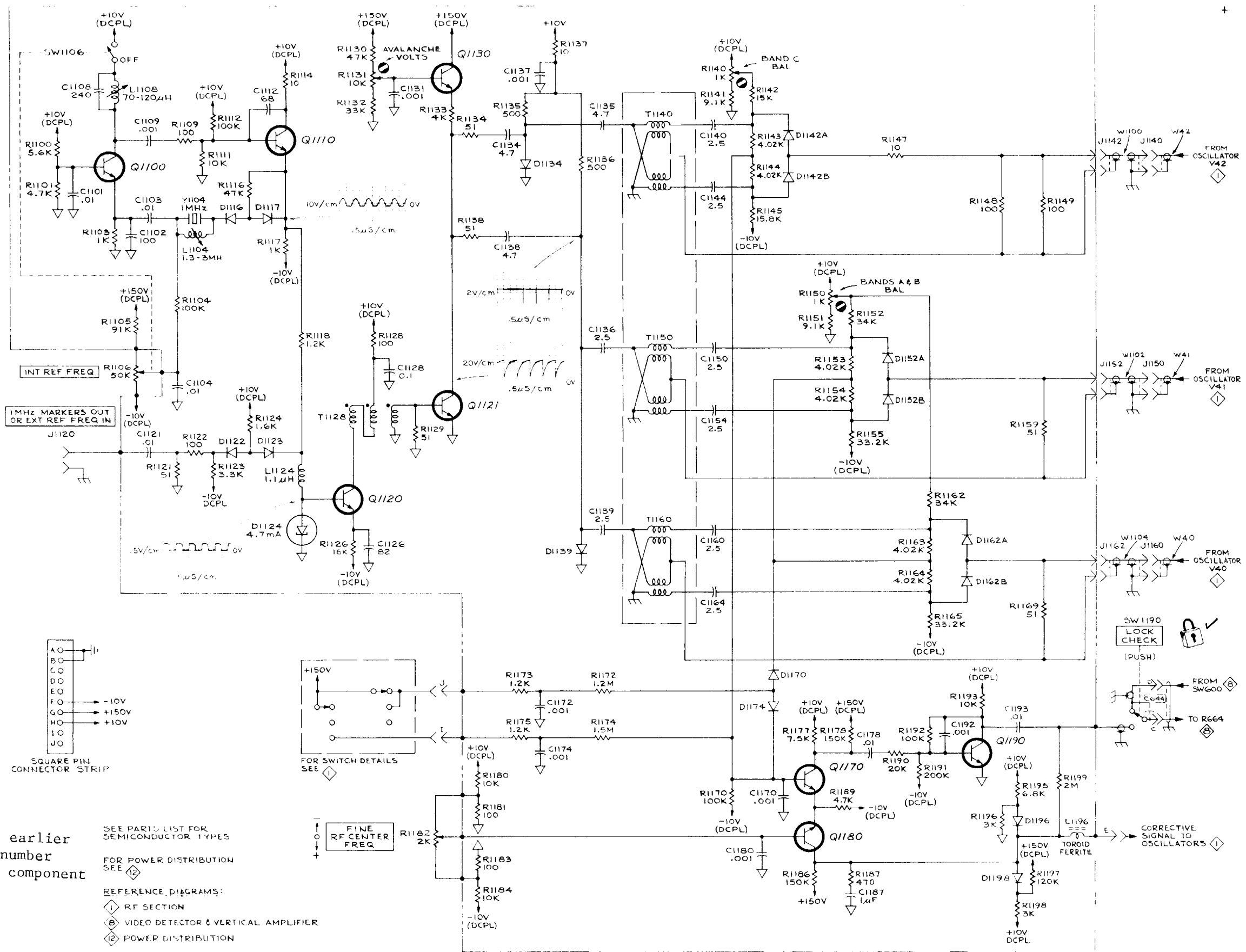

TYPE 491 SPECTRUM ANALYZER

PHASE LOCK CIRCUIT

See parts list for earlier values and serial number ranges of parts of component values encircled.

- SEE PARTS LIST FOR SEMICONDUCTOR TYPES
- FOR POWER DISTRIBUTION SEE
- REFERENCE DIAGRAMS:
- ① RF SECTION
  - ② VIDEO DETECTOR & VERTICAL AMPLIFIER
  - ③ POWER DISTRIBUTION

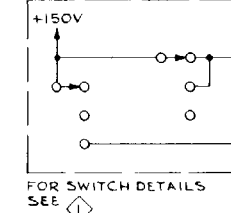
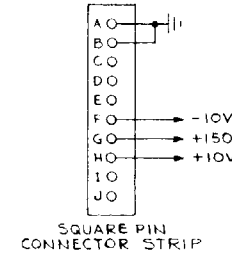

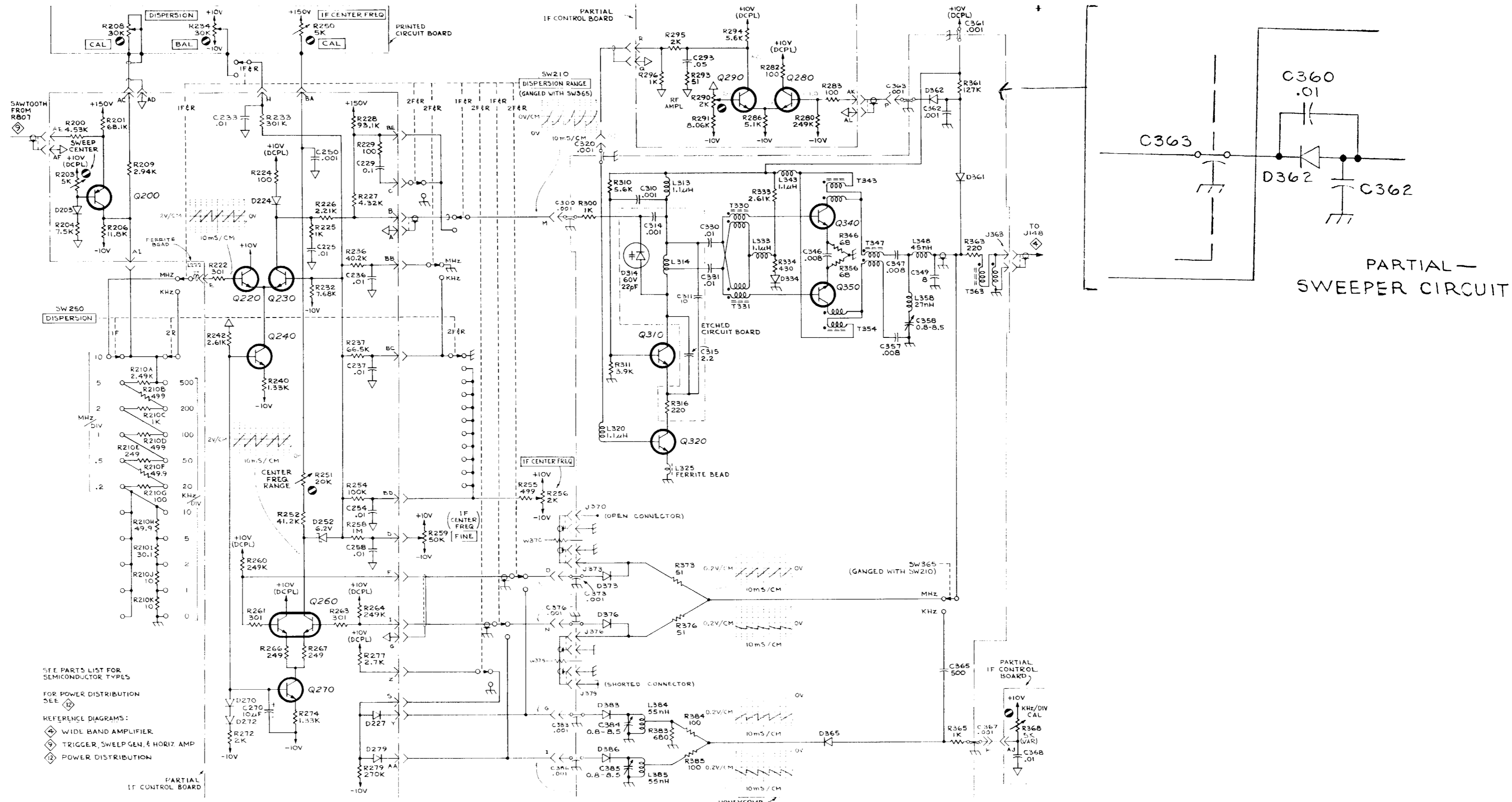

SEE PARTS LIST FOR SEMICONDUCTOR TYPES  
 FOR POWER DISTRIBUTION SEE [Symbol]  
 REFERENCE DIAGRAMS:  
 [Symbol] WIDE BAND AMPLIFIER  
 [Symbol] TRIGGER, SWEEP GEN. & HORIZ AMP  
 [Symbol] POWER DISTRIBUTION

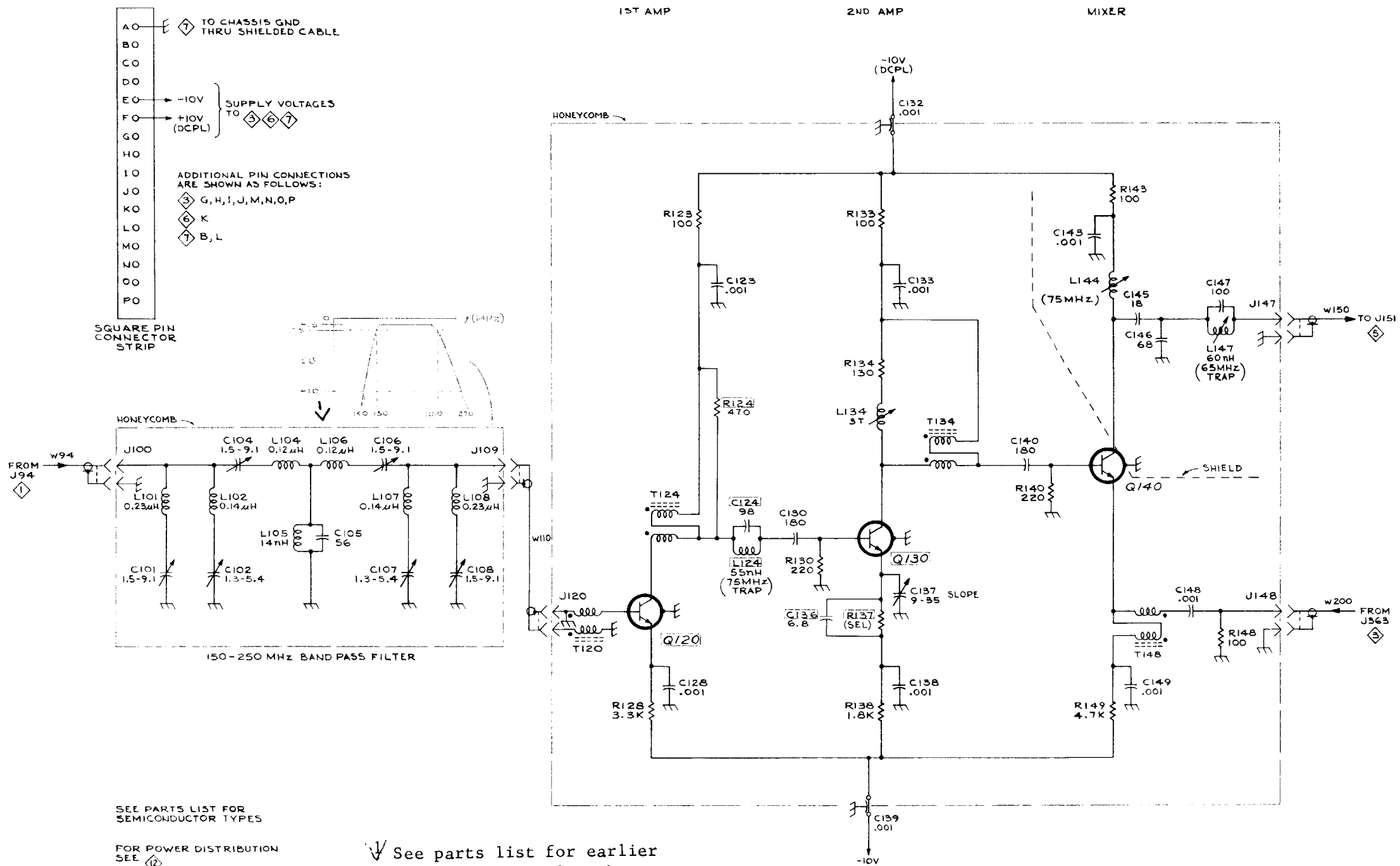

AO TO CHASSIS GND THRU SHIELDED CABLE.  
 BO  
 CO  
 DO  
 EO -10V  
 FO +10V (DCPL)  
 GO  
 HO  
 IO  
 JO  
 KO  
 LO  
 MO  
 NO  
 OO  
 PO

SUPPLY VOLTAGES TO ③ ⑥ ⑦

ADDITIONAL PIN CONNECTIONS ARE SHOWN AS FOLLOWS:  
 ③ G, H, I, J, M, N, O, P  
 ⑥ K  
 ⑦ B, L

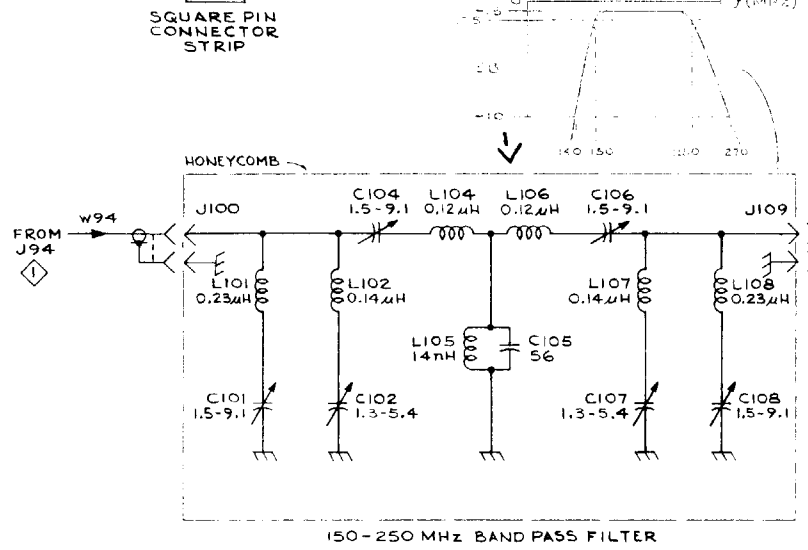

SEE PARTS LIST FOR SEMICONDUCTOR TYPES  
 FOR POWER DISTRIBUTION SEE ⑫

REFERENCE DIAGRAMS:  
 ① RF SECTION  
 ② SWEEPER CIRCUITS  
 ③ IF ATTENUATORS  
 ④ NARROW BAND AMPLIFIER  
 ⑤ VARIABLE RESOLUTION AMPLIFIER  
 ⑥ POWER DISTRIBUTION

See parts list for earlier values and serial number ranges of parts, also component values encircled are included.

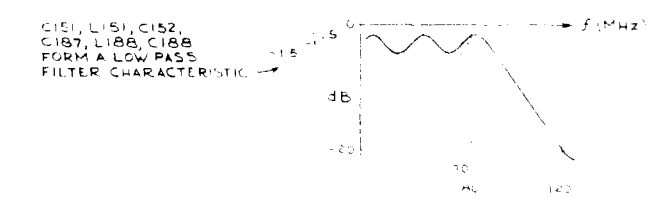
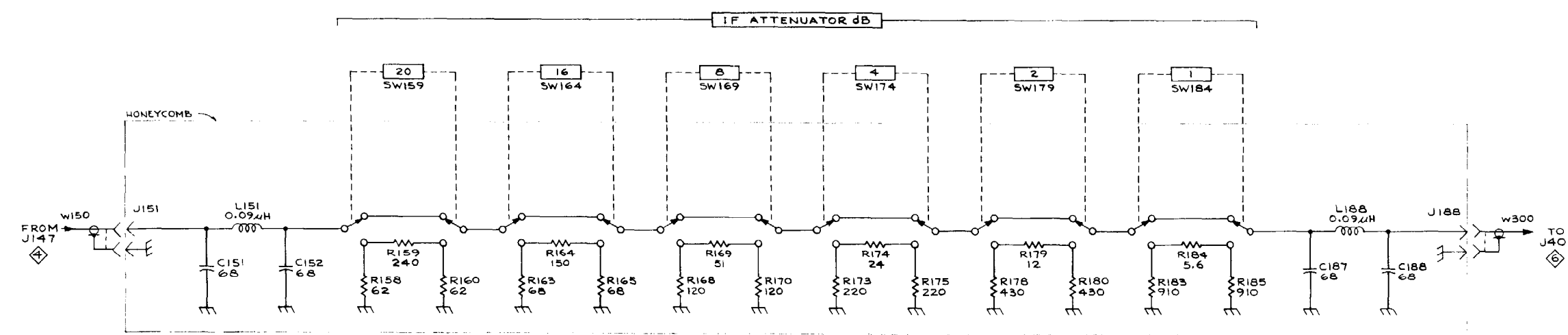

REFERENCE DIAGRAM:  
 ⬠ WIDE BAND AMPLIFIER  
 ⬡ NARROW BAND AMPLIFIER



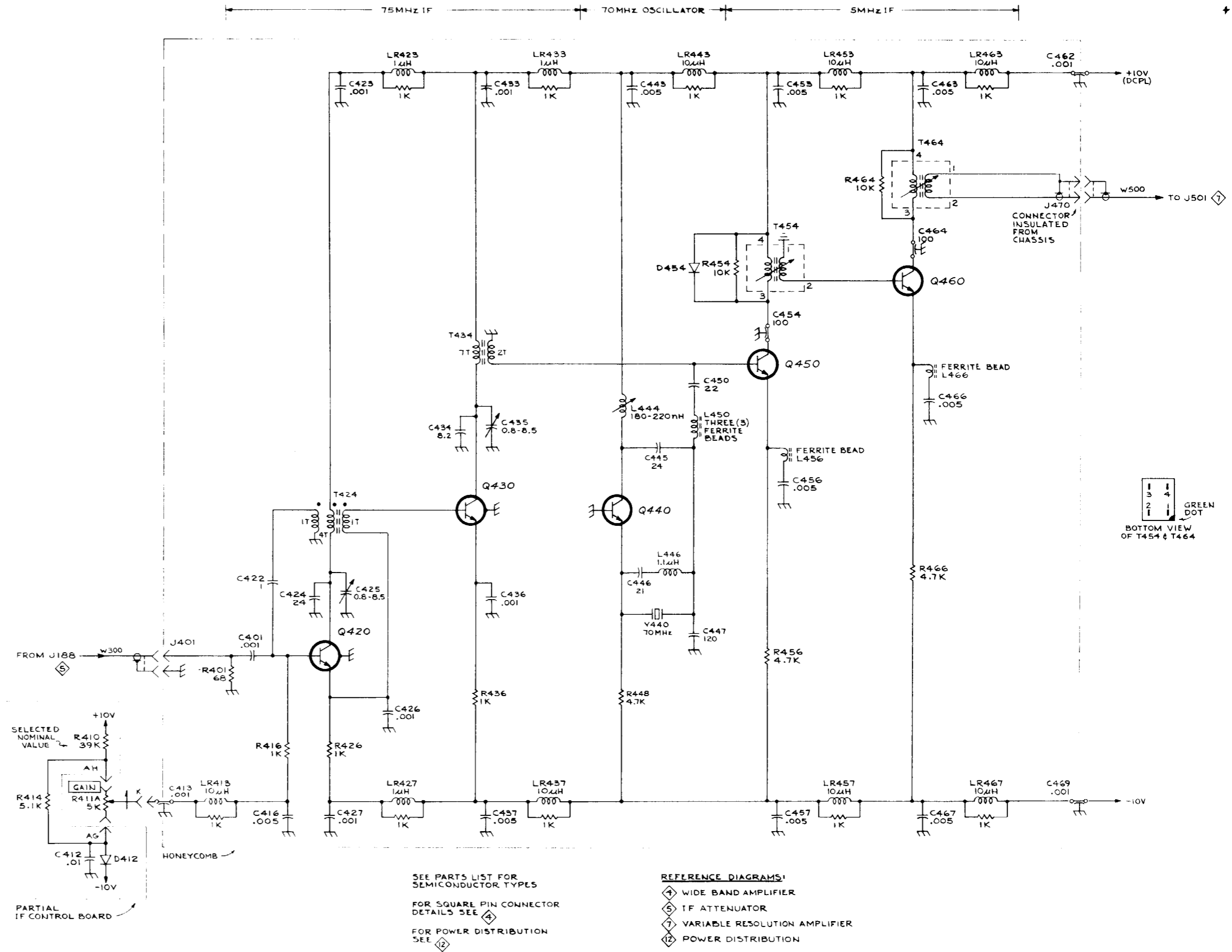

TYPE 491 SPECTRUM ANALYZER

A<sub>1</sub>

NARROW BAND AMPLIFIER 1166

SEE PARTS LIST FOR SEMICONDUCTOR TYPES  
 FOR SQUARE PIN CONNECTOR DETAILS SEE  
 FOR POWER DISTRIBUTION SEE

- REFERENCE DIAGRAM:  
 WIDE BAND AMPLIFIER  
 IF ATTENUATOR  
 VARIABLE RESOLUTION AMPLIFIER  
 POWER DISTRIBUTION

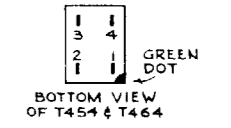

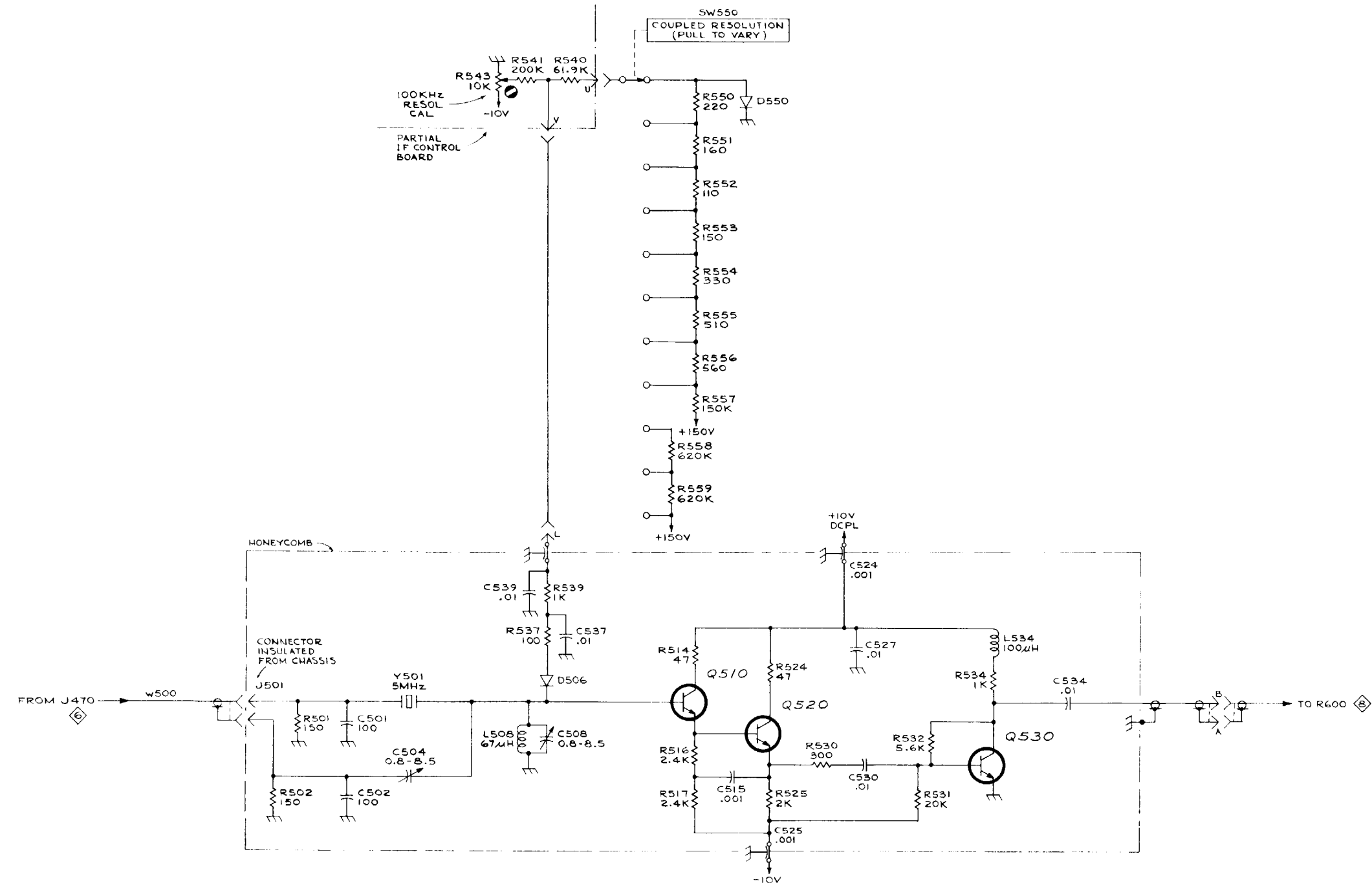

SEE PARTS LIST FOR SEMICONDUCTOR TYPES

FOR SQUARE PIN CONNECTOR DETAILS SEE ④

FOR POWER DISTRIBUTION SEE ⑤

REFERENCE DIAGRAM:

- ④ WIDE BAND AMPLIFIER
- ⑤ NARROW BAND AMPLIFIER
- ⑥ VIDEO DETECTOR & VERTICAL AMPLIFIER
- ⑦ POWER DISTRIBUTION

TYPE 491 SPECTRUM ANALYZER

VARIABLE RESOLUTION AMPLIFIER ⑦ 1166

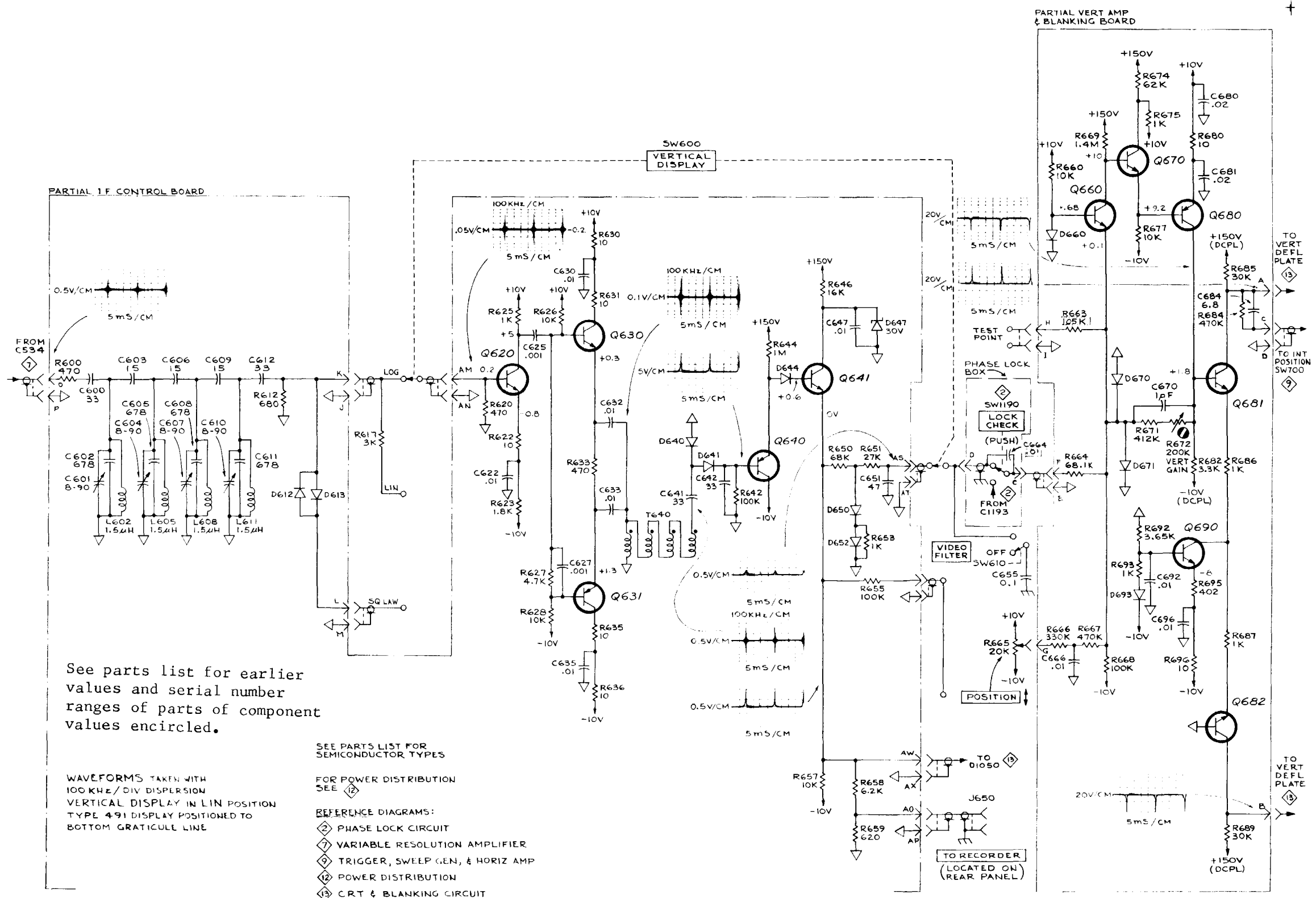

See parts list for earlier values and serial number ranges of parts of component values encircled.

WAVEFORMS TAKEN WITH 100 KHZ/DIV DISPERSION VERTICAL DISPLAY IN LIN POSITION TYPE 491 DISPLAY POSITIONED TO BOTTOM GRATICULE LINE

- SEE PARTS LIST FOR SEMICONDUCTOR TYPES
- FOR POWER DISTRIBUTION SEE (B)
- REFERENCE DIAGRAMS:
- (D) PHASE LOCK CIRCUIT
  - (E) VARIABLE RESOLUTION AMPLIFIER
  - (F) TRIGGER, SWEEP GEN, & HORIZ AMP
  - (G) POWER DISTRIBUTION
  - (H) CRT & BLANKING CIRCUIT

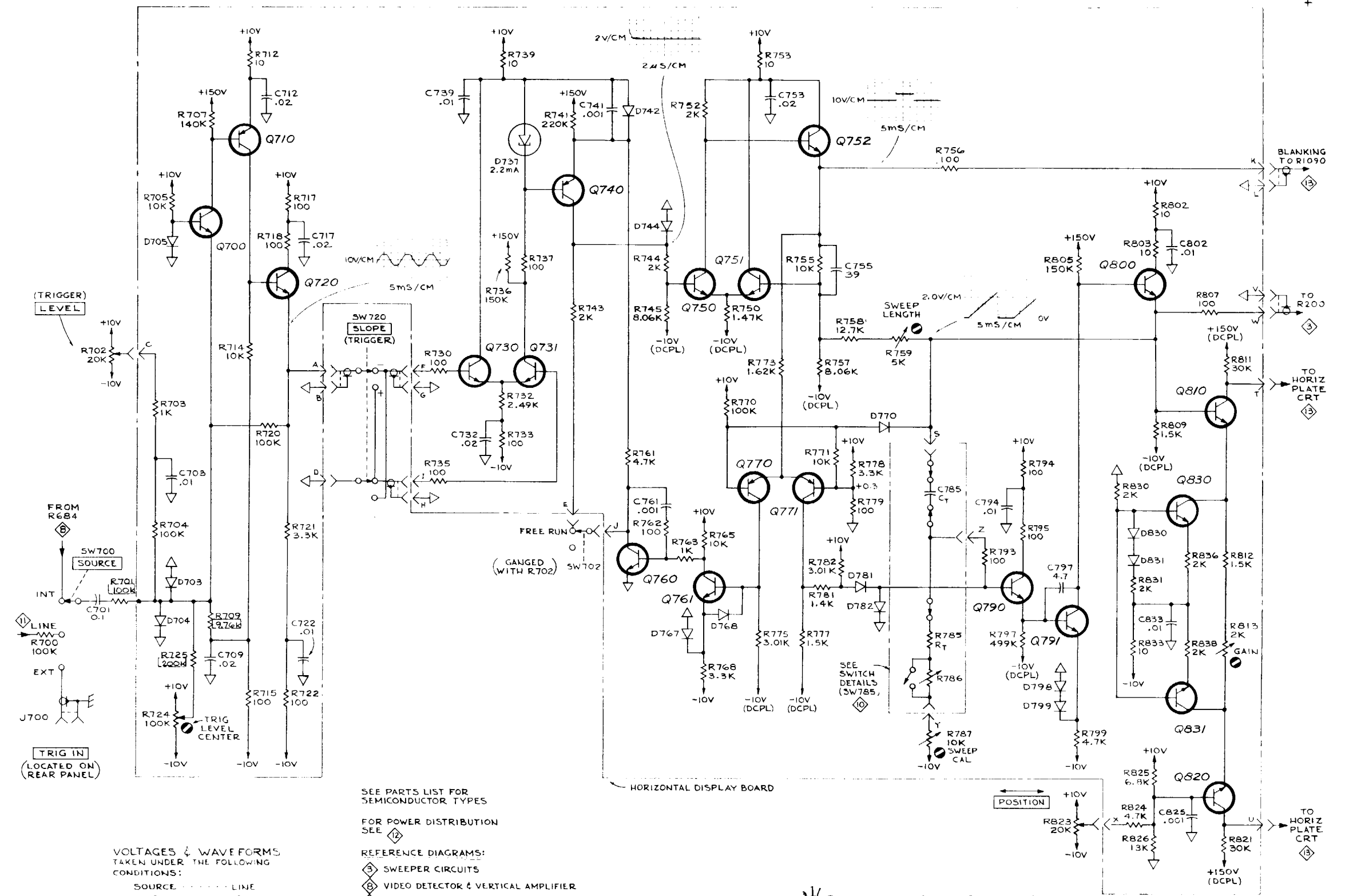

(TRIGGER LEVEL) +10V  
-10V

FROM R684

SW700 SOURCE

INT

LINE R700 100K

EXT

J700

TRIG IN (LOCATED ON REAR PANEL)

VOLTAGES & WAVEFORMS TAKEN UNDER THE FOLLOWING CONDITIONS:

SOURCE ..... LINE

LEVEL ..... CENTERED

SLOPE ..... +

TIME/DIV ..... 2mS

SEE PARTS LIST FOR SEMICONDUCTOR TYPES

FOR POWER DISTRIBUTION SEE ⑫

REFERENCE DIAGRAMS:

⑤ SWEEPER CIRCUITS

⑥ VIDEO DETECTOR & VERTICAL AMPLIFIER

⑩ TIMING SWITCH

⑪ POWER SUPPLY

⑫ POWER DISTRIBUTION

⑬ CRT & BLANKING CIRCUIT

See parts list for earlier values and serial number ranges of parts, also component values encircled.

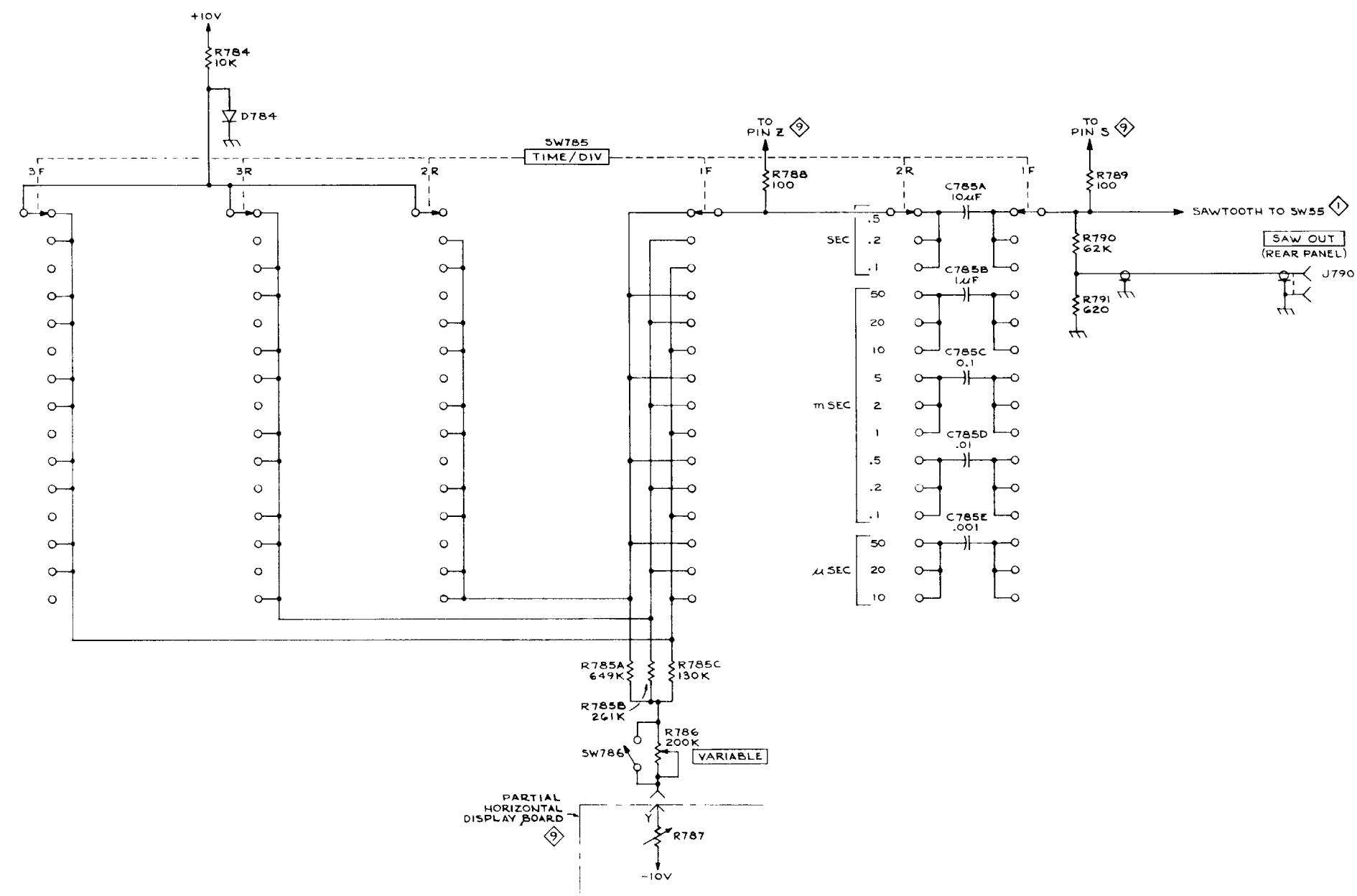

SEE PARTS LIST FOR SEMICONDUCTOR TYPES. FOR POWER DISTRIBUTION SEE (12)

REFERENCE DIAGRAMS:  
 (1) RF SECTION  
 (9) TRIGGER, SWEEP GEN & HORIZ AMP  
 (12) POWER DISTRIBUTION

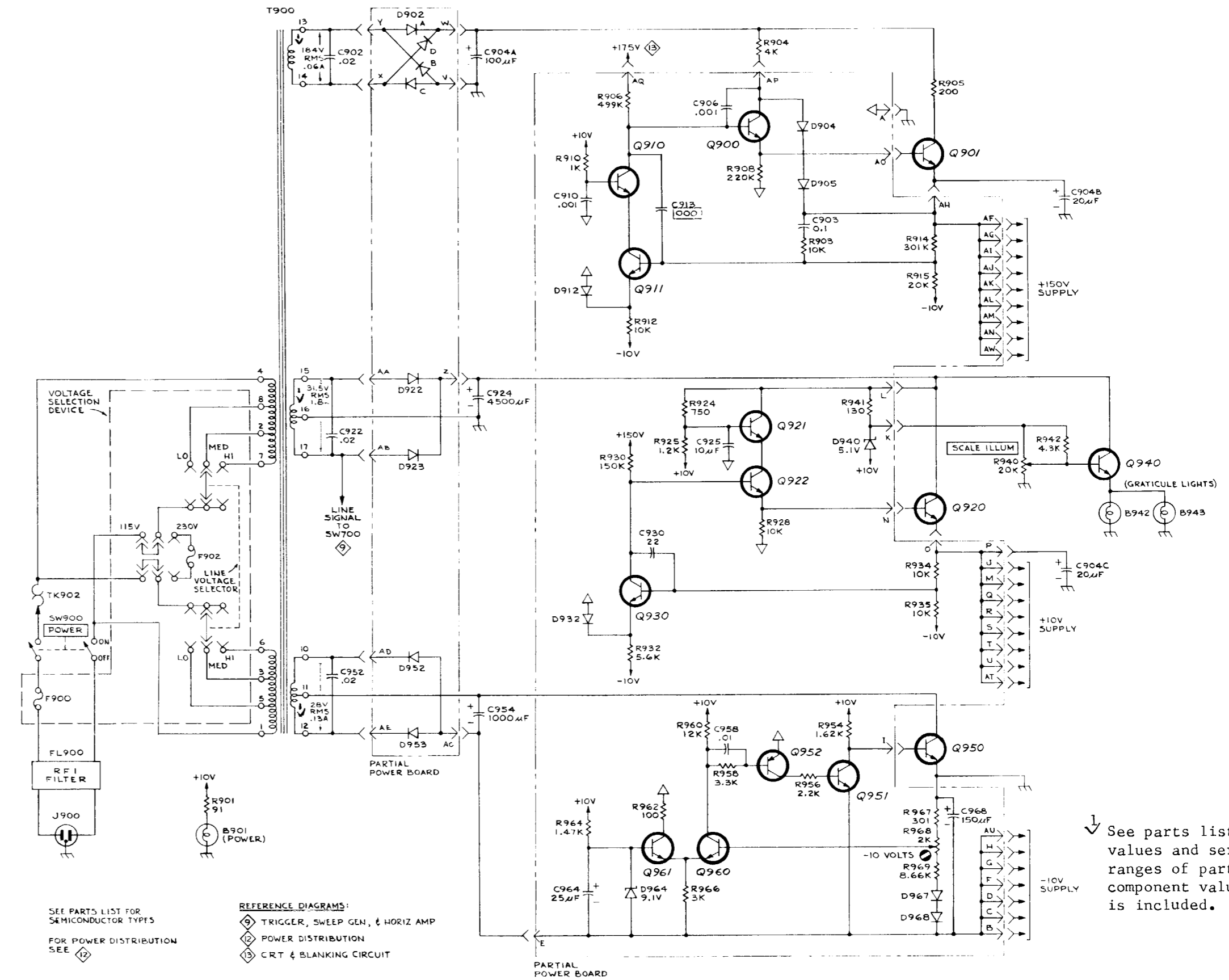

See parts list for earlier values and serial number ranges of parts, also component value encircled is included.

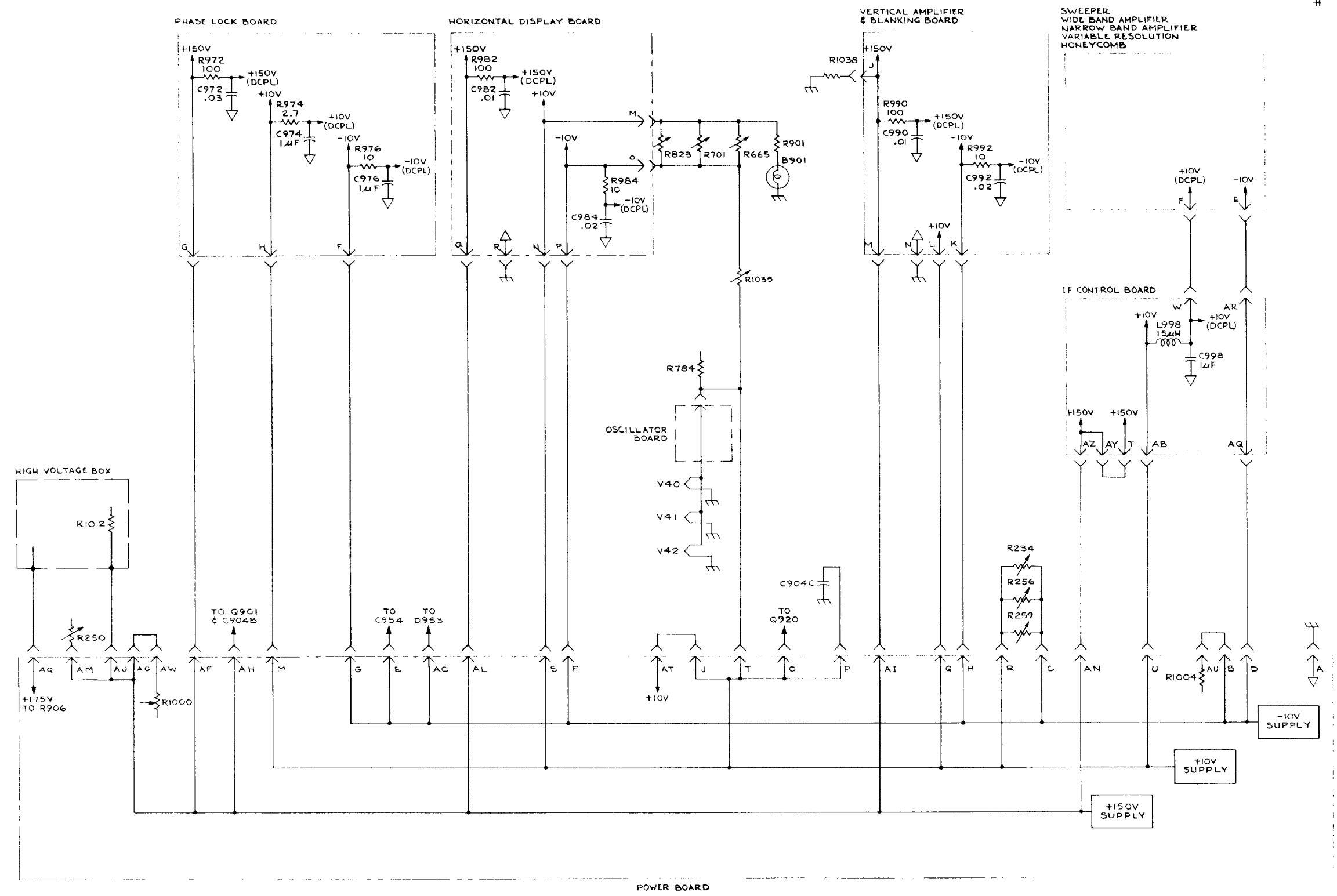

TYPE 491 SPECTRUM ANALYZER

A<sub>1</sub>

POWER DISTRIBUTION 167

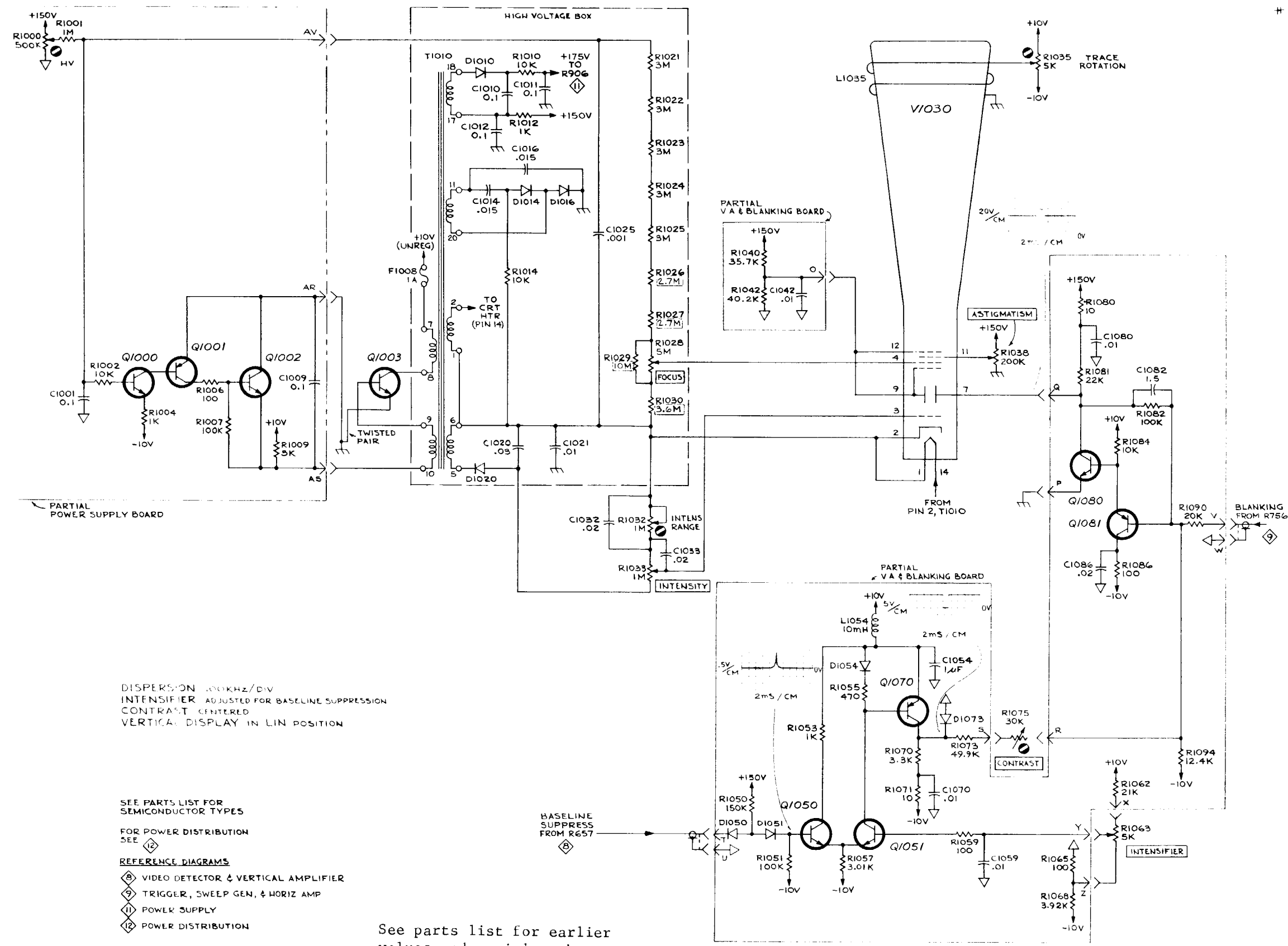

DISPERSION 100KHZ/DIV  
 INTENSIFIER ADJUSTED FOR BASELINE SUPPRESSION  
 CONTRAST CENTERED  
 VERTICAL DISPLAY IN LIN POSITION

- SEE PARTS LIST FOR SEMICONDUCTOR TYPES
- FOR POWER DISTRIBUTION SEE [Symbol]
- REFERENCE DIAGRAMS
- [Symbol] VIDEO DETECTOR & VERTICAL AMPLIFIER
  - [Symbol] TRIGGER, SWEEP GEN, & HORIZ AMP
  - [Symbol] POWER SUPPLY
  - [Symbol] POWER DISTRIBUTION

See parts list for earlier values and serial number ranges of parts of component values encircled.



FIG. 1 FRONT

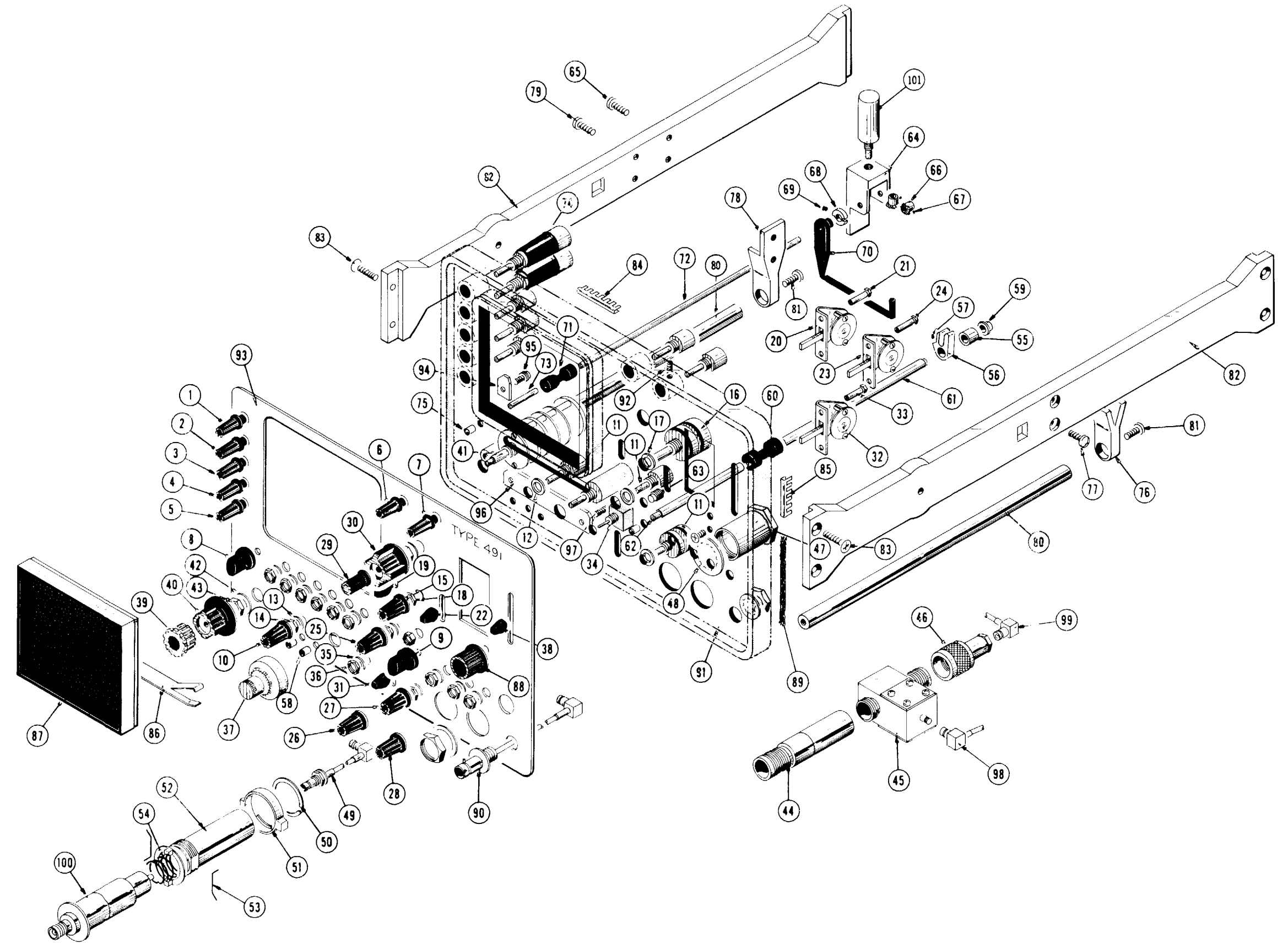

FIG. 2 REAR

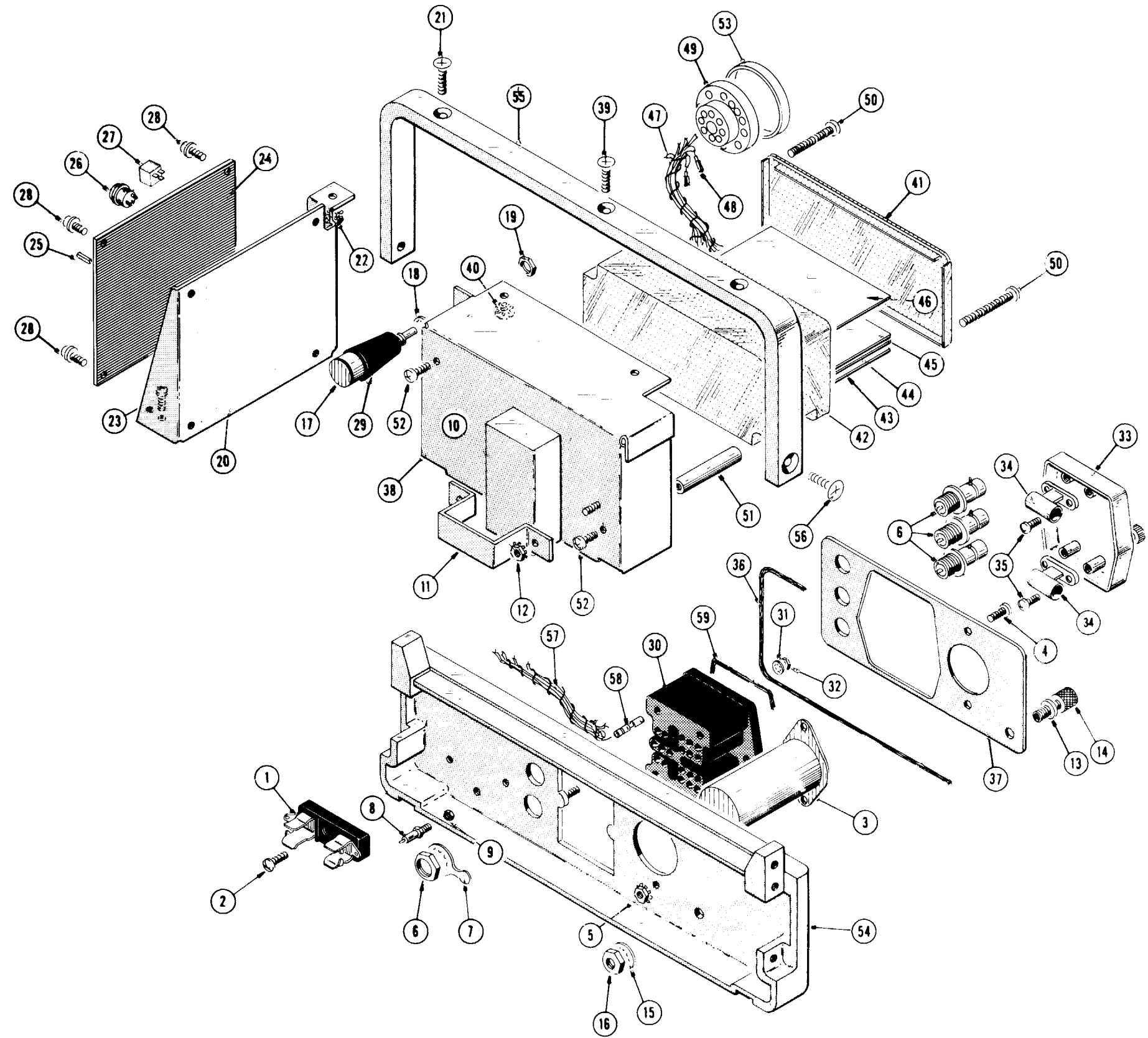

FIG. 3 IF CHASSIS & PHASE LOCK ASSEMBLIES

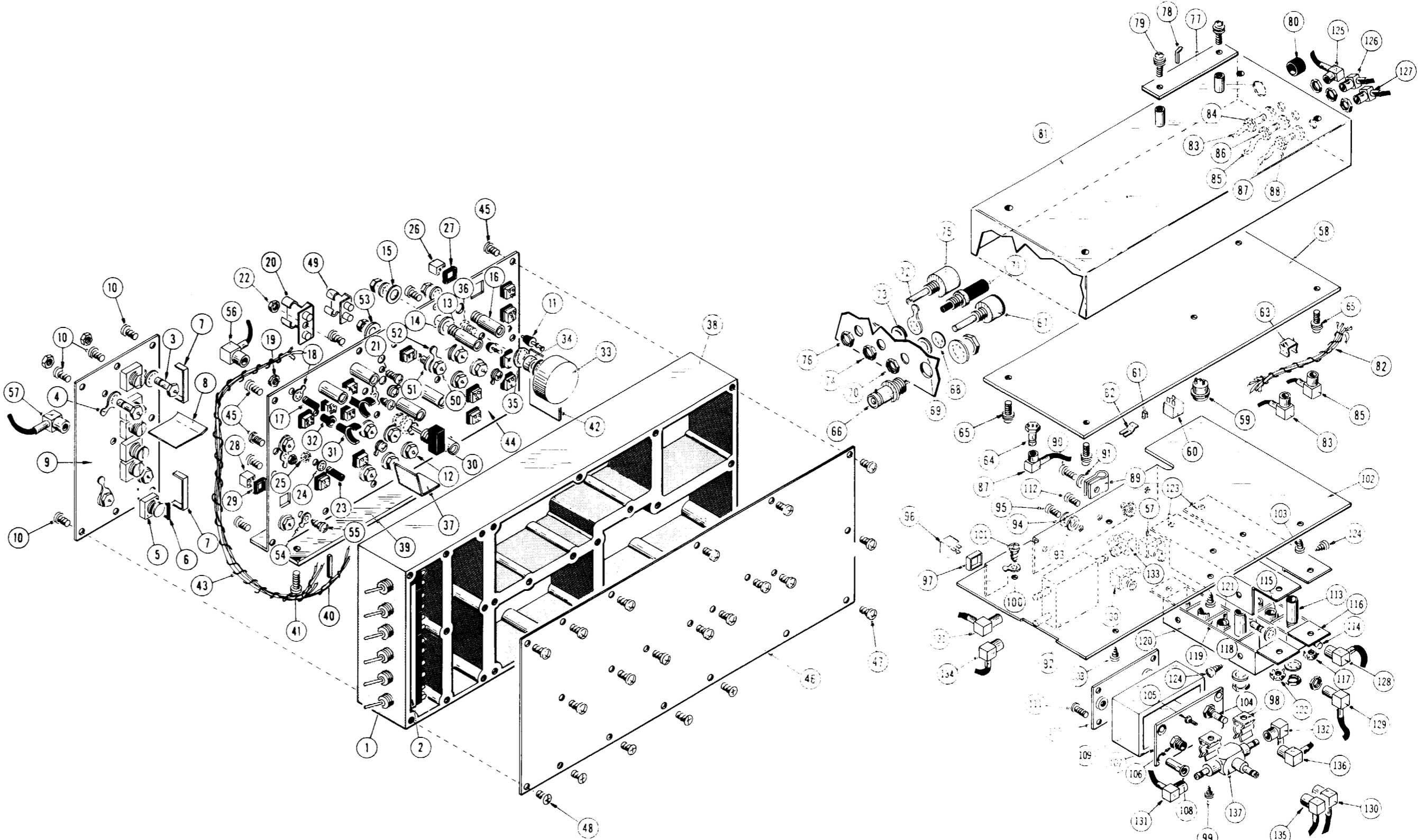

FIG. 4 POWER CHASSIS

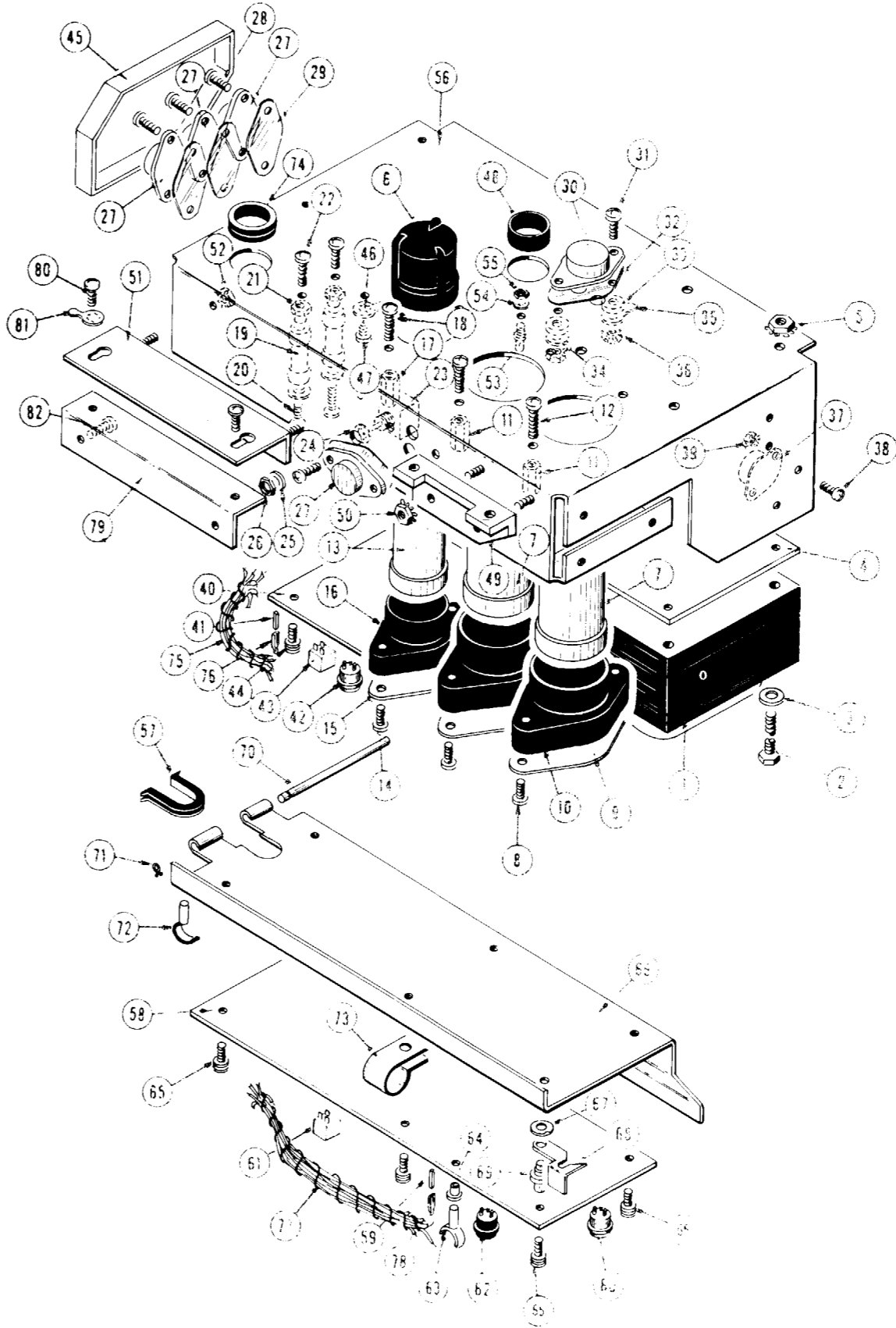
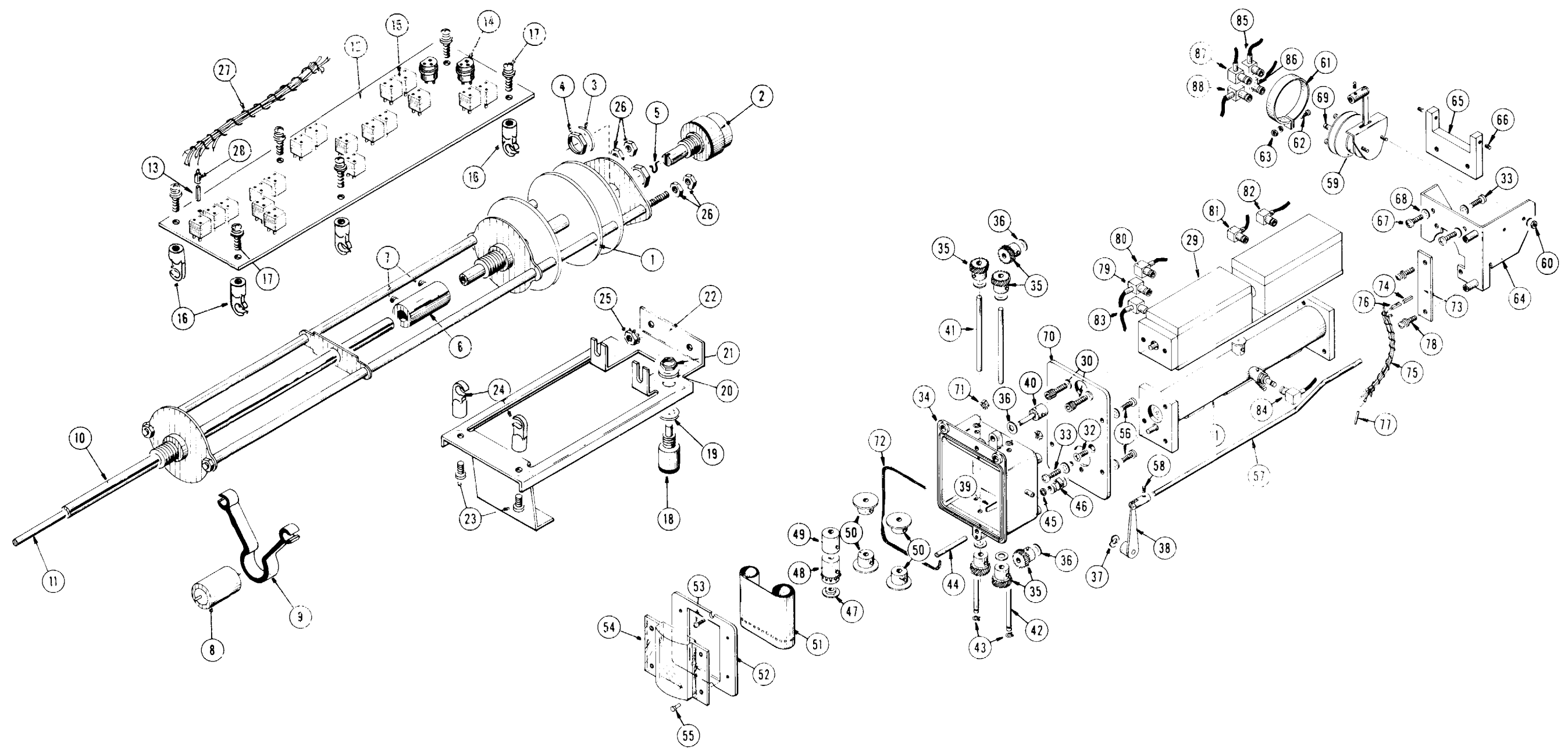

FIG. 5 TIME/DIV SWITCH & OSCILLATOR ASSEMBLIES

+



+C

FIG. 6 CRT SHIELD ASSEMBLY

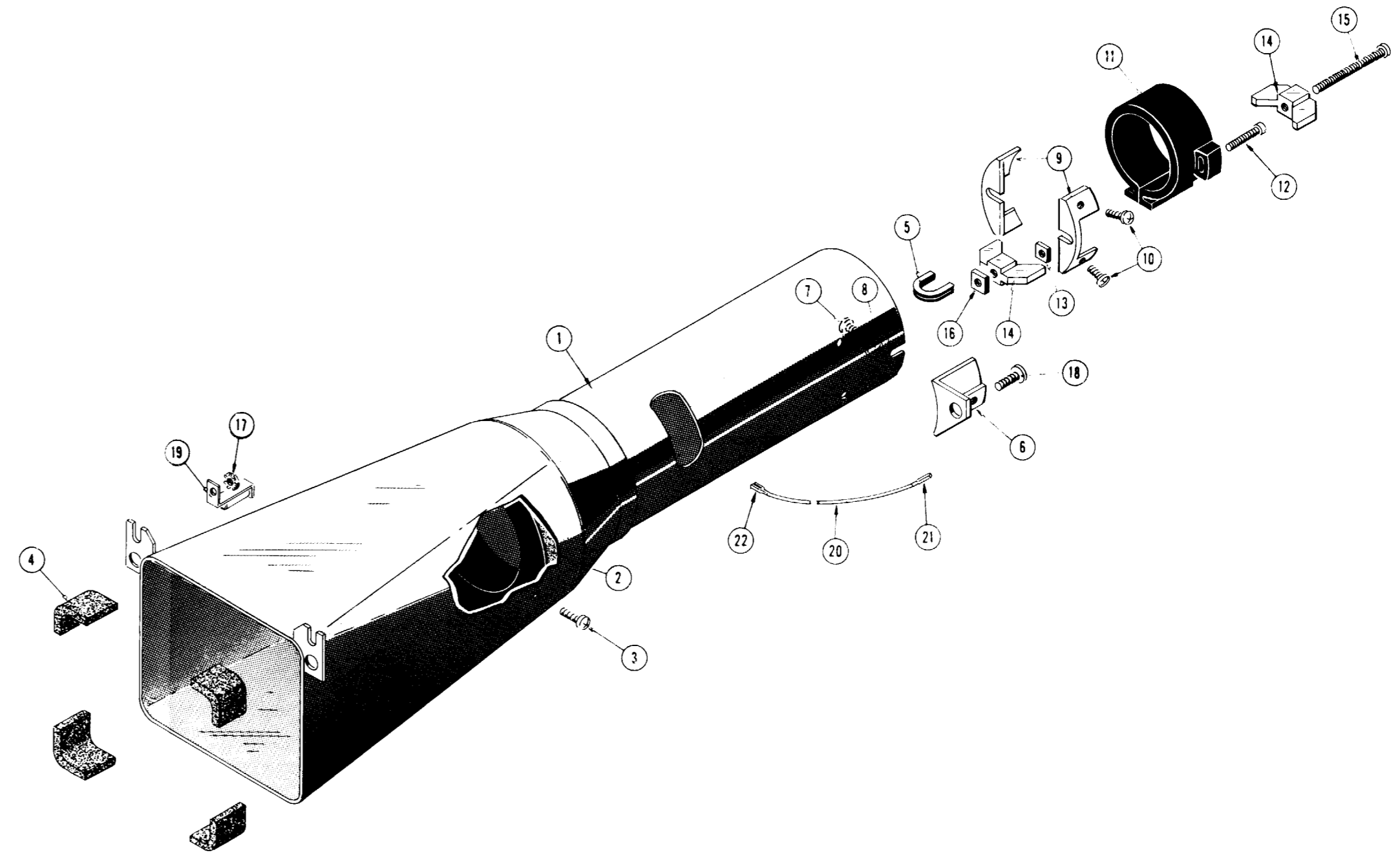

FIG. 7 CABINET ASSEMBLY & HANDLE

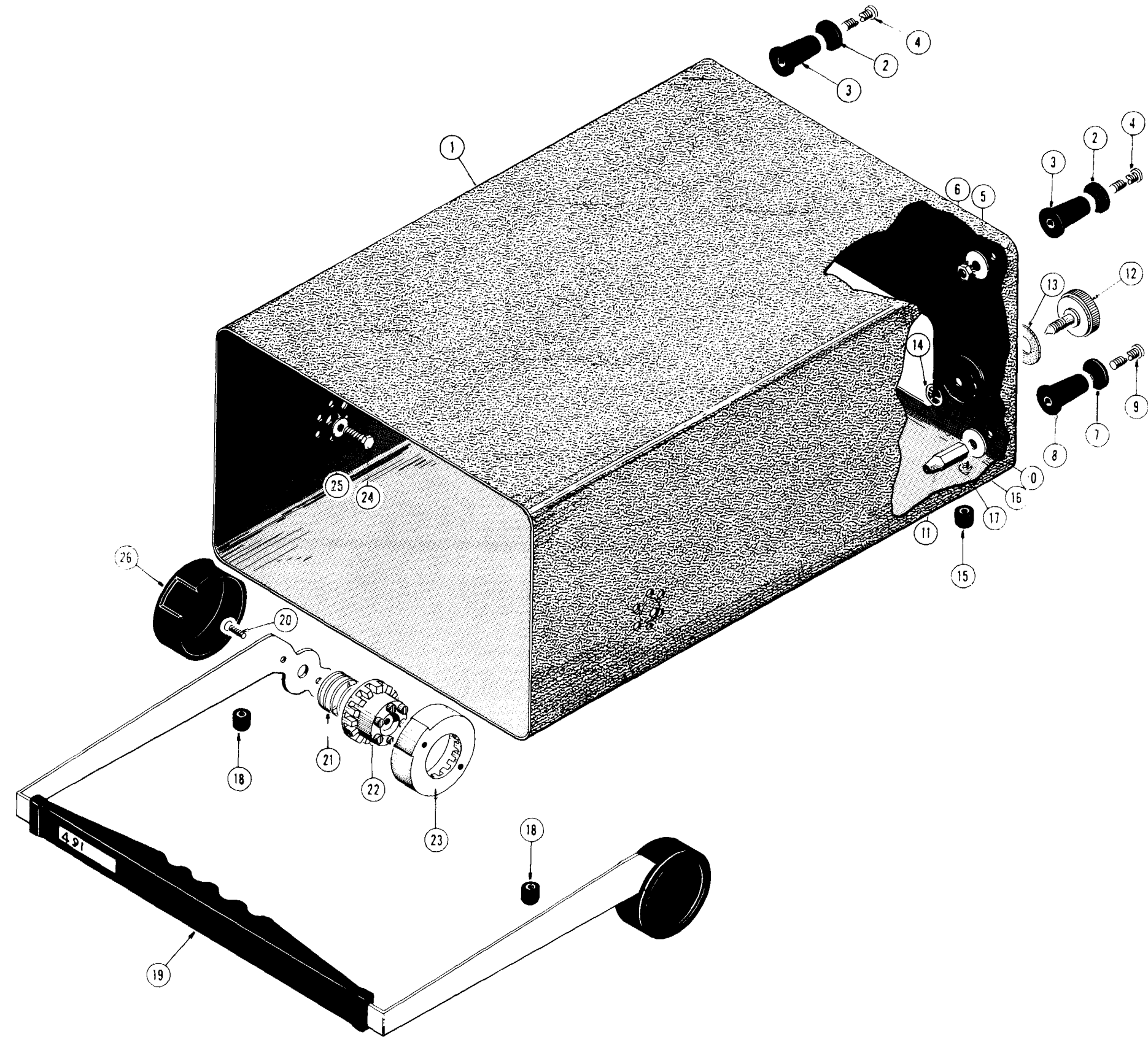
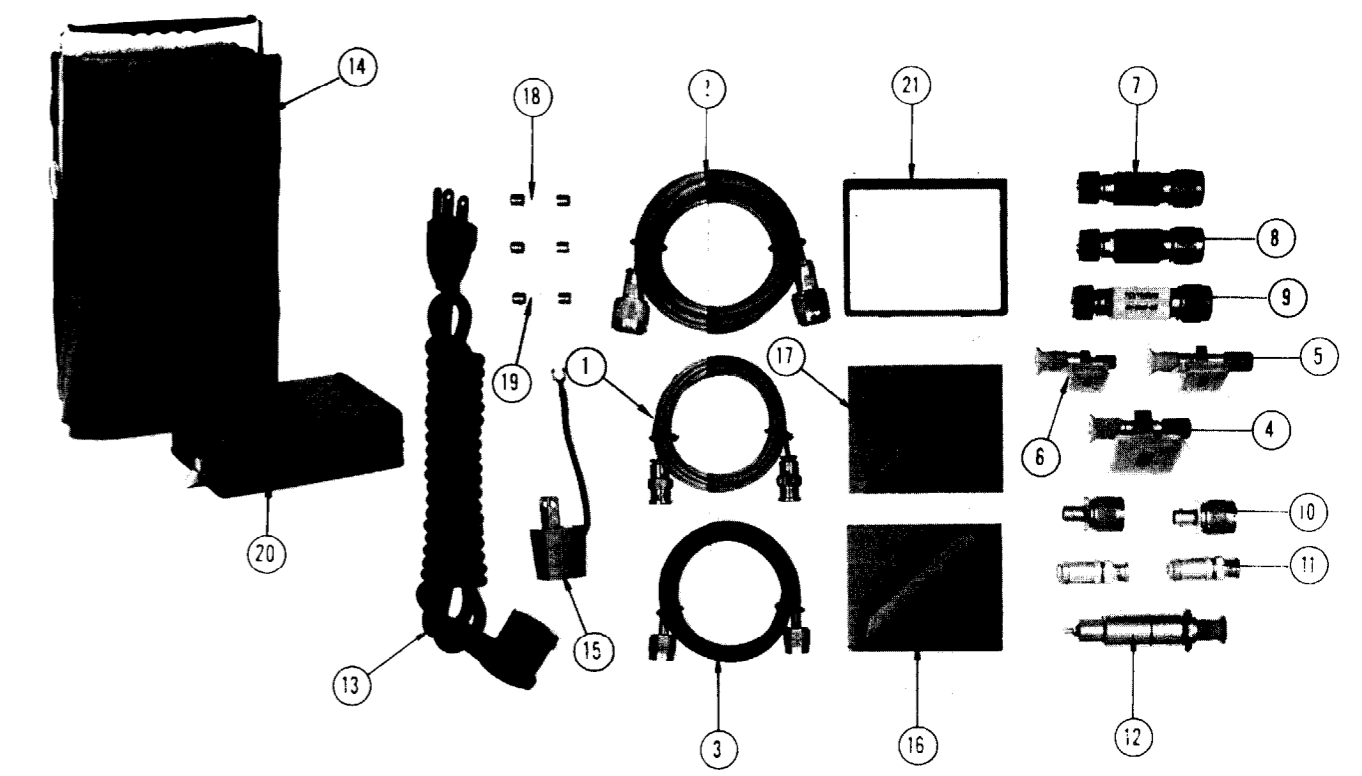

FIG. 8 491 STANDARD ACCESSORIES

Fig. & Index No.	Tektronix Part No.	Serial/Model No.		Q	Description
		Eff	Disc		
8-1	012-0113-00			1	CABLE, BNC, miniature, coaxial, 6 feet
-2	012-0114-00			1	CABLE, coaxial, 6 feet
-3	012-0115-00			1	CABLE, TNC, coaxial, 2 feet
-4	119-0097-00			1	MIXER, wave guide, 12.4 to 18.0 GHz
				-	mixer includes:
				1	DIODE, silicon (see Electrical Parts List D82)
-5	119-0098-00			1	MIXER, wave guide, 18.0 to 26.5 GHz
				-	mixer includes:
				1	DIODE, silicon (see Electrical Parts List D84)
-6	119-0099-00			1	MIXER, wave guide, 26.5 to 40.0 GHz
				-	mixer includes:
				1	DIODE, silicon (see Electrical Parts List D86)
-7	011-0085-00			1	ATTENUATOR, 10 dB
-8	011-0086-00			1	ATTENUATOR, 20 dB
-9	011-0087-00			1	ATTENUATOR, 40 dB
-10	103-0045-00			2	ADAPTER, connector, type N male to BNC female
-11	103-0058-00			2	ADAPTER, connector, type N female to BNC male
-12	119-0104-00			1	ADAPTER, plug
<del>-13</del>	161-0024-03			1	CORD, power, 18 ga, 8 feet, 3 conductor
-14	016-0074-01			1	COVER, rain
-15	103-0013-00			1	ADAPTER, power cord, 3 to 2 wire
-16	378-0558-00			1	FILTER, light, blue
-17	378-0559-00			1	FILTER, light, amber
-18	159-0022-00			2	FUSE, fast blo, 1 A, 3AG
-19	159-0025-00			1	FUSE, fast blo, 1/2 A, 3AG
-20	200-0633-03			1	COVER, front (see data sheet)
-21	354-0248-00			1	RING, ornamental
-	386-0118-00			1	PLATE, protector (not shown)
-	070-0598-00			2	MANUAL, instruction (not shown)

©

FIG. 8 491 STANDARD ACCESSORIES



+ A





